

2024



For all liquids

Stainless steel tanks for drinks,
food, plant construction
and industrial application



Open top tanks
(pressureless)



B0
page 10



F01
page 12



F02
page 12



F0
page 14

Closed tanks
(pressureless)



UF
page 20



BD
page 22



FD
page 24



FD-S
page 26



FD-ZKG
page 28



FS-M0
page 30

Tanks for mixing,
transportation
and storage
(pressureless)



S0-Z
page 64



R0-Z
page 66



K0
page 68



SD-T
page 70



LD-T
page 72



ST-T
page 74

Pressure tanks



KZE
page 84



FD-1.2B
page 94



ZKG-1.2B
page 96



FD-2.5B
page 98



ZKG-2.5B
page 100



ZKG-3B
page 102

Black Eye
(pressureless)



Black Eye
page 126



AS-MO
page 30



FS-MO
page 38



RS-MO
page 48



RA-MO
page 48



RS-MO-Q
page 54



RA-MO-Q
page 54



MS-MO
page 58



FD-B
page 76



FD-MBT
page 78



FS-MO-1B
page 108



FS-MO-3B
page 116



FS-MO-8B
page 122

Compatible double jackets,
cooling plates and heat exchanging
plates can be found on page 128,
accessories on Seite 166

Speidel's proverbial quality

Since we never do things by halves, Speidel is first choice for high quality stainless steel tanks. Their surfaces are super-smooth, their weld seams are jointless and every detail is perfect.

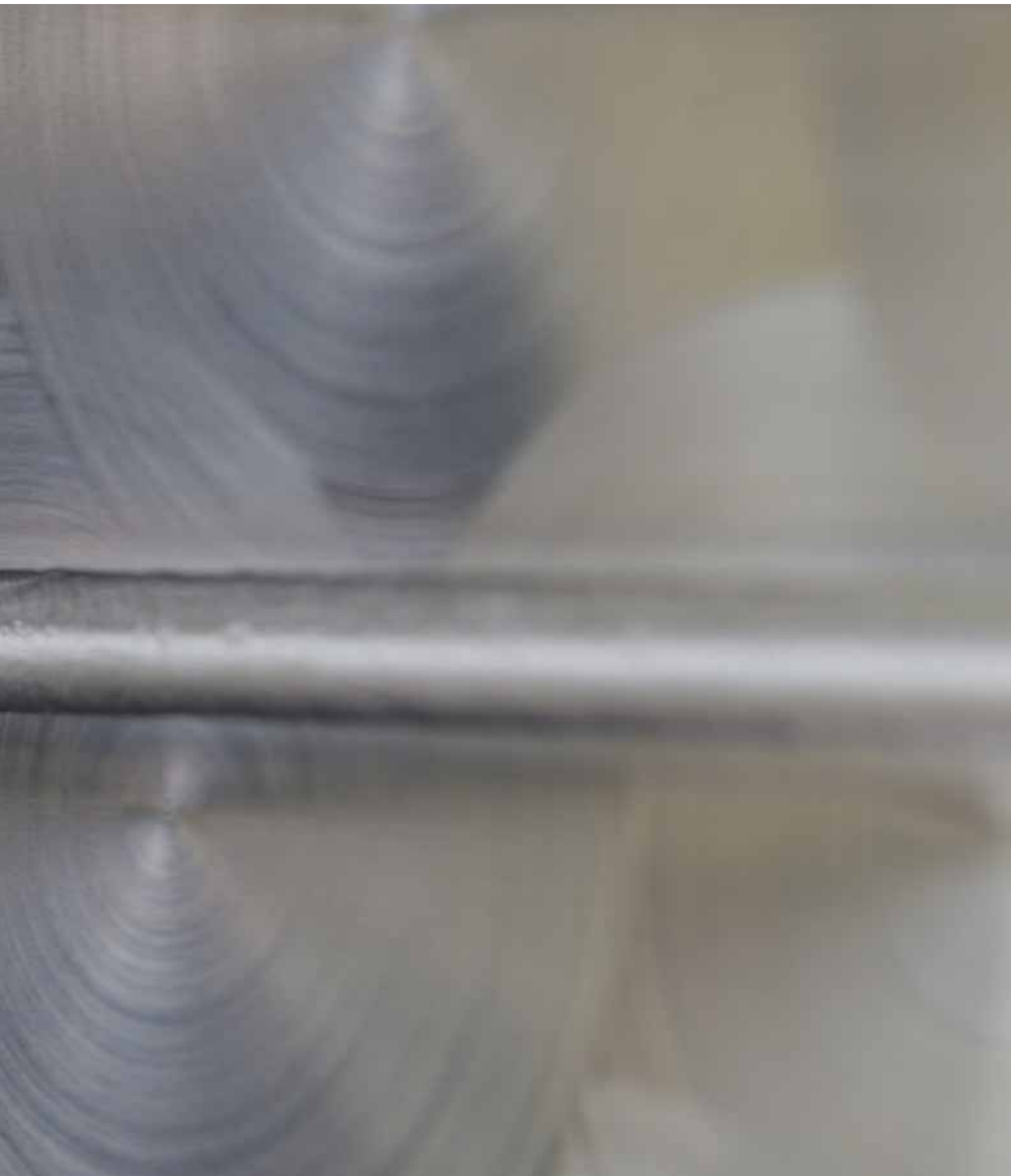

A good decision



100 % CO₂-free



» Customer stories

We can tell you
lot – here
our customers
have their say.



» Durable

Anyone who buys a stainless steel tank is not a beginner, but a professional. You want and need to be able to work with it properly – for years. It's a good thing that the high quality makes our containers so durable, because you should also be able to enjoy them for a lifetime with proper care.

» User-friendly

At Speidel, we make sure that our products make your daily work easier. Highly smooth inner walls and perfect welds reduce the build-up of tartar or impurities and simplify cleaning. The tanks are also easy to clean without chemicals. This is an advantage that will delight you year after year.

» Reliable

Our tanks are so precisely crafted that a Speidel manhole door fits every Speidel manhole. The manhole door has a vulcanized seal that is neutral in taste and resistant to alcohol and provides a reliable sealing. All tanks are tested at the factory with a water fill sample to ensure quality and warranty. In addition, the dimensional accuracy is almost identical from tank to tank. You can rely on Speidel quality.

» Environmentally conscious

Not only quality, but also environmentally conscious production is important to us. We cover 25 % of our electricity requirements from our own generation and thus avoid approx. 270 tons of CO₂ annually. The remaining part of our electricity requirements that we do not generate ourselves comes from renewable energy sources and is 100 % CO₂-free electricity. So there are no CO₂ emissions for the production of a Speidel container.

» Sustainable

We do everything we can to make our containers as durable as possible. The quality of the raw material and the excellent workmanship show our attitude not to produce disposable articles. Anything that lasts a long time does not need to be replaced, which saves raw materials and energy. That's why we source most of our primary material from Germany. This means reliable sources of supply and short delivery routes with the best quality.

» Economical

In the interplay of manufacturing and cleaning, these are probably the most sustainable tanks on the market today; saving you time, money and resources in later operation. With automated machining and welding machines, we ensure the best price-performance ratio. Compared to other tanks, this means that a Speidel tank pays for itself within the first few years.



» Hygienic

In the design of our tanks, we take care to avoid dead spaces. Large corner radii as well as necking ensure that nothing gets stuck. With increasing requirements and regulations, hygiene has become even more important. For this, Speidel tanks are simply perfect.

» Cool

For effective temperature control, we provide our containers with a laser-welded double jacket. The double jackets are manufactured in-house at Speidel and can easily withstand an operating pressure of up to 6 bar. Due to the easy and safe installation, our tanks are recommended by leading refrigeration equipment manufacturers.

» Made in Germany

The Speidel family business has been around for 111 years. Already in fourth generation, Stefan and Fabian Speidel are building on Swabian virtues at the Ofterdingen site. Here, durable and high-quality containers are manufactured that you will enjoy for a lifetime.

» Safe

Stable feet with optimal force transmission ensure a high level of stability. safety. Vessels with agitator and control are manufactured according to European Machinery Directive EC 2006 / 42.

Open top tanks





Tank B0



The tank B0 is often described as 'starter kit'. It is, however, also utilised by advanced users for small quantities. Its outstanding price-performance ratio and handy size have made it so popular that the 'B0' is now being used all over the world.

The tanks have a strengthening rim. The flat base ensures high stability, characteristic of all Speidel tanks.

APPLICATION RANGE (PRESSURELESS)

- Fermentation
- Mixing
- Storage
- Maturation
- Processes

Ideal for

- Beverages
- Food
- Plant construction
- Industry



Storage rack for more convenient handling can be found in the accessories on page 184





STANDARD EQUIPMENT FOR TANK BO

- For non-pressurized use
- AISI304 stainless steel, outside and inside surface IIId (2R)
- Open tank top with strengthening rim
- Flat tank bottom
- External liter scale

Width of rim

- Up to 290 liter capacity = approx. 17 mm
- From 650 liter capacity = approx. 42 mm

Racking outlet

- Up to tanks of 550 mm \varnothing internal thread G 3/4" (BSP) with plastic blank bung
- From tanks of 630 mm \varnothing external thread G 1" (BSP) with plastic blank bung

DIMENSIONS OF TANK BO

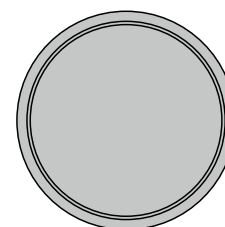
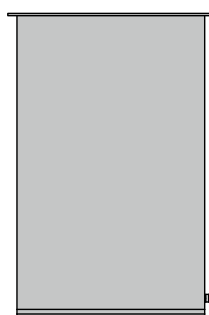
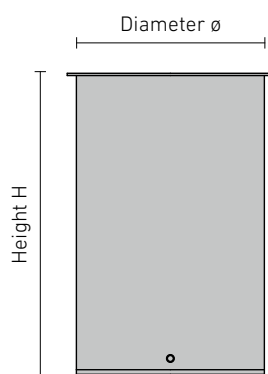

Capacity

liter

ø

mm

H

mm

Order No.

loose

110	440	765	BO -044 -0110
220	550	999	BO -055 -0220
290	630	999	BO -063 -0290
650	820	1,328	BO -082 -0650
1,100	1,000	1,493	BO -100 -1100
1,600	1,200	1,493	BO -120 -1600

Tank F01 / F02



The popular F0 tanks are mostly used for open fermentation. Like all other Speidel tanks, they have been well proven and tested and their quality is outstanding.

The tank's top is open and has a stable reinforced edge. Optionally, the tank can be covered with a slip lid (see accessories).

APPLICATION RANGE (PRESSURELESS)

- Fermentation
- Mixing
- Storage
- Maturation
- Processes

Ideal for

- Beverages
- Food
- Plant construction
- Industry



STANDARD EQUIPMENT FOR TANK F01 / F02

- For non-pressurized use
- AISI 304 stainless steel, surface IIIId (2R), marbled outside
- Tank open on top with strengthening rim
- Vaulted tank bottom
- External liter scale
- Standing on three legs

Width of rim

- Up to 300 liter capacity = approx. 17 mm
- From 530 liter capacity = approx. 42 mm

Racking outlet F01

- Up to tank- ϕ of 550 mm internal thread 3/4" (BSP) with plastic blank bung
- From tank- ϕ of 630 mm external thread G 1" (BSP) with plastic blank bung

Bottom outlet F01

- Up to tank- ϕ of 550 mm total outlet neck internal thread G 3/4" (BSP) with plastic blank bung
- From tank- ϕ of 630 mm bottom outlet neck external thread G 1" (BSP) with plastic blank bung

Racking outlet F02

- Plain surface with drilled hole ϕ 48 mm (to hold weld-on thread NW 40, NW 50 DIN 11851)
- In case of ϕ 630 mm reinforcement moulded out of the tank's casing
- In case of ϕ 820 mm with welded-on reinforcing plate

Bottom outlet F02

- Total outlet neck with external thread NW 40 DIN 11851

DIMENSIONS OF TANK F01 / F02

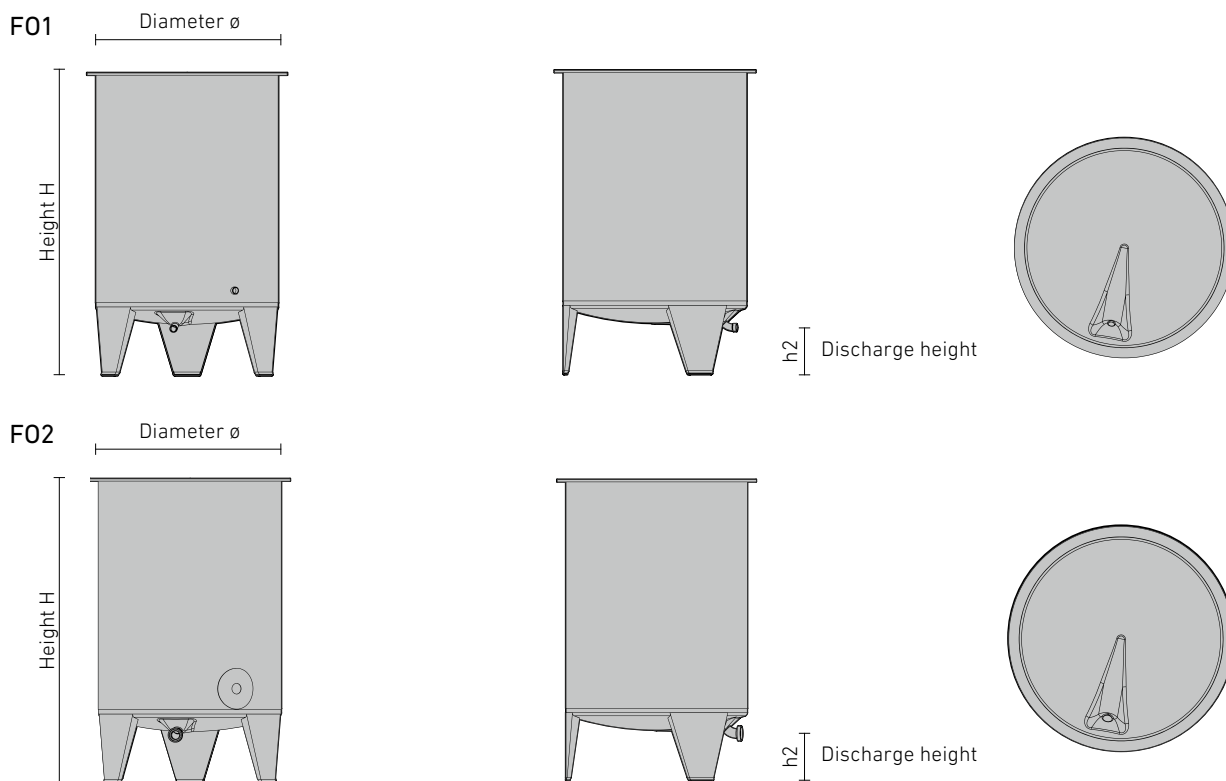

Capacity liter	H mm	h2 mm	ϕ mm	Order No. F01	ϕ mm	Order No. F02
220	1,382	325	550	F01 -055 -220	-	-
300	1,384	315	630	F01 -063 -300	630	F02 -063 -300
530 *	1,361	205	820	F01 -082 -530	820	F02 -082 -530
675 *	1,620	205	820	F01 -082 -675	820	F02 -082 -675
910 *	2,109	205	820	F01 -082 -910	820	F02 -082 -910

* Also deliverable with the useful PE-base for transportation and storage instead of sturdy legs (see page 184)

Tank FO



The bigger fermentation tank FO is available for contents from 1,100 to 25,000 liter and with a diameter from 1,000 mm to 2,400 mm. The tank also has Speidel's typical easy-to-clean surfaces and outstanding overall quality.

Speidel is one of the few who know how to make round tanks. Thanks to their strengthening rim and perfect finishing our tanks are never in a tight spot. Their outstanding accuracy makes our tanks one-of-a-kind.

APPLICATION RANGE (PRESSURELESS)

- Fermentation
- Mixing
- Storage
- Maturation
- Processes

Ideal for

- Beverages
- Food
- Plant construction
- Industry





STANDARD EQUIPMENT FOR TANK FO

- For non-pressurized use
- AISI 304 stainless steel, surface IIIId (2R), marbled outside
- Open tank top with strengthening rim, width of rim approx. 42 mm
- Standing on three legs
- External liter scale





Racking outlet

- Reinforcing plate with drilled hole \varnothing 48 mm (to hold weld-on thread NW 40 and NW 50 DIN 11851)

Bottom outlet

- Vaulted, stable tank bottom with integrally moulded forward down-slope for complete draining, bottom outlet neck with external thread NW 50 DIN 11851
- From \varnothing 2,200 mm located in bottom centre with forward drawn discharge pipe and outlet neck with thread NW 50 DIN 11851

SET-UP EXAMPLE FOR TANK FO

Item	Order No.
 <p>Tank FO-140-2200 liter · h1 = 1,841 mm, H = 2,391 mm · Standard equipment as on page 15</p>	FO-140-2200
 <p>Racking outlet (page 172) · Welded gland with thread NW 50 DIN 11851 · With disc valve NW 50 DIN 11851</p>	KA-120D 64945
 <p>Bottom outlet (page 172) · With disc valve NW 50 DIN 11851</p>	64945
 <p>Dust lid (page 168) · Dust lid made of stainless steel with handles</p>	68692

DIMENSIONS OF TANK FO

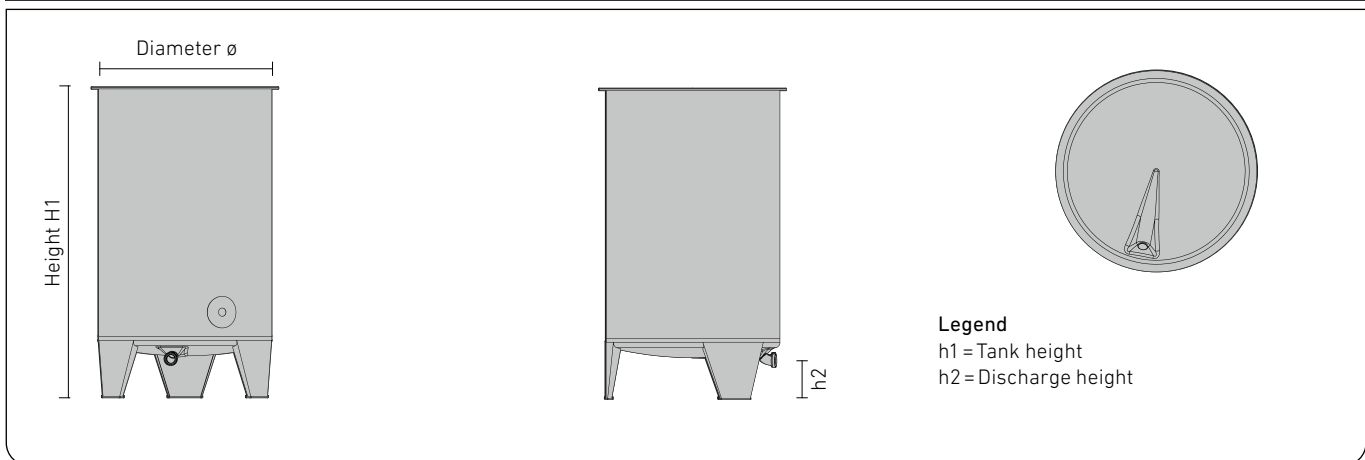

TANK FO

Capacity	∅	h1	h2	H	Order No.
liter	mm	mm	mm	mm	
1,100	1,000	1,791	210	2,216	FO-100- 1100
*					
1,600	1,200	1,831	230	2,356	FO-120- 1600
*					
2,200	1,400	1,841	240	2,391	FO-140- 2200
3,300	1,400	2,579	240	3,129	FO-140- 3300
2,850	1,600	1,873	225	2,513	FO-160- 2850
3,850	1,600	2,361	225	3,001	FO-160- 3850
4,800	1,600	2,861	225	3,501	FO-160- 4800
5,800	1,600	3,361	225	4,001	FO-160- 5800
6,800	1,600	3,849	225	4,489	FO-160- 6800
7,700	1,600	4,379	225	4,989	FO-160- 7700
8,700	1,600	4,849	225	5,498	FO-160- 8700
9,700	1,600	5,337	225	5,977	FO-160- 9700
3,700	1,800	1,883	225	2,558	FO-180- 3700
4,900	1,800	2,371	225	3,046	FO-180- 4900
6,100	1,800	2,871	225	3,546	FO-180- 6100
7,400	1,800	3,371	225	4,046	FO-180- 7400
8,600	1,800	3,859	225	4,534	FO-180- 8600
9,800	1,800	4,359	225	5,034	FO-180- 9800
11,000	1,800	4,859	225	5,534	FO-180- 11000
12,200	1,800	5,347	225	6,022	FO-180- 12200
4,500	2,000	1,913	225	2,613	FO-200- 4500
6,000	2,000	2,401	225	3,101	FO-200- 6000
7,600	2,000	2,901	225	3,601	FO-200- 7600
9,100	2,000	3,401	225	4,101	FO-200- 9100
10,600	2,000	3,889	225	4,589	FO-200- 10600
12,200	2,000	4,389	225	5,089	FO-200- 12200
13,800	2,000	4,889	225	5,589	FO-200- 13800
15,200	2,000	5,377	225	6,077	FO-200- 15200
6,000	2,200	2,240	225	2,970	FO-220- 6000
8,000	2,200	2,740	225	3,470	FO-220- 8000
9,800	2,200	3,240	225	3,970	FO-220- 9800
11,700	2,200	3,740	225	4,470	FO-220- 11700
13,500	2,200	4,240	225	4,970	FO-220- 13500
15,500	2,200	4,740	225	5,470	FO-220- 15500
17,500	2,200	5,240	225	5,970	FO-220- 17500
19,000	2,200	5,740	225	6,470	FO-220- 19000
7,200	2,400	2,280	225	3,085	FO-240- 7200
9,500	2,400	2,780	225	3,585	FO-240- 9500
11,500	2,400	3,280	225	4,085	FO-240- 11500
14,000	2,400	3,780	225	4,585	FO-240- 14000
16,000	2,400	4,280	225	5,085	FO-240- 16000
18,500	2,400	4,780	225	5,585	FO-240- 18500
20,500	2,400	5,280	225	6,085	FO-240- 20500
22,800	2,400	5,780	225	6,585	FO-240- 22800
25,000	2,400	6,280	225	7,085	FO-240- 25000

Option: Tank contact parts made of AISI 316 stainless steel
Surface IIId (2R), marbled outside
Extra charge to basic version on request

* Also deliverable with the useful PE-base for transportation and storage instead of sturdy legs (see page 184)

Tank-∅ 1,600 mm: up from 6,800 liter with box shaped legs as standard
Tank-∅ 1,800 mm: up from 8,600 liter with box shaped legs as standard
Tank-∅ 2,000 mm: up from 10,600 liter with box shaped legs as standard
Tank-∅ 2,200 mm + 2,400 mm: with box shaped legs in general

Closed tanks





Fermentation and storage barrel UF



Our fermentation and storage barrel UF is also known as universal barrel. Like the name suggests its use is really multifunctional. Mostly it is used for fermentation and storage, but also for the blending and transportation of liquids. Yet, not only liquids but any kind of individual ingredient can be stored air-tightly in this barrel.

Our clients have already shown us the most curious application purposes and sometimes we are surprised ourselves about how versatile this barrel really is. In any case: due to its high quality surface and overall outstanding quality, the barrel is always easy to clean!

APPLICATION RANGE (PRESSURELESS)

- Fermentation
- Storage

Ideal for

- Wine
- Beer
- Spirits
- All kinds of beverages



You can find neoprene insulating sleeves in the accessories on page 193



STANDARD EQUIPMENT FOR FERMENTATION AND STORAGE BARREL UF

- For non-pressurized use
- Tank made of stainless steel AISI304
- Inside and outside surface 316L
- Tightly closing tension ring lid with silicone seal
- Plastic screw connection with blind cap for fermentation top piece
- Two stainless steel carrying handles

Racking outlet

- Outlet internal thread G 3/4" with plastic blank plug

Double jacket

- Laser-welded double jacket for cooling with two connections G1" with external thread

DIMENSIONS OF FERMENTATION AND STORAGE BARREL UF

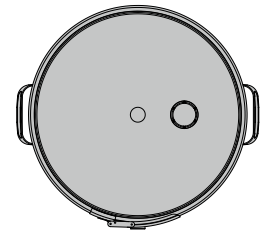
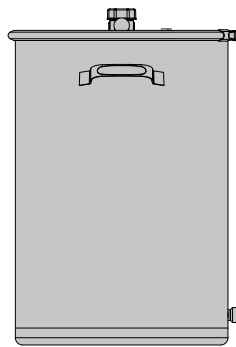
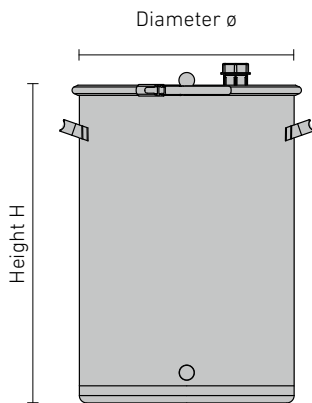

Capacity liter	Ø mm	H mm	Order No.
15	280	352	UF-028-V0001
30	350	400	UF-035-V0005
45	350	564	UF-035-V0001
60	350	692	UF-035-V0006
95	440	689	UF-044-V0001
120	440	880	UF-044-V0003

FERMENTATION AND STORAGE BARREL UF WITH DOUBLE JACKET, TWO CONNECTIONS G 1" MALE THREAD

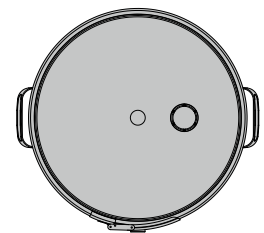
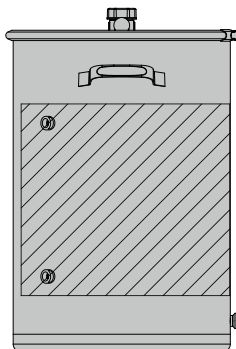
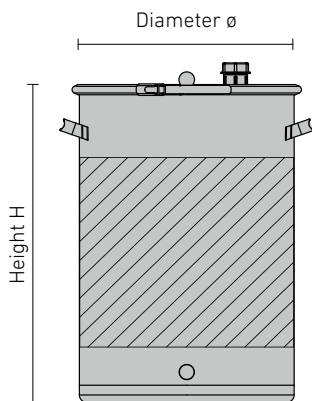

Capacity liter	Ø mm	H mm	Order No.
15	280	352	UF-028-V0003
30	350	400	UF-035-V0007
60	350	692	UF-035-V0009

Fermentation and storage tank BD



The fermentation and storage tank BD is completely made of AISI304. The tank's resistant walls, its excellent finishing and stability are typical of Speidel's characteristic quality.

The useful top opening simplifies the cleaning and the flat tank bottom allows the tank to be put on pedestals or base frames.

APPLICATION RANGE (PRESSURELESS)

- Storage
- Maturation

Ideal for

- Spirits
- Beverages
- Plant construction
- Industry



Storage rack for more convenient handling can be found in the accessories on page 184





STANDARD EQUIPMENT FOR FERMENTATION AND STORAGE TANK BD

- For non-pressurized use
- AISI 304 stainless steel, surface IIIId (2R), marbled outside
- Vaulted tank top, with filling dome 220 mm

- Lid with inner clamp fastener, drilled hole \varnothing 38 mm and removable plastic blank cap to hold the fermentation lock with bung
- Flat tank bottom

Racking outlet

- Up to 240 liter capacity internal thread G 3/4" (BSP) with plastic blank cap
- From 320 liter capacity upwards external thread G 1" (BSP) with plastic blank cap

DIMENSIONS OF FERMENTATION AND STORAGE TANK BD

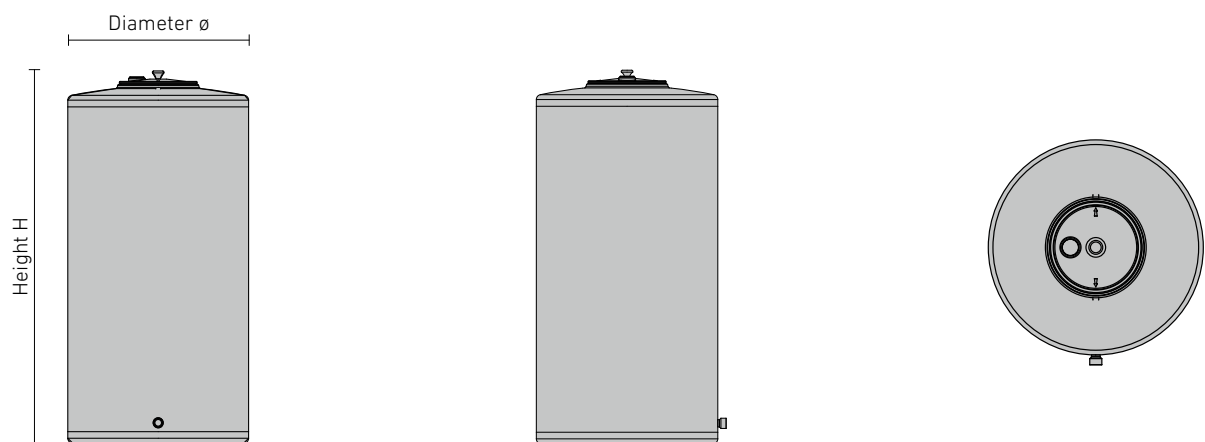

Capacity	\varnothing	H	Order No.
liter	mm	mm	
100	440	758	BD-044 -100
240	550	1,141	BD-055 -240
320	630	1,153	BD-063 -320



Fermentation and storage tank FD

The storage tank FD is entirely made of AISI 304, too. In contrast to storage tank BD, the FD is equipped with welded-on stainless steel legs and an additional bottom outlet.

The FD's bottom and top are both vaulted. This is why it stands on three legs, thus allowing easy operation. The FD is available for capacities up to 625 liter.

APPLICATION RANGE (PRESSURELESS)

- Storage
- Maturation

Ideal for

- Spirits
- Beverages
- Plant construction
- Industry



STANDARD EQUIPMENT FOR FERMENTATION AND STORAGE TANK FD

- For non-pressurized use
- AISI304 stainless steel, surface IIIId (2R), marbled outside
- Vaulted tank top and bottom
- Filling dome in tank top 220 mm
- Lid with inner clamp fastener, drilled hole \varnothing 38 mm and removable plastic blank cap to hold fermentation lock and bung
- Standing on three legs

Racking outlet

- Up to 240 liter capacity internal thread G 3/4" (BSP) with plastic blank cap
- From 330 liter capacity upwards external thread G 1" (BSP) with plastic blank cap

Bottom outlet

- Up to 240 liter capacity bottom outlet neck internal thread G 3/4" (BSP) with plastic blank cap
- From 330 liter capacity upwards bottom outlet neck external thread G 1" (BSP) with plastic blank cap G 1"

DIMENSIONS OF FERMENTATION AND STORAGE TANK FD

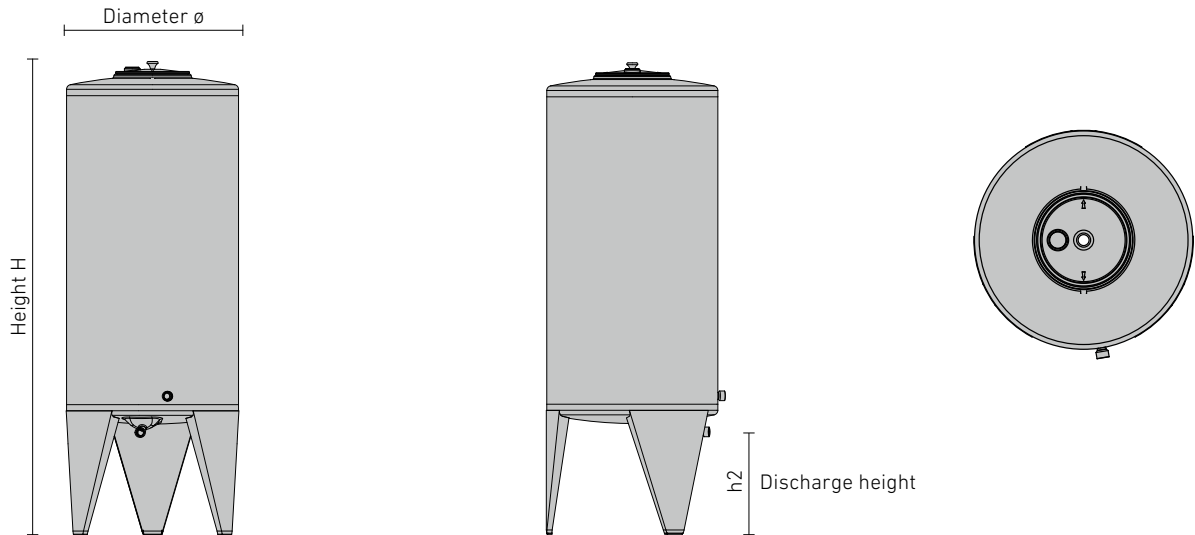

Capacity liter	\varnothing mm	H mm	h2 mm	Order No.
100	440	1,141	325	FD -044 -100
240	550	1,524	325	FD -055 -240
330	630	1,538	315	FD -063 -330
525	820	1,466	305	FD -082 -525
625	820	1,661	305	FD -082 -625



Fermentation and storage tank FD-S

The FD-S is a very stable barrel on three legs, entirely made of stainless steel. Its special 3D inner surface makes cleaning super easy. By default the FD-S comes with a laser welded double jacket.

Thus for example the producers of bottom-fermented beers can directly connect the double jacket to a cooling unit. And of course the FD-S is a perfect fit for any other liquid whose temperature needs to be regulated.

APPLICATION RANGE (PRESSURELESS)

- Fermentation
- Maturation
- Storage

Ideal for

- Beer
- Beverages
- Food
- Plant construction
- Industry



STANDARD EQUIPMENT FOR FERMENTATION AND STORAGE TANK FD-ZKG

- For non-pressurized use
- Tank made of AISI 304 stainless steel, surface IIIId (2R), marbled outside
- Vaulted tank top
- Filling dome on tank top 220 mm LW
- Lid with inner clamp fastener, drill hole \varnothing 38 mm and removable plastic blank bung to hold the fermentation lock and plug
- Stable cone bottom end approx. 60° , not marbled
- Free-standing on welded-on pipe legs with mounting hole

Racking outlet

- For a volume up to 120 liter internal thread G 3/4" with plastic blind plug
- From a volume of 240 liter onward external thread G 1" with plastic-blind cap

Bottom outlet

- For a volume up to 120 liter bottom outlet neck internal thread G 3/4" with plastic blank bung
- From a volume of 240 liter bottom outlet neck external thread G 1" with plastic blank bung

Double jacket

- Laser welded double jacket for cooling with two connecting nozzle G 1" with external thread

Temperature

- Weld-on thread NW 10 DIN 11851 for temperature measuring

DIMENSIONS OF FERMENTATION AND STORAGE TANK FD-S

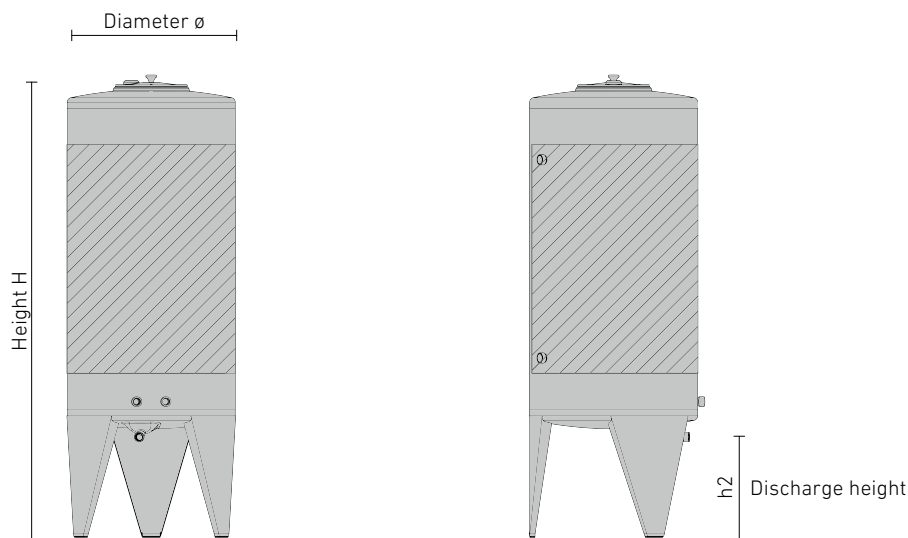

Capacity liter	\varnothing mm	H mm	h2 mm	Order No.
60	440	891	325	FD-044-S-V0019
120	440	1,266	325	FD-044-S-V0020
240	550	1,524	325	FD-055-S-V0047
525	820	1,466	305	FD-082-S-V0067
625	820	1,661	305	FD-082-S-V0068



Fermentation and storage tank FD-ZKG

The cylindric conical fermentation tank FD-ZKG has a cone-shaped funnel mounted underneath its cylindrical shape. This way for instance the yeast can settle down during the fermentation process and can be easily removed afterwards. Even viscous fluids can be drained reliable and completely.

This tank is designed especially for pressureless fermentation and like the other FD tanks is completely made out of stainless steel and equipped with a special 3D inner surface for convenient cleaning. The FD-ZKG comes with a laser welded double jacket by default and thus for example the producers of bottom-fermented beers can directly connect the double jacket to a cooling unit.

APPLICATION RANGE (PRESSURELESS)

- Fermentation
- Maturation
- Storage

Ideal for

- Beer
- Beverages
- Food
- Plant construction
- Industry



STANDARD EQUIPMENT FOR FERMENTATION AND STORAGE TANK FD-ZKG

- For non-pressurized use
- Tank made of AISI 304 stainless steel, surface IIIId (2R), marbled outside
- Vaulted tank top
- Filling dome on tank top 220 mm LW
- Lid with inner clamp fastener, drill hole \varnothing 38 mm and removable plastic blank bung to hold the fermentation lock and plug
- Stable cone bottom end approx. 60° , not marbled, surface IIIId / IIIc
- Free-standing on welded-on pipe legs with mounting hole

Racking outlet

- Up to capacity 120 liter internal thread G 3/4" with plastic blind plug
- From a volume of 240 liter onward external thread G 1" with plastic-blind cap

Bottom outlet

- For a volume with 120 liter bottom outlet neck internal thread G 3/4" with plastic blank bung
- From a volume of 240 liter bottom outlet neck external thread G 1" with plastic blank bung

Sampling

- Weld-on thread NW 10 DIN 11851 (for installation of the sample tap)

Double jacket

- Laser welded double jacket for cooling with two connecting nozzle G 1" with external thread

Temperature

- Weld-on thread NW 10 DIN 11851 for temperature measuring

DIMENSIONS OF FERMENTATION AND STORAGE TANK FD-ZKG

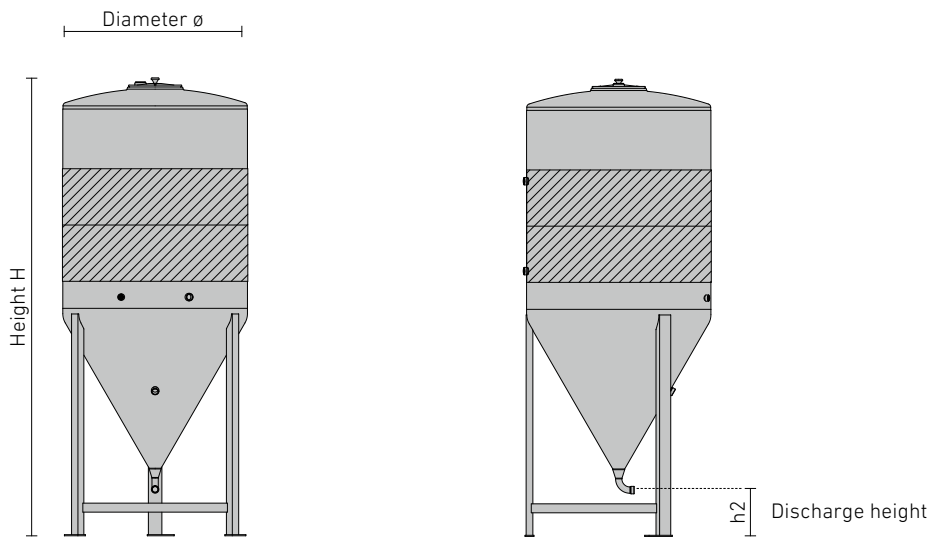

Capacity liter	Capacity hl	\varnothing mm	H mm	h2 mm	Order No.
30	0.30	350	877	200	FD -035 -S -V0002
60	0.60	350	1,150	200	FD -035 -S -V0001
120	1.20	440	1,383	200	FD -044 -S -V0053
240	1.40	550	1,675	200	FD -055 -S -V0030
625	6.25	820	2,044	200	FD -082 -S -V0054

Fermentation and storage tank base tank FS-MO stacking tank AS-MO



APPLICATION RANGE (PRESSURELESS)

- Fermentation
- Maturation
- Storage
- Mixing
- Processes

Ideal for

- Non-alcoholic beverages
- Alcoholic beverages
- Food
- Plant construction
- Industry

The FS-MO base tank is a typical, round, upright standing fermentation and storage tank made of high quality stainless steel. Together with the corresponding stacking tank AS-MO, the FS-MO has been satisfying our clients for decades. Being the all-rounders they are, both tanks can be used for almost all kinds of applications and processes in the production of beverages.

Our tanks live up to their promises: they all have perfect weld seams, an accurately sealing manhole and are all easy to clean. By default the tank top is executed in AISI 316.

If you don't need to stack immediately: no problem! The base tank can be extended with a stacking tank also at a later date. Provided that the maximum total volume per stack is not exceeded, the two tanks can be combined without problems even when they are different sizes (see page 34).





STANDARD EQUIPMENT FOR BASE TANK FS-MO / STACKING TANK AS-MO

- For non-pressurized use
- Tank shell and tank bottom made of AISI 304 stainless steel, surface IIIId (2R), marbled outside
- Tank top made of AISI 316 stainless steel, surface IIIId (2R), marbled outside
- From tank- \varnothing of 1,000 mm upwards with lifting lugs
- Tanks from 2,000 mm tank height upwards and stacking tanks with ladder safety bow
- Vaulted, stable tank top with moulded-on forward up-slope for complete filling and ventilation assuring a very small air contact area
- Moulded connection neck with filling and vent neck external thread NW 50 Rd 78 x 1/6"
- Free-standing base tank on three welded-on legs
- Stacking tank with three welded-on stacking legs

Sampling

- Weld-on thread NW 10 DIN 11851 with sealing cap (for the installation of sampling tap)

Manhole

- Stable manhole neck seamlessly moulded from the tank shell
- Up to 320 liter capacity 320 x 250 mm
- From 525 liter capacity upwards 420 x 320 mm
- Door with butterfly bow and hand wheel

Racking outlet

- Plain surface with drilled hole \varnothing 48 mm to hold weld-on thread NW 40, NW 50 DIN 11851

- Up to 320 liter capacity with stamped on reinforce in tank shell sheet
- From 525 liter capacity upwards with welded-on reinforcing plate











Fill level

- Weld-on thread NW 10 DIN 11851 with sealing cap including fastening points on tank shell (for installation of fill level indicator)

Bottom outlet

- Vaulted, stable tank bottom with integrally moulded forward down-slope for complete draining with moulded connection neck, impeding suction effect with bottom outlet neck
- Up to 820 mm \varnothing NW 40 DIN 11851
- From 1,000 mm \varnothing NW 50 DIN 11851

SET-UP EXAMPLE FOR BASE TANK FS-MO / STACKING TANK AS-MO

Item	Order No.
	<p>Basetank FS-MO-120-1000 liter</p> <ul style="list-style-type: none"> · h1 = approx. 1,267 mm · Standard equipment as on page 31 <p style="text-align: right;">FS-MO-120-1000</p>
	<p>Stacking tank AS-MO-120-2000 liter</p> <ul style="list-style-type: none"> · h5 = 1,916 mm, H = 1,267 mm (h1) + 60 mm (h4) + 1,916 mm (h5) = 3,243 mm, · $H_{\text{compl.}} = 3,243 \text{ mm (H), } 80 \text{ mm (connection)}$ · + approx. 100 mm (height compensation) = approx. 3,423 mm · Standard equipment as on page 31 <p style="text-align: right;">AS-MO-120-2100</p>
	<p>Sampling (page 176)</p> <ul style="list-style-type: none"> · With sampling tap NW 10 DIN 11851 <p style="text-align: right;">64949</p>
	<p>Racking outlet (page 172)</p> <ul style="list-style-type: none"> · Welded gland with thread NW 50 DIN 11851 · With disc valve NW 50 DIN 11851 <p style="text-align: right;">KA-120D 64945</p>
	<p>Fill level (page 177)</p> <ul style="list-style-type: none"> · Mounted fill level indicator NW 10 <p style="text-align: right;">FS-130H</p>
	<p>Bottom outlet (page 172)</p> <ul style="list-style-type: none"> · With butterfly valve NW 50 DIN 11851 <p style="text-align: right;">64945</p>
	<p>Temperature measurement (page 180)</p> <ul style="list-style-type: none"> · Bi-metal dial thermometer \varnothing 100 mm, measuring range -20 °C to +60 °C · Threaded sleeve with locking screw and cap nut NW 10 DIN 11851 <p style="text-align: right;">TM-140C</p>
	<p>Heating and cooling for base tank (page 128)</p> <ul style="list-style-type: none"> · Double jacket A2 1.3 m² with welded gland thread G 1" for connection to available warm water / cold water source · Version 1, Layout 13, connection position A1 <p style="text-align: right;">1A1</p>
	<p>Heating and cooling for stacking tank (page 128)</p> <ul style="list-style-type: none"> · Double jacket A2 1.3 m² with welded gland thread G 1" for connection to available warm water / cold water source · Version 1, Layout 15, connection position A1 <p style="text-align: right;">1A1</p>
	<p>Adjustable feet (page 184)</p> <ul style="list-style-type: none"> · With adjustable feet for tank legs (H = + approx. 100 mm) <p style="text-align: right;">46127</p>

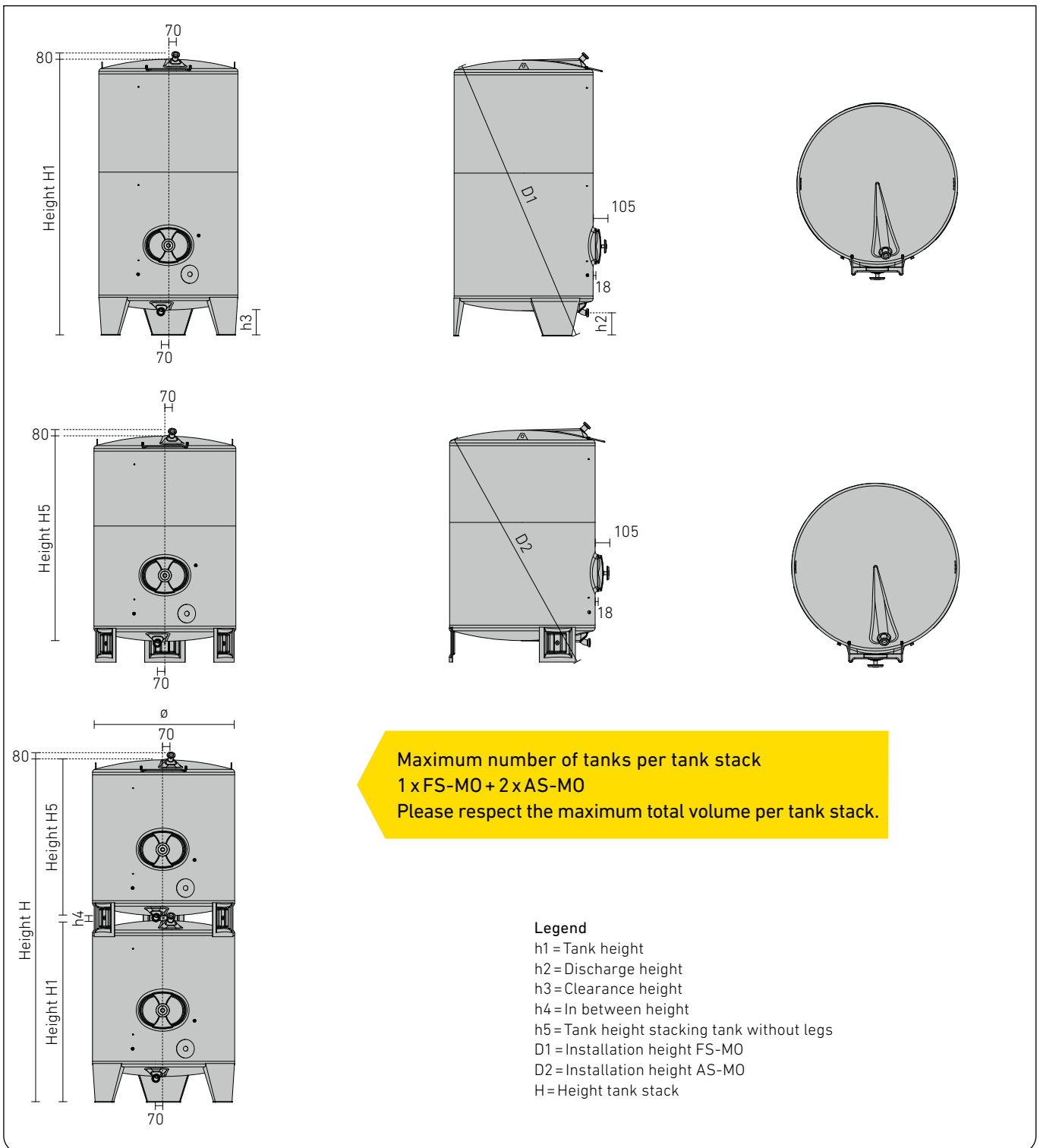
DIMENSIONS BASE TANK FS1-MO, FS-MO / STACKING TANK AS1-MO, AS-MO

Intermediate sizes available

In case of 820 mm \varnothing a 10 mm shell height equates to = 5.30 liter tank volume
 In case of 1,000 mm \varnothing a 10 mm shell height equates to = 7.80 liter tank volume
 In case of 1,200 mm \varnothing a 10 mm shell height equates to = 11.30 liter tank volume
 In case of 1,400 mm \varnothing a 10 mm shell height equates to = 15.30 liter tank volume
 In case of 1,600 mm \varnothing a 10 mm shell height equates to = 20.00 liter tank volume
 In case of 1,800 mm \varnothing a 10 mm shell height equates to = 25.30 liter tank volume
 In case of 2,000 mm \varnothing a 10 mm shell height equates to = 31.20 liter tank volume

Pricing for intermediate sizes

for intermediate sizes the price of the next larger size will apply (plus customization costs)

Option: Tank contact parts made of AISI 316 stainless steel

Surface III d (2R), marbled outside on special request

Brushed outer finish

on special request

BASE TANK FS1-MO, FS-MO / STACKING TANK AS1-MO, AS-MO: TANK Ø 820 MM

Capacity	Ø	h1	h2	h3	h4	h5	D1	D2	H	Order No.	
										Tank 1 FS-MO	Tank 2-3 AS-MO
320	820	914	205	230	84	684	1,075	1,100	*	FS1-MO-082-0320	AS1-MO-082-0320
525	820	1,314	205	230	84	1,089	1,516	1,523	*	FS-MO-082-0525	AS-MO-082-0525
625	820	1,509	205	230	84	1,284	1,693	1,696	*	FS-MO-082-0625	AS-MO-082-0625
750	820	1,772	205	230	84	1,547	1,937	1,940	*	FS-MO-082-0750	AS-MO-082-0750
1,000	820	2,258	205	230	84	-	2,403	-	-	FS-MO-082-1000	-

Tank-Ø 820 mm; maximum total volume per tank stack 1,265 liter

BASE TANK FS-MO / STACKING TANK AS-MO: TANK Ø 1,000 MM

Capacity	Ø	h1	h2	h3	h4	h5	D1	D2	H	Order No.	
										Tank 1 FS-MO	Tank 2-3 AS-MO
650	1,000	1,205	210	239	115	966	1,438	1,460	*	FS-MO-100-0650	AS-MO-100-0650
850	1,000	1,455	210	239	115	1,216	1,645	1,665	*	FS-MO-100-0850	AS-MO-100-0850
1,050	1,000	1,705	210	239	115	1,466	1,863	1,882	*	FS-MO-100-1050	AS-MO-100-1050
1,250	1,000	1,955	210	239	115	1,716	2,088	2,106	*	FS-MO-100-1250	AS-MO-100-1250
1,400	1,000	2,193	210	239	115	-	2,307	-	-	FS-MO-100-1400	-
1,550	1,000	2,318	210	239	115	-	2,424	-	-	FS-MO-100-1550	-
1,800	1,000	2,693	210	239	115	-	2,778	-	-	FS-MO-100-1800	-
2,000	1,000	2,943	210	239	115	-	3,017	-	-	FS-MO-100-2000	-
2,200	1,000	3,193	210	239	115	-	3,257	-	-	FS-MO-100-2200	-
2,350	1,000	3,443	210	239	115	-	3,499	-	-	FS-MO-100-2350	-
2,500	1,000	3,556	210	239	115	-	3,609	-	-	FS-MO-100-2500	-

Tank-Ø 1.000 mm; maximum total volume per tank stack 2,500 liter

BASE TANK FS-MO / STACKING TANK AS-MO: TANK Ø 1,200 MM

Capacity	Ø	h1	h2	h3	h4	h5	D1	D2	H	Order No.	
										Tank 1 FS-MO	Tank 2-3 AS-MO
1,000	1,200	1,267	230	257	60	1,010	1,579	1,546	*	FS-MO-120-1000	AS-MO-120-1000
1,300	1,200	1,517	230	257	60	1,260	1,775	1,739	*	FS-MO-120-1300	AS-MO-120-1300
1,550	1,200	1,767	230	257	60	1,510	1,984	1,946	*	FS-MO-120-1550	AS-MO-120-1550
1,800	1,200	2,017	230	257	60	1,760	2,201	2,162	*	FS-MO-120-1800	AS-MO-120-1800
2,000	1,200	2,173	230	257	60	1,916	2,329	2,300	*	FS-MO-120-2000	AS-MO-120-2000
2,100	1,200	2,255	230	257	60	1,998	2,414	2,375	*	FS-MO-120-2100	AS-MO-120-2100
2,350	1,200	2,505	230	257	60	-	2,642	-	-	FS-MO-120-2350	-
2,500	1,200	2,630	230	257	60	-	2,758	-	-	FS-MO-120-2500	-
2,650	1,200	2,755	230	257	60	-	2,874	-	-	FS-MO-120-2650	-
3,000	1,200	3,087	230	257	60	-	3,186	-	-	FS-MO-120-3000	-
3,200	1,200	3,255	230	257	60	-	3,346	-	-	FS-MO-120-3200	-
3,500	1,200	3,505	230	257	60	-	3,584	-	-	FS-MO-120-3500	-
3,750	1,200	3,743	230	257	60	-	3,813	-	-	FS-MO-120-3750	-
4,000	1,200	3,993	230	257	60	-	4,054	-	-	FS-MO-120-4000	-
4,300	1,200	4,243	230	257	60	-	4,297	-	-	FS-MO-120-4300	-
4,600	1,200	4,493	230	257	60	-	4,540	-	-	FS-MO-120-4600	-

Tank-Ø 1,200 mm; maximum total volume per tank stack 3,400 liter

* The respective height H is calculated as follows: $H = h1 + h4 + h5$

BASE TANK FS-MO / STACKING TANK AS-MO: TANK Ø 1.400 MM

Capacity	Ø	h1	h2	h3	h4	h5	D1	D2	H	Order No.	
										Tank 1 FS-MO	Tank 2-3 AS-MO
1,400	1,400	1,293	240	248	40	1,042	1,711	1,756	*	FS-MO-140-1400	AS-MO-140-1400
1,750	1,400	1,543	240	248	40	1,292	1,894	1,928	*	FS-MO-140-1750	AS-MO-140-1750
2,150	1,400	1,793	240	248	40	1,542	2,092	2,117	*	FS-MO-140-2150	AS-MO-140-2150
2,500	1,400	2,043	240	248	40	1,792	2,300	2,317	*	FS-MO-140-2500	AS-MO-140-2500
2,850	1,400	2,281	240	248	40	2,030	2,505	2,516	*	FS-MO-140-2850	AS-MO-140-2850
3,000	1,400	2,373	240	248	40	2,122	2,586	2,595	*	FS-MO-140-3000	AS-MO-140-3000
3,200	1,400	2,531	240	248	40	-	2,726	-	-	FS-MO-140-3200	-
3,600	1,400	2,781	240	248	40	-	2,952	-	-	FS-MO-140-3600	-
4,000	1,400	3,031	240	248	40	-	3,181	-	-	FS-MO-140-4000	-
4,400	1,400	3,281	240	248	40	-	3,414	-	-	FS-MO-140-4400	-
4,750	1,400	3,531	240	248	40	-	3,648	-	-	FS-MO-140-4750	-
5,100	1,400	3,769	240	248	40	-	3,874	-	-	FS-MO-140-5100	-
5,500	1,400	4,019	240	248	40	-	4,112	-	-	FS-MO-140-5500	-
5,850	1,400	4,269	240	248	40	-	4,351	-	-	FS-MO-140-5850	-
6,300	1,400	4,519	240	248	40	-	4,592	-	-	FS-MO-140-6300	-
6,700	1,400	4,769	240	248	40	-	4,833	-	-	FS-MO-140-6700	-

Tank-Ø 1,400 mm; maximum total volume per tank stack 4,400 liter

BASE TANK FS-MO / STACKING TANK AS-MO: TANK Ø 1.600 MM

Capacity	Ø	h1	h2	h3	h4	h5	D1	D2	H	Order No.	
										Tank 1 FS-MO	Tank 2-3 AS-MO
1,800	1,600	1,347	225	256	70	1,086	1,848	1,840	*	FS-MO -160 -1800	AS-MO-160-1800
2,300	1,600	1,597	225	256	70	1,336	2,023	2,015	*	FS-MO -160 -2300	AS-MO-160-2300
2,800	1,600	1,847	225	256	70	1,586	2,212	2,205	*	FS-MO -160 -2800	AS-MO-160-2800
3,300	1,600	2,097	225	256	70	1,836	2,413	2,406	*	FS-MO -160 -3300	AS-MO-160-3300
3,800	1,600	2,335	225	256	70	2,074	2,612	2,605	*	FS-MO -160 -3800	AS-MO-160-3800
4,200	1,600	2,585	225	256	70	2,324	2,827	2,822	*	FS-MO -160 -4200	AS-MO-160-4200
4,800	1,600	2,835	225	256	70	2,574	3,048	3,043	*	FS-MO -160 -4800	AS-MO-160-4800
5,200	1,600	3,085	225	256	70	-	3,273	-	-	FS-MO -160 -5200	-
5,800	1,600	3,335	225	256	70	-	3,501	-	-	FS-MO -160 -5800	-
6,200	1,600	3,585	225	256	70	-	3,733	-	-	FS-MO -160 -6200	-
6,700	1,600	3,823	225	256	70	-	3,955	-	-	FS-MO -160 -6700	-
7,200	1,600	4,073	225	256	70	-	4,190	-	-	FS-MO -160 -7200	-
7,700	1,600	4,323	225	256	70	-	4,427	-	-	FS-MO -160 -7700	-
8,200	1,600	4,573	225	256	70	-	4,665	-	-	FS-MO -160 -8200	-
8,700	1,600	4,823	225	256	70	-	4,905	-	-	FS-MO -160 -8700	-
9,200	1,600	5,073	225	256	70	-	5,145	-	-	FS-MO -160 -9200	-
9,700	1,600	5,311	225	256	70	-	5,375	-	-	FS-MO -160 -9700	-
10,000	1,600	5,561	225	256	70	-	5,617	-	-	FS-MO -160 -10000	-

Tank-Ø 1,600 mm; maximum total volume per tank stack 10,000 liter

Since the legs of the stacking tank are welded with the top of the base tank only the entire tank stack can be purchased. This way, the size h1 increases by 35 mm and size D1 by 170 mm.

FS-MO without stacking tank: up to 6,200 liter with standard legs

FS-MO WITH stacking tank: up to 6,200 liter with box shaped legs

From 6,700 liter gets all FS-MO boxed shaped legs as standard.

* The respective height H is calculated as follows: $H = h1 + h4 + h5$

BASE TANK FS-MO / STACKING TANK AS-MO: TANK Ø 1,800 MM

Capacity	ø	h1	h2	h3	h4	h5	D1	D2	H	Order No.	
										Tank 1 FS-MO	Tank 2-3 AS-MO
liter	mm	mm	mm	mm	mm	mm	mm	mm	mm		
2,400	1,800	1,369	225	259	70	1,110	2,007	2,006	*	FS-MO-180- 2400	AS -MO -180 -2400
3,000	1,800	1,619	225	259	70	1,360	2,171	2,168	*	FS-MO-180- 3000	AS -MO -180 -3000
3,600	1,800	1,869	225	259	70	1,610	2,350	2,346	*	FS-MO-180- 3600	AS -MO -180 -3600
4,200	1,800	2,119	225	259	70	1,860	2,541	2,536	*	FS-MO-180- 4200	AS -MO -180 -4200
4,800	1,800	2,357	225	259	70	2,098	2,732	2,726	*	FS-MO-180- 4800	AS -MO -180 -4800
5,500	1,800	2,607	225	259	70	2,348	2,940	2,933	*	FS-MO-180- 5500	AS -MO -180 -5500
6,100	1,800	2,857	225	259	70	2,598	3,154	3,147	*	FS-MO-180- 6100	AS -MO -180 -6100
6,700	1,800	3,107	225	259	70	2,848	3,373	3,366	*	FS-MO-180- 6700	AS -MO -180 -6700
7,300	1,800	3,357	225	259	70	3,098	3,596	3,588	*	FS-MO-180- 7300	AS -MO -180 -7300
8,000	1,800	3,607	225	259	70	3,348	3,823	3,815	*	FS-MO-180- 8000	AS -MO -180 -8000
8,500	1,800	3,845	225	259	70	3,586	4,041	4,032	*	FS-MO-180- 8500	AS -MO -180 -8500
9,200	1,800	4,095	225	259	70	3,836	4,272	4,264	*	FS-MO-180- 9200	AS -MO -180 -9200
9,800	1,800	4,345	225	259	70	4,086	4,506	4,497	*	FS-MO-180- 9800	AS -MO -180 -9800
10,400	1,800	4,595	225	259	70	-	4,741	-	-	FS-MO-180-10400	-
11,000	1,800	4,845	225	259	70	-	4,977	-	-	FS-MO-180-11000	-
11,600	1,800	5,095	225	259	70	-	5,215	-	-	FS-MO-180-11600	-
12,200	1,800	5,333	225	259	70	-	5,443	-	-	FS-MO-180-12200	-
12,800	1,800	5,583	225	259	70	-	5,682	-	-	FS-MO-180-12800	-
13,500	1,800	5,833	225	259	70	-	5,923	-	-	FS-MO-180-13500	-
14,000	1,800	6,083	225	259	70	-	6,164	-	-	FS-MO-180-14000	-
14,700	1,800	6,333	225	259	70	-	6,407	-	-	FS-MO-180-14700	-
15,300	1,800	6,583	225	259	70	-	6,649	-	-	FS-MO-180-15300	-

Tank-ø 1,800 mm; maximum total volume per tank stack 12,500 liter

Since the legs of the stacking tank are welded with the top of the base tank only the entire tank stack can be purchased. This way, the size h1 increases by 30 mm and size D1 by 180 mm.

FS-MO without stacking tank: up to 8,000 liter with standard legs

FS-MO WITH stacking tank: up to 8,000 liter with box shaped legs

From 8,500 liter gets all FS-MO boxed shaped legs as standard.

* The respective height H is calculated as follows: $H = h1 + h4 + h5$



BASE TANK FS-MO / STACKING TANK AS-MO: TANK Ø 2,000 MM

Capacity	Ø	h1	h2	h3	h4	h5	D1	D2	H	Order No.	
										Tank 1 FS-MO	Tank 2-3 AS-MO
liter	mm	mm	mm	mm	mm	mm	mm	mm	mm		
3,000	2,000	1,428	225	260	100	1,168	2,148	2,237	*	FS-MO -200 -3000	AS-MO -200 -3000
3,800	2,000	1,678	225	260	100	1,418	2,305	2,393	*	FS-MO -200 -3800	AS-MO -200 -3800
4,600	2,000	1,928	225	260	100	1,668	2,478	2,564	*	FS-MO -200 -4600	AS-MO -200 -4600
5,300	2,000	2,178	225	260	100	1,918	2,663	2,747	*	FS-MO -200 -5300	AS-MO -200 -5300
6,100	2,000	2,416	225	260	100	2,156	2,849	2,931	*	FS-MO -200 -6100	AS-MO -200 -6100
6,800	2,000	2,666	225	260	100	2,406	3,052	3,132	*	FS-MO -200 -6800	AS-MO -200 -6800
7,600	2,000	2,916	225	260	100	2,656	3,261	3,340	*	FS-MO -200 -7600	AS-MO -200 -7600
8,400	2,000	3,166	225	260	100	2,906	3,476	3,553	*	FS-MO -200 -8400	AS-MO -200 -8400
9,200	2,000	3,416	225	260	100	3,156	3,695	3,771	*	FS-MO -200 -9200	AS-MO -200 -9200
10,000	2,000	3,666	225	260	100	3,406	3,918	3,992	*	FS-MO -200 -10000	AS-MO -200 -10000
10,600	2,000	3,904	225	260	100	-	4,133	-	-	FS-MO -200 -10600	-
11,400	2,000	4,154	225	260	100	-	4,362	-	-	FS-MO -200 -11400	-
12,200	2,000	4,404	225	260	100	-	4,592	-	-	FS-MO -200 -12200	-
13,000	2,000	4,654	225	260	100	-	4,825	-	-	FS-MO -200 -13000	-
13,700	2,000	4,904	225	260	100	-	5,059	-	-	FS-MO -200 -13700	-
14,500	2,000	5,154	225	260	100	-	5,295	-	-	FS-MO -200 -14500	-
15,200	2,000	5,392	225	260	100	-	5,521	-	-	FS-MO -200 -15200	-
16,000	2,000	5,642	225	260	100	-	5,759	-	-	FS-MO -200 -16000	-
16,800	2,000	5,892	225	260	100	-	5,998	-	-	FS-MO -200 -16800	-
17,500	2,000	6,142	225	260	100	-	6,238	-	-	FS-MO -200 -17500	-
18,300	2,000	6,392	225	260	100	-	6,479	-	-	FS-MO -200 -18300	-
19,000	2,000	6,642	225	260	100	-	6,720	-	-	FS-MO -200 -19000	-
20,000	2,000	6,880	225	260	100	-	6,950	-	-	FS-MO -200 -20000	-

Tank-Ø 2,000 mm; maximum total volume per tank stack 16,300 liter

Since the legs of the stacking tank are welded with the top of the base tank only the entire tank stack can be purchased. This way, the size h1 increases by 60mm and size D1 by 220mm.

FS-MO without stacking tank: up to 10,000 liter with standard legs

FS-MO WITH stacking tank: up to 10,000 liter with box shaped legs

From 10,600 liter gets all FS-MO boxed shaped legs as standard.

* The respective height H is calculated as follows: $H = h1 + h4 + h5$



Fermentation and storage tank FS-M0



When it comes to larger tanks over 2,000 mm diameter the renowned Speidel quality is all that counts. And this is not only true for the production of tanks, but also for the planning, development and installation of large facilities.

Beverage companies appreciate our elaborate project planning and its smooth realization. We are responsive to our customers' individual needs also when it comes to larger installations. And also after the installation we are always ready to listen to you.

APPLICATION RANGE (PRESSURELESS)

- Storage
- Maturation
- Fermentation
- Mixing
- Processes

Ideal for

- Non-alcoholic beverages
- Alcoholic beverages
- Food
- Plant construction
- Industry





STANDARD EQUIPMENT FOR FERMENTATION AND STORAGE TANK FS-MO

- For non-pressurized use
- Tank shell and tank bottom made of AISI 304 stainless steel, surface IIIId (2R) / IIIc (2B)
- Tank top made of AISI 316 stainless steel, surface IIIId (2R) / IIIc (2B)
- Tank shell and legs marbled outside
- With lifting lugs and ladder safety bow
- Vaulted, stable tank top, with filling and vent neck located in top centre, external thread NW 50 Rd 78 x 1/6"
- Free-standing on welded-on box-shaped legs – perfect stability and force transmission into the tank shell

Sampling

- Weld-on thread NW 10 DIN 11851 with sealing cap (for the installation of sampling tap)

Manhole up to Ø 3,000 mm

- Stable manhole neck seamlessly moulded from the tank shell 420 x 320 mm, door with butterfly bow and hand wheel

Manhole from Ø 3,200 mm upwards

- Welded stable manhole neck 340 x 440 mm, door with swivelling handle and toggle nut

Racking outlet

- Reinforcing plate with drilled hole Ø 48 mm to hold weld-on thread NW 40, NW 50 DIN 11851











Fill level

- Weld-on thread NW 10 DIN 11851 with sealing cap on tank including fastening points on tank shell (for the installation of fill level indicator)

Bottom outlet

- Vaulted, stable tank bottom, in bottom centre with forward drawn discharge pipe and outlet with thread NW 50 DIN 11851

SET-UP EXAMPLE FOR FERMENTATION AND STORAGE TANK FS-MO

Item	Order No.
	<p>Base tank FS-MO-240-20000 liter</p> <ul style="list-style-type: none"> · h1 = 5,270 mm, · $H_{\text{compl.}} = 5,270 \text{ mm (h1)} + 320 \text{ mm (dome)} + 150 \text{ mm (cleaning pipe)}$ · + approx. 100 mm (height compensation) = 5,840 mm · Standard equipment as on page 59 <p style="text-align: right;">FS-MO-240-20000</p>
	<p>Ventilation / Filling (page 168)</p> <ul style="list-style-type: none"> · Filler neck NW 400 in tank top, positioned in upright, forward direction (with welded-on bead), H = + 320 mm · Flap lid with filler neck NW 50 external thread Rd 78 x 1/6" <p style="text-align: right;">OB-040T</p>
	<p>Cleaning (page 186)</p> <ul style="list-style-type: none"> · 360° cleaning spray head perforation with clip fastener including cleaning pipe with thread NW 40 DIN 11851, H = + 150 mm · Spray head NW 40 detachable from outside · Disc valve NW 40 DIN 11851 <p style="text-align: right;">RL-040C RL-041A 61375</p>
	<p>Sampling (page 176)</p> <ul style="list-style-type: none"> · With sampling tap NW 10 DIN 11851 <p style="text-align: right;">64949</p>
	<p>Racking outlet (page 172)</p> <ul style="list-style-type: none"> · Welded gland with thread NW 50 DIN 11851 · With disc valve NW 50 DIN 11851 <p style="text-align: right;">KA-120D 64945</p>
	<p>Fill level (page 177)</p> <ul style="list-style-type: none"> · Fill level indicator NW 10 mounted <p style="text-align: right;">FS-130K</p>
	<p>Bottom outlet (page 172)</p> <ul style="list-style-type: none"> · With disc valve NW 50 DIN 11851 <p style="text-align: right;">64945</p>
	<p>Temperature measurement (page 180)</p> <ul style="list-style-type: none"> · Bi-metal dial thermometer ø 100 mm, measuring range - 20 °C to + 60 °C · Threaded sleeve with locking screw and cap nut NW 10 DIN 11851 <p style="text-align: right;">TM-140C</p>
	<p>Heating and cooling jacket (page 128)</p> <ul style="list-style-type: none"> · Double jacket B7 12.9 m² with welded gland thread G 1" for connection to available warm water / cold water source · Version 1, layout 35, connection position B7 <p style="text-align: right;">1B7</p>
	<p>Stirring device (page 190)</p> <ul style="list-style-type: none"> · Stirring device flange mounted on the side of the tank shell DN 200 · Stirring device for mixing <p style="text-align: right;">FL-200A</p>
	<p>Adjustable feet (page 184)</p> <ul style="list-style-type: none"> · With height compensation for tank legs (H = + approx. 100 mm) <p style="text-align: right;">46129</p>

DIMENSIONS OF FERMENTATION AND STORAGE TANK FS-MO

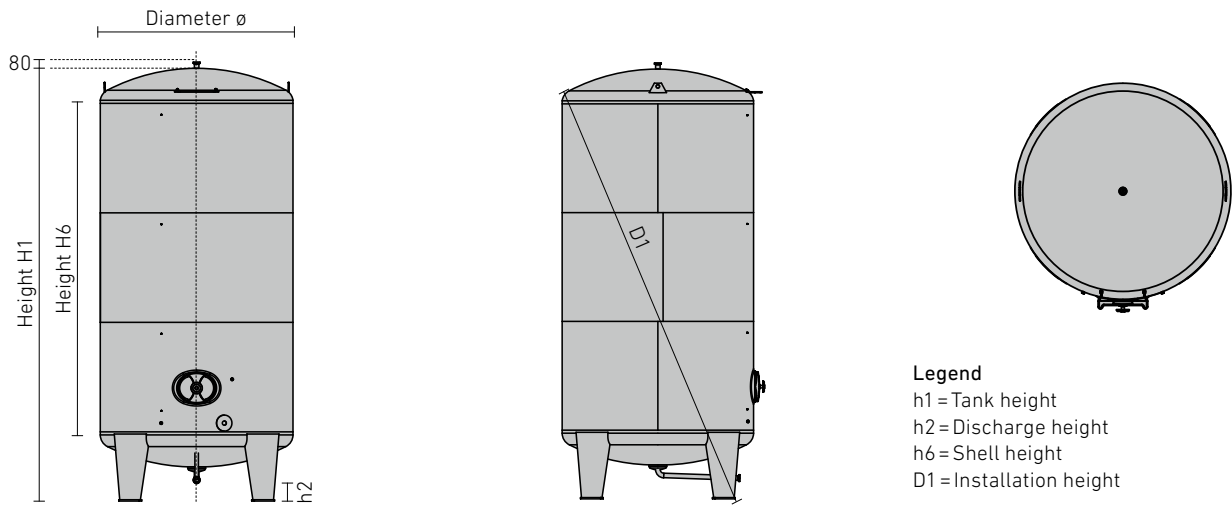

FERMENTATION AND STORAGE TANK FS-MO: TANK Ø 2,200 MM

Capacity liter	ø mm	h1 mm	h2 mm	h6 mm	D1 mm	HV	Order No.
7,400	2,200	2,690	225	1,500	3,130	8 x M24	FS-MO-220- 7400
8,400	2,200	2,940	225	1,750	3,330	8 x M24	FS-MO-220- 8400
9,200	2,200	3,190	225	2,000	3,536	8 x M24	FS-MO-220- 9200
10,200	2,200	3,440	225	2,250	3,750	8 x M24	FS-MO-220-10200
11,000	2,200	3,690	225	2,500	3,965	8 x M24	FS-MO-220-11000
12,000	2,200	3,940	225	2,750	4,185	8 x M24	FS-MO-220-12000
13,000	2,200	4,190	225	3,000	4,410	8 x M24	FS-MO-220-13000
14,000	2,200	4,440	225	3,250	4,640	8 x M24	FS-MO-220-14000
15,000	2,200	4,690	225	3,500	4,875	8 x M24	FS-MO-220-15000
16,000	2,200	4,940	225	3,750	5,110	8 x M24	FS-MO-220-16000
16,800	2,200	5,190	225	4,000	5,350	8 x M24	FS-MO-220-16800
17,500	2,200	5,440	225	4,250	5,590	8 x M24	FS-MO-220-17500
18,500	2,200	5,690	225	4,500	5,830	8 x M24	FS-MO-220-18500
19,500	2,200	5,940	225	4,750	6,075	8 x M24	FS-MO-220-19500
20,500	2,200	6,190	225	5,000	6,320	8 x M24	FS-MO-220-20500
21,500	2,200	6,440	225	5,250	6,560	8 x M24	FS-MO-220-21500
22,500	2,200	6,690	225	5,500	6,810	8 x M24	FS-MO-220-22500
23,500	2,200	6,940	225	5,750	7,055	8 x M24	FS-MO-220-23500
24,500	2,200	7,190	225	6,000	7,300	8 x M24	FS-MO-220-24500
25,000	2,200	7,440	225	6,250	7,545	8 x M24	FS-MO-220-25000

FERMENTATION AND STORAGE TANK FS-MO: TANK Ø 2,400 MM

Capacity liter	Ø mm	h1 mm	h2 mm	h6 mm	D1 mm	HV	Order No.
8,900	2,400	2,770	225	1,500	3,285	8xM24	FS-MO-240 -8900
10,000	2,400	3,020	225	1,750	3,480	8xM24	FS-MO-240 -10000
11,200	2,400	3,270	225	2,000	3,680	8xM24	FS-MO-240 -11200
12,300	2,400	3,520	225	2,250	3,890	8xM24	FS-MO-240 -12300
13,500	2,400	3,770	225	2,500	4,100	8xM24	FS-MO-240 -13500
14,500	2,400	4,020	225	2,750	4,320	8xM24	FS-MO-240 -14500
15,500	2,400	4,270	225	3,000	4,540	8xM24	FS-MO-240 -15500
16,500	2,400	4,520	225	3,250	4,765	8xM24	FS-MO-240 -16500
18,000	2,400	4,770	225	3,500	4,990	8xM24	FS-MO-240 -18000
19,000	2,400	5,020	225	3,750	5,225	8xM24	FS-MO-240 -19000
20,000	2,400	5,270	225	4,000	5,460	8xM24	FS-MO-240 -20000
21,000	2,400	5,520	225	4,250	5,700	8xM24	FS-MO-240 -21000
22,500	2,400	5,770	225	4,500	5,940	8xM24	FS-MO-240 -22500
23,500	2,400	6,020	225	4,750	6,180	8xM24	FS-MO-240 -23500
24,500	2,400	6,270	225	5,000	6,420	8xM24	FS-MO-240 -24500
25,500	2,400	6,520	225	5,250	6,665	8xM30	FS-MO-240 -25500
27,000	2,400	6,770	225	5,500	6,905	8xM30	FS-MO-240 -27000
28,000	2,400	7,020	225	5,750	7,150	8xM30	FS-MO-240 -28000
29,000	2,400	7,270	225	6,000	7,395	8xM30	FS-MO-240 -29000
30,000	2,400	7,520	225	6,250	7,640	8xM30	FS-MO-240 -30000

FERMENTATION AND STORAGE TANK FS-MO: TANK Ø 2,600 MM

Capacity liter	Ø mm	h1 mm	h2 mm	h6 mm	D1 mm	HV	Order No.
10,800	2,600	2,860	225	1,500	3,480	8xM24	FS-MO-260 -10800
12,200	2,600	3,110	225	1,750	3,670	8xM24	FS-MO-260 -12200
13,500	2,600	3,360	225	2,000	3,865	8xM24	FS-MO-260 -13500
14,500	2,600	3,610	225	2,250	4,070	8xM24	FS-MO-260 -14500
16,000	2,600	3,860	225	2,500	4,280	8xM24	FS-MO-260 -16000
17,300	2,600	4,110	225	2,750	4,490	8xM24	FS-MO-260 -17300
18,500	2,600	4,360	225	3,000	4,710	8xM24	FS-MO-260 -18500
20,000	2,600	4,610	225	3,250	4,930	8xM24	FS-MO-260 -20000
21,300	2,600	4,860	225	3,500	5,150	8xM24	FS-MO-260 -21300
22,500	2,600	5,110	225	3,750	5,375	8xM24	FS-MO-260 -22500
24,000	2,600	5,360	225	4,000	5,610	8xM24	FS-MO-260 -24000
25,300	2,600	5,610	225	4,250	5,845	8xM30	FS-MO-260 -25300
26,500	2,600	5,860	225	4,500	6,080	8xM30	FS-MO-260 -26500
28,000	2,600	6,110	225	4,750	6,320	8xM30	FS-MO-260 -28000
29,000	2,600	6,360	225	5,000	6,560	8xM30	FS-MO-260 -29000
30,500	2,600	6,610	225	5,250	6,800	8xM30	FS-MO-260 -30500
32,000	2,600	6,860	225	5,500	7,040	8xM30	FS-MO-260 -32000
33,000	2,600	7,110	225	5,750	7,290	8xM30	FS-MO-260 -33000
34,500	2,600	7,360	225	6,000	7,530	8xM30	FS-MO-260 -34500
35,800	2,600	7,610	225	6,250	7,775	10xM30	FS-MO-260 -35800
37,000	2,600	7,860	225	6,500	8,020	10xM30	FS-MO-260 -37000
38,500	2,600	8,110	225	6,750	8,265	10xM30	FS-MO-260 -38500
39,800	2,600	8,360	225	7,000	8,510	10xM30	FS-MO-260 -39800

FERMENTATION AND STORAGE TANK FS-MO: TANK Ø 2,800 MM

Capacity	Ø	h1	h2	h6	D1	HV	Order No.
liter	mm	mm	mm	mm	mm		
12,500	2,800	2,890	225	1,500	3,630	8xM24	FS -MO -280 -12500
14,000	2,800	3,140	225	1,750	3,815	8xM24	FS -MO -280 -14000
15,500	2,800	3,390	225	2,000	4,005	8xM24	FS -MO -280 -15500
17,000	2,800	3,640	225	2,250	4,205	8xM24	FS -MO -280 -17000
18,500	2,800	3,890	225	2,500	4,405	8xM24	FS -MO -280 -18500
20,000	2,800	4,140	225	2,750	4,615	8xM24	FS -MO -280 -20000
21,500	2,800	4,390	225	3,000	4,830	8xM24	FS -MO -280 -21500
23,000	2,800	4,640	225	3,250	5,045	8xM24	FS -MO -280 -23000
24,500	2,800	4,890	225	3,500	5,265	8xM24	FS -MO -280 -24500
26,000	2,800	5,140	225	3,750	5,485	8xM30	FS -MO -280 -26000
27,500	2,800	5,390	225	4,000	5,710	8xM30	FS -MO -280 -27500
29,400	2,800	5,640	225	4,250	5,940	8xM30	FS -MO -280 -29400
31,000	2,800	5,890	225	4,500	6,170	8xM30	FS -MO -280 -31000
32,500	2,800	6,140	225	4,750	6,400	8xM30	FS -MO -280 -32500
34,000	2,800	6,390	225	5,000	6,635	8xM30	FS -MO -280 -34000
35,500	2,800	6,640	225	5,250	6,870	8xM30	FS -MO -280 -35500
37,000	2,800	6,890	225	5,500	7,110	8xM30	FS -MO -280 -37000
38,500	2,800	7,140	225	5,750	7,350	10xM30	FS -MO -280 -38500
40,000	2,800	7,390	225	6,000	7,620	10xM30	FS -MO -280 -40000
41,500	2,800	7,640	225	6,250	7,860	10xM30	FS -MO -280 -41500
43,000	2,800	7,890	225	6,500	8,100	10xM30	FS -MO -280 -43000
44,500	2,800	8,140	225	6,750	8,345	10xM30	FS -MO -280 -44500

FERMENTATION AND STORAGE TANK FS-MO: TANK Ø 3,000 MM

Capacity liter	Ø mm	h1 mm	h2 mm	h6 mm	D1 mm	HV	Order No.
16,000	3,000	3,130	225	1,500	3,855	8xM30	FS-MO-300- 16000
17,500	3,000	3,380	225	1,750	4,040	8xM30	FS-MO-300- 17500
19,500	3,000	3,630	225	2,000	4,230	8xM30	FS-MO-300- 19500
21,000	3,000	3,880	225	2,250	4,430	8xM30	FS-MO-300- 21000
23,000	3,000	4,130	225	2,500	4,630	8xM30	FS-MO-300- 23000
24,500	3,000	4,380	225	2,750	4,840	8xM30	FS-MO-300- 24500
26,500	3,000	4,630	225	3,000	5,050	8xM30	FS-MO-300- 26500
28,000	3,000	4,880	225	3,250	5,270	8xM30	FS-MO-300- 28000
30,000	3,000	5,130	225	3,500	5,490	8xM30	FS-MO-300- 30000
31,500	3,000	5,380	225	3,750	5,710	8xM30	FS-MO-300- 31500
33,500	3,000	5,630	225	4,000	5,935	8xM30	FS-MO-300- 33500
35,000	3,000	5,880	225	4,250	6,160	8xM30	FS-MO-300- 35000
37,000	3,000	6,130	225	4,500	6,390	8xM30	FS-MO-300- 37000
38,500	3,000	6,380	225	4,750	6,625	10xM30	FS-MO-300- 38500
40,500	3,000	6,630	225	5,000	6,860	10xM30	FS-MO-300- 40500
42,000	3,000	6,880	225	5,250	7,095	10xM30	FS-MO-300- 42000
44,000	3,000	7,130	225	5,500	7,335	10xM30	FS-MO-300- 44000
45,500	3,000	7,380	225	5,750	7,575	10xM30	FS-MO-300- 45500
47,500	3,000	7,630	225	6,000	7,815	12xM30	FS-MO-300- 47500
49,000	3,000	7,880	225	6,250	8,060	12xM30	FS-MO-300- 49000
51,000	3,000	8,130	225	6,500	8,310	12xM30	FS-MO-300- 51000
53,000	3,000	8,380	225	6,750	8,560	12xM30	FS-MO-300- 53000
54,500	3,000	8,630	225	7,000	8,810	12xM30	FS-MO-300- 54500
56,500	3,000	8,880	225	7,250	9,060	12xM30	FS-MO-300- 56500
58,000	3,000	9,130	225	7,500	9,310	12xM30	FS-MO-300- 58000



FERMENTATION AND STORAGE TANK FS-MO: TANK Ø 3,200 MM

Capacity liter	Ø mm	h1 mm	h2 mm	h6 mm	D1 mm	HV	Order No.
18,800	3,200	3,230	225	1,500	4,050	8 x M30	FS-MO-320- 18800
20,500	3,200	3,480	225	1,750	4,235	8 x M30	FS-MO-320- 20500
22,500	3,200	3,730	225	2,000	4,425	8 x M30	FS-MO-320- 22500
24,500	3,200	3,980	225	2,250	4,620	8 x M30	FS-MO-320- 24500
26,500	3,200	4,230	225	2,500	4,820	8 x M30	FS-MO-320- 26500
28,500	3,200	4,480	225	2,750	5,025	8 x M30	FS-MO-320- 28500
30,500	3,200	4,730	225	3,000	5,235	8 x M30	FS-MO-320- 30500
32,500	3,200	4,980	225	3,250	5,445	8 x M30	FS-MO-320- 32500
34,500	3,200	5,230	225	3,500	5,725	8 x M30	FS-MO-320- 34500
36,500	3,200	5,480	225	3,750	5,940	8 x M30	FS-MO-320- 36500
38,500	3,200	5,730	225	4,000	6,160	10 x M30	FS-MO-320- 38500
40,500	3,200	5,980	225	4,250	6,385	10 x M30	FS-MO-320- 40500
42,500	3,200	6,230	225	4,500	6,605	10 x M30	FS-MO-320- 42500
44,500	3,200	6,480	225	4,750	6,835	10 x M30	FS-MO-320- 44500
46,500	3,200	6,730	225	5,000	7,060	10 x M30	FS-MO-320- 46500
48,500	3,200	6,980	225	5,250	7,295	10 x M30	FS-MO-320- 48500
50,500	3,200	7,230	225	5,500	7,555	12 x M36	FS-MO-320- 50500
52,500	3,200	7,480	225	5,750	7,790	12 x M36	FS-MO-320- 52500
54,500	3,200	7,730	225	6,000	8,025	12 x M36	FS-MO-320- 54500
56,500	3,200	7,980	225	6,250	8,265	12 x M36	FS-MO-320- 56500
58,500	3,200	8,230	225	6,500	8,500	12 x M36	FS-MO-320- 58500
60,500	3,200	8,480	225	6,750	8,740	12 x M36	FS-MO-320- 60500
62,500	3,200	8,730	225	7,000	8,985	12 x M36	FS-MO-320- 62500
64,000	3,200	8,980	225	7,250	9,225	12 x M36	FS-MO-320- 64000
66,500	3,200	9,230	225	7,500	9,465	12 x M36	FS-MO-320- 66500
68,500	3,200	9,480	225	7,750	9,710	12 x M36	FS-MO-320- 68500



FERMENTATION AND STORAGE TANK FS-MO: TANK Ø 3,400 MM

Capacity liter	Ø mm	h1 mm	h2 mm	h6 mm	D1 mm	HV	Order No.
21,500	3,400	3,260	225	1,500	4,285	10 x M30	FS-MO-340-21500
24,000	3,400	3,510	225	1,750	4,455	10 x M30	FS-MO-340-24000
26,000	3,400	3,760	225	2,000	4,635	10 x M30	FS-MO-340-26000
28,000	3,400	4,010	225	2,250	4,820	10 x M30	FS-MO-340-28000
30,500	3,400	4,260	225	2,500	5,010	10 x M30	FS-MO-340-30500
33,000	3,400	4,510	225	2,750	5,210	10 x M30	FS-MO-340-33000
35,000	3,400	4,760	225	3,000	5,410	10 x M30	FS-MO-340-35000
37,500	3,400	5,010	225	3,250	5,615	10 x M30	FS-MO-340-37500
39,500	3,400	5,260	225	3,500	5,825	10 x M30	FS-MO-340-39500
42,000	3,400	5,510	225	3,750	6,040	10 x M30	FS-MO-340-42000
44,000	3,400	5,760	225	4,000	6,255	10 x M30	FS-MO-340-44000
46,500	3,400	6,010	225	4,250	6,475	10 x M30	FS-MO-340-46500
48,500	3,400	6,260	225	4,500	6,695	10 x M30	FS-MO-340-48500
51,000	3,400	6,510	225	4,750	6,950	12 x M36	FS-MO-340-51000
53,000	3,400	6,760	225	5,000	7,170	12 x M36	FS-MO-340-53000
55,500	3,400	7,010	225	5,250	7,395	12 x M36	FS-MO-340-55500
57,500	3,400	7,260	225	5,500	7,625	12 x M36	FS-MO-340-57500
60,000	3,400	7,510	225	5,750	7,850	12 x M36	FS-MO-340-60000
62,000	3,400	7,760	225	6,000	8,095	12 x M36	FS-MO-340-62000
64,500	3,400	8,010	225	6,250	8,330	12 x M36	FS-MO-340-64500
66,500	3,400	8,260	225	6,500	8,565	12 x M36	FS-MO-340-66500
69,000	3,400	8,510	225	6,750	8,800	12 x M36	FS-MO-340-69000
71,000	3,400	8,760	225	7,000	9,050	12 x M36	FS-MO-340-71000
73,000	3,400	9,010	225	7,250	9,295	12 x M36	FS-MO-340-73000
75,500	3,400	9,260	225	7,500	9,530	12 x M36	FS-MO-340-75500
78,000	3,400	9,510	225	7,750	9,775	12 x M36	FS-MO-340-78000
80,000	3,400	9,760	225	8,000	10,015	14 x M36	FS-MO-340-80000
82,000	3,400	10,010	225	8,250	10,260	14 x M36	FS-MO-340-82000
84,500	3,400	10,260	225	8,500	10,500	14 x M36	FS-MO-340-84500
87,000	3,400	10,510	225	8,750	10,745	14 x M36	FS-MO-340-87000
89,000	3,400	10,760	225	9,000	10,990	14 x M36	FS-MO-340-89000



FERMENTATION AND STORAGE TANK FS-MO: TANK Ø 3,600 MM

Capacity liter	Ø mm	h1 mm	h2 mm	h6 mm	D1 mm	HV	Order No.
24,500	3,600	3,340	225	1,500	4,415	10 x M30	FS-MO-360- 24500
27,000	3,600	3,590	225	1,750	4,580	10 x M30	FS-MO-360- 27000
29,500	3,600	3,840	225	2,000	4,755	10 x M30	FS-MO-360- 29500
32,000	3,600	4,090	225	2,250	4,940	10 x M30	FS-MO-360- 32000
35,000	3,600	4,340	225	2,500	5,125	10 x M30	FS-MO-360- 35000
37,500	3,600	4,590	225	2,750	5,320	10 x M30	FS-MO-360- 37500
40,000	3,600	4,840	225	3,000	5,520	10 x M30	FS-MO-360- 40000
42,500	3,600	5,090	225	3,250	5,720	10 x M30	FS-MO-360- 42500
45,000	3,600	5,340	225	3,500	5,925	10 x M30	FS-MO-360- 45000
47,500	3,600	5,590	225	3,750	6,140	10 x M30	FS-MO-360- 47500
50,000	3,600	5,840	225	4,000	6,430	10 x M30	FS-MO-360- 50000
52,500	3,600	6,090	225	4,250	6,645	10 x M36	FS-MO-360- 52500
55,000	3,600	6,340	225	4,500	6,860	12 x M36	FS-MO-360- 55000
57,500	3,600	6,590	225	4,750	7,080	12 x M36	FS-MO-360- 57500
60,000	3,600	6,840	225	5,000	7,305	12 x M36	FS-MO-360- 60000
62,500	3,600	7,090	225	5,250	7,530	12 x M36	FS-MO-360- 62500
65,000	3,600	7,340	225	5,500	7,755	12 x M36	FS-MO-360- 65000
67,500	3,600	7,590	225	5,750	7,985	12 x M36	FS-MO-360- 67500
70,000	3,600	7,840	225	6,000	8,230	12 x M36	FS-MO-360- 70000
72,500	3,600	8,090	225	6,250	8,460	12 x M36	FS-MO-360- 72500
75,000	3,600	8,340	225	6,500	8,695	12 x M36	FS-MO-360- 75000
78,000	3,600	8,590	225	6,750	8,930	12 x M36	FS-MO-360- 78000
80,000	3,600	8,840	225	7,000	9,170	14 x M36	FS-MO-360- 80000
83,000	3,600	9,090	225	7,250	9,405	14 x M36	FS-MO-360- 83000
85,500	3,600	9,340	225	7,500	9,645	14 x M36	FS-MO-360- 85500
88,000	3,600	9,590	225	7,750	9,885	14 x M36	FS-MO-360- 88000
90,000	3,600	9,840	225	8,000	10,130	14 x M36	FS-MO-360- 90000
93,000	3,600	10,090	225	8,250	10,370	14 x M36	FS-MO-360- 93000
95,500	3,600	10,340	225	8,500	10,615	16 x M36	FS-MO-360- 95500
98,000	3,600	10,590	225	8,750	10,855	16 x M36	FS-MO-360- 98000
100,500	3,600	10,840	225	9,000	11,100	16 x M36	FS-MO-360-100500
103,000	3,600	11,110	225	9,250	11,370	16 x M36	FS-MO-360-103000
105,500	3,600	11,360	225	9,500	11,620	16 x M36	FS-MO-360-105500
108,000	3,600	11,610	225	9,750	11,870	16 x M36	FS-MO-360-108000
110,500	3,600	11,860	225	10,000	12,120	16 x M36	FS-MO-360-110500
113,000	3,600	12,110	225	10,250	12,370	16 x M36	FS-MO-360-113000
115,500	3,600	12,360	225	10,500	12,620	18 x M36	FS-MO-360-115500
118,000	3,600	12,610	225	10,750	12,870	18 x M36	FS-MO-360-118000
120,500	3,600	12,860	225	11,000	13,120	18 x M36	FS-MO-360-120500
123,000	3,600	13,110	225	11,250	13,370	18 x M36	FS-MO-360-123000
126,000	3,600	13,360	225	11,500	13,620	18 x M36	FS-MO-360-126000

Stacking tanks – sizes and prices on request

Additional diameters Ø 1.900 mm, Ø 2.100 mm, Ø 2.300 mm, Ø 2.500 mm,
Ø 3.500 mm, Ø 3.800 mm, Ø 4.000 mm on request

Intermediate sizes available

In case of 2,200 mm Ø a 10 mm shell height equates to= 038.00 liter tank volume
 In case of 2,400mm Ø a 10 mm shell height equates to= 445.10 liter tank volume
 In case of 2,600 mm Ø a 10 mm shell height equates to= 053.00 liter tank volume
 In case of 2,800 mm Ø a 10 mm shell height equates to= 061.50 liter tank volume
 In case of 3,000 mm Ø a 10 mm shell height equates to= 070.70 liter tank volume
 In case of 3,200 mm Ø a 10 mm shell height equates to= 080.70 liter tank volume
 In case of 3,400 mm Ø a 10 mm shell height equates to= 090.50 liter tank volume
 In case of 3,600 mm Ø a 10 mm shell height equates to= 101.50 liter tank volume

Pricing for intermediate sizes

for intermediate sizes the price of the next larger size will apply (plus customization costs)

Option: Tank contact parts

made of AISI 316 stainless steel
 Surface IIId (2R), marbled outside
 on special request

Brushed outer finish

on special request

Fermentation and storage tanks

Rectangular base tank RS-M0

Rectangular stacking tank RA-M0



If the room you have is restricted, Speidel's cubical tanks are just the right thing for you! They fit perfectly, have perfect weld seams and their curves are easy to clean. Our serial production is more hygienic and cheaper than a customised version.

Therefore, we rather recommend our space-saving models. They guarantee you best Speidel quality, perfect fit, optimal hygiene and easy cleaning.

APPLICATION RANGE (PRESSURELESS)

- Storage
- Maturation
- Fermentation
- Mixing
- Processes

Ideal for

- Non-alcoholic beverages
- Alcoholic beverages
- Food
- Plant construction
- Industry

Perfect utilisation of space
for small, narrow cellars.





STANDARD EQUIPMENT FOR RECTANGULAR BASE TANK RS-MO / STACKING TANK RA-MO

- For non-pressurized use
- Tank shell and tank bottom made of AISI 304 stainless steel, surface IIIId (2R), marbled outside
- Tank top made of AISI 316 stainless steel, surface IIIId (2R), marbled outside
- With lifting lugs
- Base tank from 2,000 mm tank height upwards and stacking tank with ladder safety bow
- Vaulted, stable tank top with moulded-on forward up-slope for complete filling and ventilation assuring a very small air contact area
- Moulded connection neck with filling and vent neck, external thread NW 50 Rd 78 x 1/6"
- Free-standing base tank on four welded-on legs
- Stacking tank with four welded-on stacking legs

Sampling

- Weld-on thread NW 10 DIN 11851 with sealing cap (for the installation of sample tap)

Manhole

- Stable manhole neck seamlessly moulded from the tank shell, 420 x 320 mm, door with butterfly bow and hand wheel

Racking outlet

- With welded-on reinforcing plate with drilled hole 48 mm \varnothing to hold weld-on thread NW 40, NW 50 DIN 11851











Fill level

- Weld-on thread NW 10 DIN 11851 with sealing cap including fastening points at tank shell (for the installation of fill level indicator)

Bottom outlet

- Vaulted, stable tank bottom with integrally moulded forward down-slope for complete draining with moulded connection neck, inhibiting suction effect with bottom outlet neck NW 50 DIN 11851

SET-UP EXAMPLE FOR RECTANGULAR BASE TANK RS-MO / -STAPELTANK RA-MO

Item	Order No.
	<p>Rectangular base tank RS-MO-110-2300 liter</p> <ul style="list-style-type: none"> · h1 = approx. 1,797 mm · Standard equipment as on page 49 <p style="text-align: right;">RS-MO-110-2300</p>
	<p>Rectangular stacking tank RA-MO-110-2300 liter</p> <ul style="list-style-type: none"> · h5 = 1,548 mm, H = 1,797 mm (h1) + 70 mm (h4) + 1,548 mm (h5) = 3,415 mm, · $H_{\text{compl.}} = 3,415 \text{ mm (H)} + 80 \text{ mm (connection)}$ · + approx. 100 mm (height compensation) = approx. 3,595 mm · Standard equipment as on page 49 <p style="text-align: right;">RA-MO-110-2300</p>
	<p>Sampling (page 176)</p> <ul style="list-style-type: none"> · With sampling tap NW 10 DIN 11851 <p style="text-align: right;">64949</p>
	<p>Racking outlet (page 172)</p> <ul style="list-style-type: none"> · Welded gland with thread NW 50 DIN 11851 · With disc valve NW 50 DIN 11851 <p style="text-align: right;">KA-120D 64945</p>
	<p>Fill level (page 177)</p> <ul style="list-style-type: none"> · Fill level indicator NW 10 mounted <p style="text-align: right;">FS-130H</p>
	<p>Bottom outlet (page 172)</p> <ul style="list-style-type: none"> · With yeast plug · With disc valve NW 50 DIN 11851 <p style="text-align: right;">64945</p>
	<p>Temperature measurement (page 180)</p> <ul style="list-style-type: none"> · Bi-metal dial thermometer \varnothing 100 mm, measuring range - 20 °C to + 60 °C · Threaded sleeve with locking screw and cap nut NW 10 DIN 11851 <p style="text-align: right;">TM-140C</p>
	<p>Heating and cooling base tank (page 128)</p> <ul style="list-style-type: none"> · Double jacket C5 1.3 m² with welded gland G 1" for connection to available warm water / cold water source · Version 1, layout 50, connection position C5 <p style="text-align: right;">1C5</p>
	<p>Heating and cooling stacking tank (page 128)</p> <ul style="list-style-type: none"> · Double jacket C5 1.3 m² with welded gland G 1" for connection to available warm water / cold water source · Version 1, layout 50, connection position C5 <p style="text-align: right;">1C5</p>
	<p>Height compensation (page 184)</p> <ul style="list-style-type: none"> · With adjustable feet for tank legs (H = + approx. 100 mm) <p style="text-align: right;">46126</p>

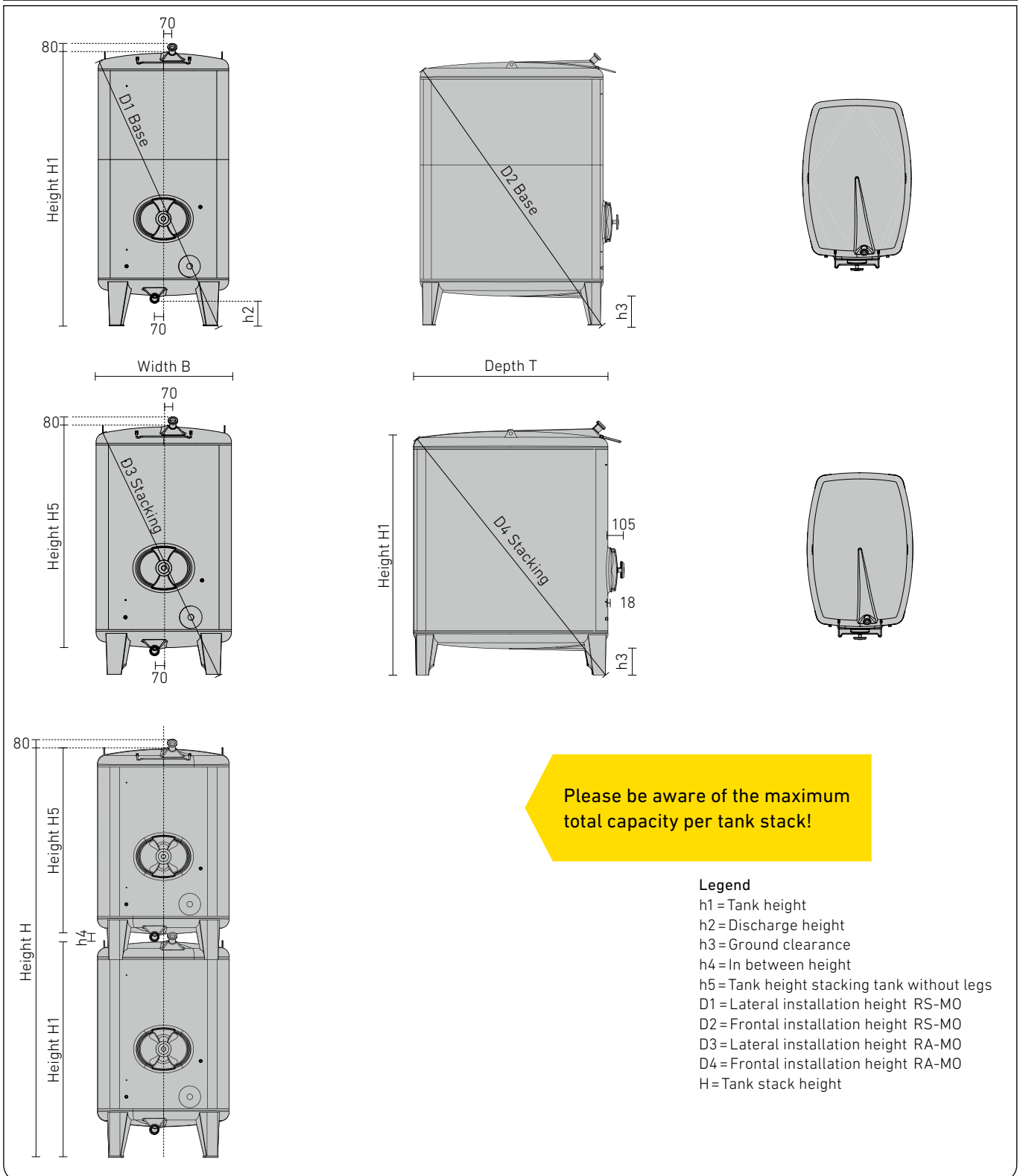
DIMENSIONS OF RECTANGULAR BASE TANK RS-MO / -STACKING TANK RA-MO

Intermediate sizes available

In case of 900 x 1,400 mm tank a 10 mm shell height equates to = 11.5 liter tank volume
 In case of 1,100 x 1,600 mm tank a 10 mm shell height equates to = 16.1 liter tank volume
 In case of 1,300 x 1,800 mm tank a 10 mm shell height equates to = 21.0 liter tank volume
 In case of 1,500 x 2,000 mm tank a 10 mm shell height equates to = 26.5 liter tank volume

Pricing for intermediate sizes

for intermediate sizes the price of the next larger size will apply (plus customization costs)

Option: Tank contact parts

made of AISI 316 stainless steel
 Surface III d (2R), marbled outside
 on special request

Brushed outer finish
 on special request

Larger tanks on request

RECTANGULAR BASE TANK RS-MO / STACKING TANK RA-MO: TANK CROSS SECTION 900 X 1,400 MM

Capacity	B	T	h1	h2	h3	D1	D2	h4	h5	D3	D4	H	Order No.	Order No.
liter	mm	mm	mm	mm	mm	mm	mm	mm	mm	mm	mm	mm	RS-MO	RA-MO
950	900	1,400	1,164	230	255	1,405	1,790	75	903	1,375	1,765	*	RS-MO-090-0950	RA-MO-090-0950
1,100	900	1,400	1,289	230	255	1,510	1,870	75	1,028	1,475	1,845	*	RS-MO-090-1100	RA-MO-090-1100
1,400	900	1,400	1,539	230	255	1,725	2,045	75	1,278	1,690	2,015	*	RS-MO-090-1400	RA-MO-090-1400
1,650	900	1,400	1,789	230	255	1,950	2,240	75	1,528	1,915	2,205	*	RS-MO-090-1650	RA-MO-090-1650
1,950	900	1,400	2,039	230	255	2,180	2,440	75	1,778	2,145	2,405	*	RS-MO-090-1950	RA-MO-090-1950
2,250	900	1,400	2,289	230	255	2,415	2,650	75	2,028	2,380	2,615	*	RS-MO-090-2250	RA-MO-090-2250
2,500	900	1,400	2,539	230	255	2,665	2,865	75	2,278	2,625	2,835	*	RS-MO-090-2500	RA-MO-090-2500
2,800	900	1,400	2,789	230	255	2,915	3,090	75	2,528	2,855	3,055	*	RS-MO-090-2800	RA-MO-090-2800
3,100	900	1,400	3,039	230	255	3,160	3,313	75	-	-	-	-	RS-MO-090-3100	-

Tank cross section 900x1,400mm; maximum total volume per tank stack 4,000 liter

RECTANGULAR BASE TANK RS-MO / -STACKING TANK RA-MO: TANK CROSS SECTION 1,100 X 1,600 MM

Capacity	B	T	h1	h2	h3	D1	D2	h4	h5	D3	D4	H	Order No.	Order No.
liter	mm	mm	mm	mm	mm	mm	mm	mm	mm	mm	mm	mm	RS-MO	RA-MO
1,500	1,100	1,600	1,297	230	245	1,610	2,015	70	1,048	1,580	1,990	*	RS-MO-110-1500	RA-MO-110-1500
1,900	1,100	1,600	1,547	230	245	1,810	2,175	70	1,298	1,780	2,150	*	RS-MO-110-1900	RA-MO-110-1900
2,300	1,100	1,600	1,797	230	245	2,025	2,355	70	1,548	1,990	2,325	*	RS-MO-110-2300	RA-MO-110-2300
2,700	1,100	1,600	2,047	230	245	2,245	2,545	70	1,798	2,210	2,515	*	RS-MO-110-2700	RA-MO-110-2700
3,100	1,100	1,600	2,297	230	245	2,475	2,750	70	-	-	-	-	RS-MO-110-3100	-
3,500	1,100	1,600	2,547	230	245	2,705	2,960	70	-	-	-	-	RS-MO-110-3500	-
3,900	1,100	1,600	2,797	230	245	2,940	3,175	70	-	-	-	-	RS-MO-110-3900	-
4,300	1,100	1,600	3,047	230	245	3,185	3,395	70	-	-	-	-	RS-MO-110-4300	-

Tank cross section 1,100x1,600mm; maximum total volume per tank stack 5,000 liter

RECTANGULAR BASE TANK RS-MO / -STACKING TANK RA-MO: TANK CROSS SECTION 1,300 X 1,800 MM

Capacity	B	T	h1	h2	h3	D1	D2	h4	h5	D3	D4	H	Order No.	Order No.
liter	mm	mm	mm	mm	mm	mm	mm	mm	mm	mm	mm	mm	RS-MO	RA-MO
2,000	1,300	1,800	1,316	195	235	1,720	2,165	90	1,084	1,715	2,160	*	RS-MO-130-2000	RA-MO-130-2000
2,500	1,300	1,800	1,566	195	235	1,905	2,315	90	1,334	1,905	2,315	*	RS-MO-130-2500	RA-MO-130-2500
3,000	1,300	1,800	1,816	195	235	2,110	2,480	90	1,584	2,110	2,480	*	RS-MO-130-3000	RA-MO-130-3000
3,500	1,300	1,800	2,066	195	235	2,325	2,665	90	1,834	2,325	2,665	*	RS-MO-130-3500	RA-MO-130-3500
4,000	1,300	1,800	2,316	195	235	2,540	2,855	90	2,084	2,540	2,855	*	RS-MO-130-4000	RA-MO-130-4000
4,500	1,300	1,800	2,566	195	235	2,765	3,060	90	-	-	-	-	RS-MO-130-4500	-
5,000	1,300	1,800	2,816	195	235	2,995	3,265	90	-	-	-	-	RS-MO-130-5000	-
5,600	1,300	1,800	3,066	195	235	3,230	3,480	90	-	-	-	-	RS-MO-130-5600	-

Tank cross section 1,300x1,800mm; maximum total volume per tank stack 7,000 liter

* The respective height H is calculated as follows: $H = h1 + h4 + h5$

RECTANGULAR BASE TANK RS-MO / -STACKING TANK RA-MO: TANK CROSS SECTION 1,500 X 2,000 MM

Capacity	B	T	h1	h2	h3	D1	D2	h4	h5	D3	D4	H	Order No.	Order No.
liter	mm	mm	mm	mm	mm	mm	mm	mm	mm	mm	mm	mm	RS-MO	RA-MO
2,600	1,500	2,000	1,383	215	250	1,875	2,350	110	1,129	1,890	2,360	*	RS-MO-150-2600	RA-MO-150-2600
3,200	1,500	2,000	1,633	215	250	2,055	2,490	110	1,379	2,070	2,505	*	RS-MO-150-3200	RA-MO-150-3200
3,900	1,500	2,000	1,883	215	250	2,250	2,655	110	1,629	2,270	2,670	*	RS-MO-150-3900	RA-MO-150-3900
4,500	1,500	2,000	2,133	215	250	2,455	2,830	110	1,879	2,475	2,845	*	RS-MO-150-4500	RA-MO-150-4500
5,200	1,500	2,000	2,383	215	250	2,670	3,015	110	2,129	2,690	3,030	*	RS-MO-150-5200	RA-MO-150-5200
5,800	1,500	2,000	2,633	215	250	2,890	3,210	110	2,379	2,905	3,225	*	RS-MO-150-5800	RA-MO-150-5800
6,500	1,500	2,000	2,883	215	250	3,110	3,410	110	-	-	-	-	RS-MO-150-6500	-
7,200	1,500	2,000	3,133	215	250	3,440	3,620	110	-	-	-	-	RS-MO-150-7200	-

Tank cross section 1,500 x 2,000 mm; maximum total volume per tank stack 10,200 liter

* The respective height H is calculated as follows: $H = h1 + h4 + h5$

SLANTED RECTANGULAR TANKS FOR SLANTED CELLAR CEILINGS

Tank cross section	Dimension A	Dimension B	Nominal volume RS-MO/ RA-MO minus	Order No.
mm	mm	mm		
900 x 1,400	650	490	130 liter	OB 040Q
1,100 x 1,600	750	600	160 liter	OB 040Q
1,300 x 1,800	850	713	210 liter	OB 040Q
1,500 x 2,000	950	847	260 liter	OB 040Q

(not possible with base tank for tank stacks)

Perfect use of space for
vaulted cellars!

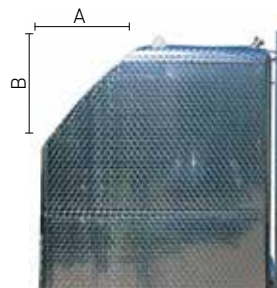

Fermentation and storage tank

Square base tank RS-MO-Q

Square stacking tank RA-MO-Q



APPLICATION RANGE (PRESSURELESS)

- Storage
- Maturation
- Fermentation
- Mixing
- Processes

Ideal for

- Non-alcoholic beverages
- Alcoholic beverages
- Food
- Plant construction
- Industry

In case you wish to square the circle, Speidel offers its high-quality fermentation and storage tanks also with a square base. This allows you to use the space available to the max. The perfect exploitation of space is truly unique and only Speidel manufactures square tanks of such high quality as standard tanks. This is nothing less than quality squared!

Our square tanks have the same properties as our rectangular tanks: maximum stability, dimensionally stable tank top and complete filling and draining. Easy cleaning is guaranteed due to smooth surfaces and perfect weld seams.

**Square for perfect
use of space!**



STANDARD EQUIPMENT FOR SQUARE BASE TANK RS-MO-Q / STACKING TANK RA-MO-Q

- For non-pressurized use
- Tank shell and tank bottom made of AISI 304 stainless steel, surface IIIId (2R), marbled outside
- Tank top made of AISI 316 stainless steel, surface IIIId (2R), marbled outside
- With lifting lugs
- Base tank from 2,000 mm tank height upwards and stacking tank ladder safety bow
- Vaulted, stable tank top with moulded-on forward up-slope for complete filling and ventilation assuring a very small air contact area
- Moulded connection neck with filling and vent neck, external thread NW 50 Rd 78 x 1/6"
- Free-standing base tank on four welded-on legs
- Stacking tank with four welded-on stacking legs

Sampling

- Weld-on thread NW 10 DIN 11851 with sealing cap (for the installation of sample tap)

Manhole

- Stable manhole neck seamlessly moulded out of the tank shell, stable manhole neck, 420 x 320 mm, door with butterfly bow and hand wheel

Racking outlet

- With welded-on reinforcing plate with drilled hole 48 mm ø to hold weld-on thread NW 40, NW 50 DIN 11851

Fill level

- Weld-on thread NW 10 DIN 11851 with sealing cap including fastening points at tank shell (for the installation of fill level indicator)

Bottom outlet





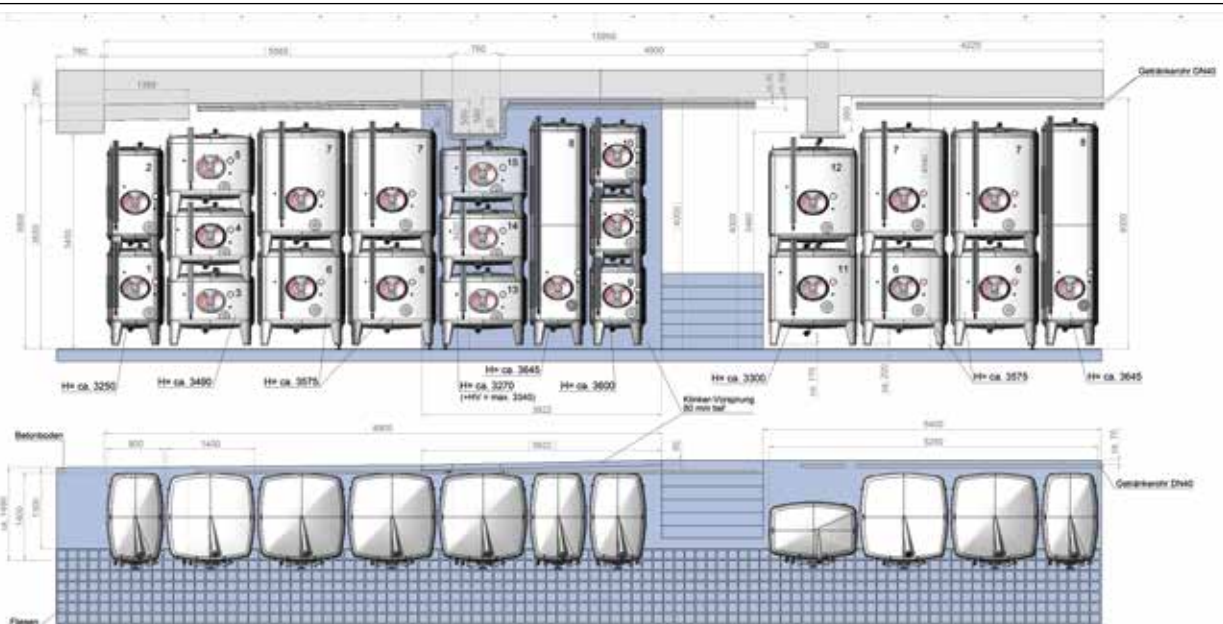



- Vaulted, stable tank bottom with integrally moulded forward down-slope for complete draining with moulded connection port, inhibiting suction effect with bottom outlet neck NW 50 DIN 11851

EXAMPLE CELLAR LAYOUT



Pos	Anzahl [Stk.]	Type	Tankquerschnitt [mm]	Höhe h5 [mm]	Höhe h1 [mm]	Nenn-Inhalt [Ltr.]	Gesamthalt [Ltr.]
1	1	RS-MO-090-S 0138	900x1400	∅	1539	1400	1400
2	1	RS-MO-090 0133	900x1400	1528	∅	1650	1650
3	1	RS-MO-141-S 0002	1400x1400	∅	ca. 1172	1500	3000
4	1	RA-MO-141-S 0004	1400x1400	ca. 919	∅	1500	3000
15	1	RA-MO-141-S 0001	1400x1400	ca. 894	∅	1430	1430
5	1	RA-MO-141-S 0003	1400x1400	ca. 1044	∅	1700	1700
6	4	RS-MO-141-S 0003	1400x1400	∅	ca. 1547	2150	9000
7	4	RA-MO-141-S 0002	1400x1400	ca. 1794	∅	3000	12000
8	2	RS-MO-090-S 0138	900x1400	∅	3539	3600	7200
9	1	RS-MO-090-S 0137	900x1400	∅	1289	1100	1100
10	2	RA-MO-090-S 0050	900x1400	1028	∅	1100	2200
11	1	RS-MO-090-S 0138	900x1400	1528	∅	1400	1400
12	1	RA-MO-090-S 0049	900x1400	1528	∅	1650	1650
13	1	RS-MO-141-S 0009	1400x1400	∅	ca. 1147	1450	1450
14	1	RA-MO-141-S 0008	1400x1400	ca. 894	∅	1450	1450
							46290

SET-UP EXAMPLE FOR SQUARE BASE TANK RS-MO-Q

Item	Order No.
	<p>Square base tank RS-MO-141-2600 liter</p> <ul style="list-style-type: none"> · $h_1 = 1,792 \text{ mm}$, $H_{\text{compl.}} = 1,792 \text{ mm (h}_1) + 270 \text{ mm (dome)}$ · $+ 100 \text{ mm (height compensation)} = \text{approx. } 2,162 \text{ mm}$ · Standard equipment as on page 49 <p style="text-align: right;">RS-MO-141-2600</p>
	<p>Ventilation / Filling (page 168)</p> <ul style="list-style-type: none"> · Filling neck NW 400 on tank top, position: forward / vertical · Tank top with bead extrusion for total ventilation, $H = + 270 \text{ mm}$ <p style="text-align: right;">OB-0400</p>
	<p>Sampling (page 176)</p> <ul style="list-style-type: none"> · With sampling tap NW 10 DIN 11851 <p style="text-align: right;">64949</p>
	<p>Racking outlet (page 172)</p> <ul style="list-style-type: none"> · Welded gland with thread NW 50 DIN 11851 · With disc valve NW 50 DIN 11851 <p style="text-align: right;">KA-120D 64945</p>
	<p>Fill level (page 177)</p> <ul style="list-style-type: none"> · Fill level indicator NW 10 mounted <p style="text-align: right;">FS-130H</p>
	<p>Bottom outlet (page 172)</p> <ul style="list-style-type: none"> · With disc valve NW 50 DIN 11851 <p style="text-align: right;">64945</p>
	<p>Temperature measurement (page 172)</p> <ul style="list-style-type: none"> · Bi-metal dial thermometer $\varnothing 100 \text{ mm}$, measuring range $- 20 \text{ }^\circ\text{C}$ to $+ 60 \text{ }^\circ\text{C}$ · Threaded sleeve with locking screw and cap nut NW 10 DIN 11851 <p style="text-align: right;">TM-140C</p>
	<p>Heating and cooling (page 128)</p> <ul style="list-style-type: none"> · Double jacket C6 1.5 m^2 with welded gland thread G 1" for connection to available warm water / cold water source · Version 1, layout 51, connection position C6 <p style="text-align: right;">1C6</p>
	<p>Height compensation (page 184)</p> <ul style="list-style-type: none"> · With adjustable feet for tank legs ($H = + \text{approx. } 100 \text{ mm}$) <p style="text-align: right;">46126</p>

DIMENSIONS SQUARE BASE TANK RS-MO-Q / STACKING TANK RA-MO-Q

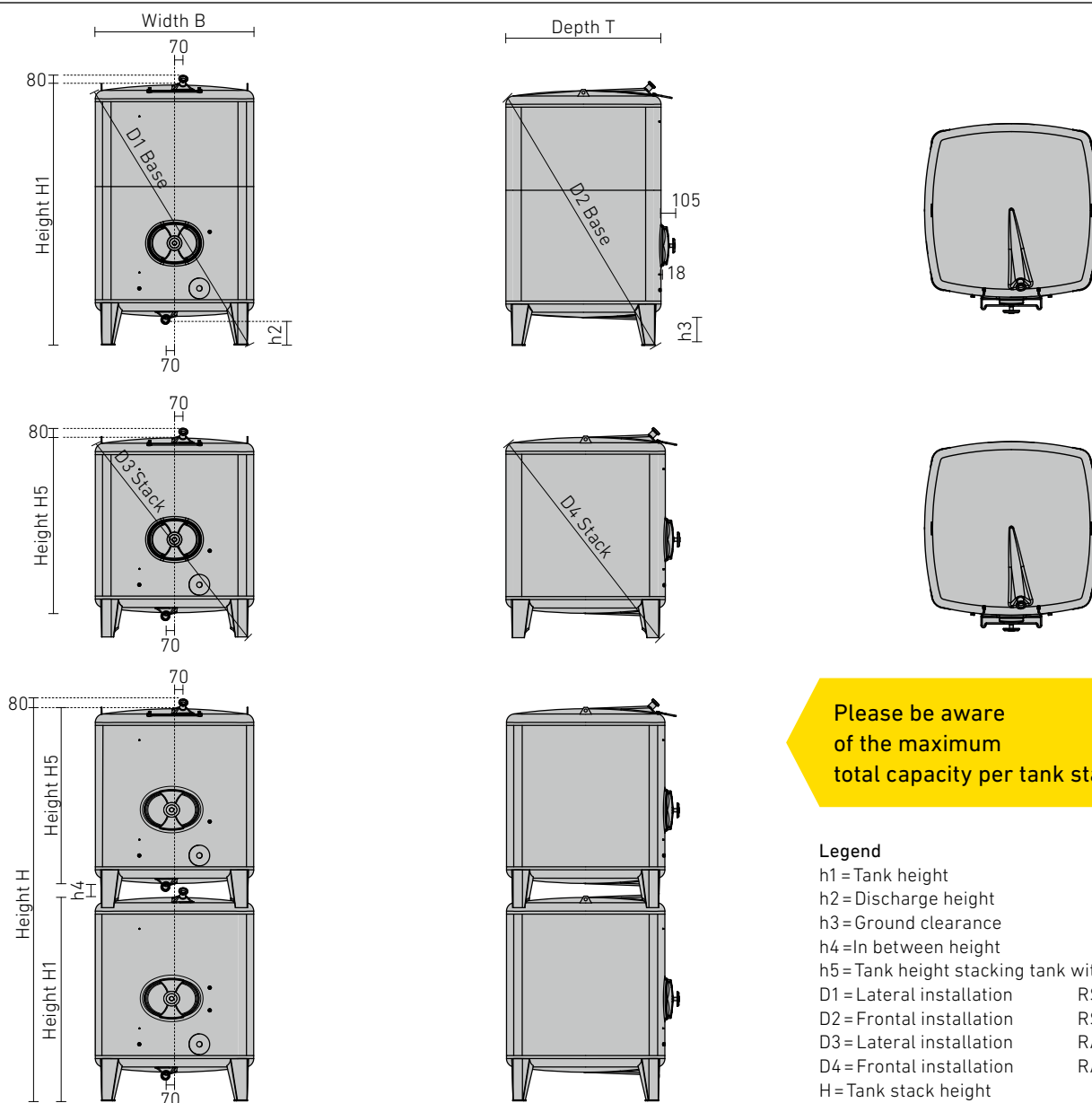

SQUARE BASE TANK RS-MO-Q / STACKING TANK RA-MO-Q

Capacity	B	T	h1	h2	h3	D1	D2	h4	h5	D3	D4	H	Order No.	Order No.
liter	mm	mm	mm	mm	mm	mm	mm	mm	mm	mm	mm	mm	RS-MO	RA-MO
1,500	1,400	1,400	1,172	198	250	1,755	1,755	75	919	1,730	1,730	*	RS-MO-141-1500	RA-MO-141-1500
1,700	1,400	1,400	1,297	198	250	1,840	1,840	75	1,044	1,810	1,810	*	RS-MO-141-1700	RA-MO-141-1700
2,150	1,400	1,400	1,547	198	250	2,015	2,015	75	1,294	1,985	1,985	*	RS-MO-141-2150	RA-MO-141-2150
2,600	1,400	1,400	1,792	198	250	2,210	2,210	75	1,544	2,180	2,180	*	RS-MO-141-2600	RA-MO-141-2600
3,000	1,400	1,400	2,047	198	250	2,415	2,415	75	1,794	2,380	2,380	*	RS-MO-141-3000	RA-MO-141-3000
3,400	1,400	1,400	2,297	198	250	2,625	2,625	75	-	-	-	-	RS-MO-141-3400	-
3,900	1,400	1,400	2,547	198	250	2,845	2,845	75	-	-	-	-	RS-MO-141-3900	-
4,350	1,400	1,400	2,797	198	250	3,070	3,070	75	-	-	-	-	RS-MO-141-4350	-
4,800	1,400	1,400	3,047	198	250	3,295	3,295	75	-	-	-	-	RS-MO-141-4800	-

Tank cross section 1,400 × 1,400 mm; maximum total volume per tank stack 6,000 liter

Intermediate sizes available

In case of 1,400 x 1,400 mm tank a 10 mm shell height equates to = 18.2 liter tank volume

Pricing for intermediate sizes

For intermediate sizes the price of the next larger size will apply (plus customization costs)

Larger tank sizes on request.

* The respective height H is calculated as follows: $H = h1 + h4 + h5$



Multi-compartment tank MS-MO

Don't reduce volume! Save on height! Speidel's multi-compartment tanks MS-MO have perfectly connected multiple tank compartments. In case you wish to obtain a perfect look even in case of different individual tank capacities, the MS-MO is first choice!

Even when combined with single tanks, the use of the MS-MO allows you to obtain a uniform line of tanks at the same total holding capacity. This option offers the possibility to process smaller batches while perfectly using the available room height. Up to three compartments available per tank.

APPLICATION RANGE (PRESSURELESS)

- Storage
- Maturation
- Fermentation
- Mixing
- Processes

Ideal for

- Wine
- Must
- Spirits
- Juice
- Non-alcoholic beverages
- Alcoholic beverages

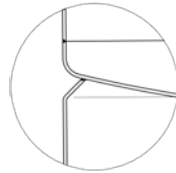

- Gapless and free of voids
- Easy cleaning and tank sterilisation





STANDARD EQUIPMENT FOR MULTI-COMPARTMENT TANK MS-MO

- For non-pressurized use

Upper tank compartment

- The volume of the upper tank compartment corresponds with a standard tank size
- Vaulted, stable tank top
- Tank up to \varnothing of 2,000 mm with integrally moulded forward up-slope for complete filling and ventilation assuring a very small air contact area
- From tank- \varnothing of 2,200 mm upwards welded-on connection neck located in top centre with filling and vent neck AG NW 50 Rd 78 x 1/6"
- With lifting lugs
- From 2,000 mm tank height upwards with ladder safety bow
- Vaulted, stable inserted bottom
- Up to tank- \varnothing of 2,000 mm with integrally moulded forward down-slope for complete draining moulded connection neck, impending suction effect with bottom outlet neck NW 50 DIN 11851
- From tank- \varnothing of 2,200 mm upwards with discharge cup located in the centre of the tank's bottom and forward drawn discharge pipe, outlet with thread NW 50 DIN 11851

Middle tank compartment

- Inserted bottom of the upper tank compartment with filling and vent neck external thread NW 50 Rd 78 x 1/6" for complete filling and ventilation
- Vaulted, stable inserted bottom
- Up to tank- \varnothing of 2,000 mm with integrally moulded forward down-slope for complete draining moulded connection neck, impending suction effect with bottom outlet neck NW 50 DIN 11851
- From tank- \varnothing of 2,200 mm upwards with discharge cup located in the centre of the tank's bottom and forward drawn discharge pipe, outlet with thread NW 50 DIN 11851

Lower tank compartment









- Inserted bottom of the upper respectively middle tank compartment with filling and ventilation neck NW 50 Rd 78 x 1/6" for complete filling and vent
- Vaulted, stable tank bottom
- Up to tank- \varnothing of 2,000 mm with integrally moulded forward down-slope for complete draining
- Moulded connection neck, impending suction effect with bottom outlet neck NW 50 DIN 11851

- From tank- \varnothing of 2,200 mm upwards with discharge cup located in the centre of the tank's bottom and forward drawn discharge pipe, outlet with thread NW 50 DIN 11851
- Free-standing on welded-on box-shaped legs – perfect stability and force transmission into the tank shell

Standard equipment for each tank compartment

- Inserted bottom made of AISI316
- Sampling: welded-on thread NW 10 DIN 11851 with sealing cap (for the installation of sampling tap)
- Stable manhole neck seamlessly moulded from the tank shell, 420 x 320 mm, door with butterfly bow and hand wheel
- Racking outlet: Reinforcing plate with drilled hole 48 mm \varnothing (to hold flap valve Gr. 37 or weld-on thread NW 40, NW 50 DIN 11851)
- Fill level: Weld-on thread NW 10 DIN 11851 with sealing cap including fastening points on tank shell (for the installation of fill level indicator)

SET-UP EXAMPLE FOR MULTI-COMPARTMENT TANK MS-MO

Item	Order No.
	<p>FS-MO base tank FS-MO-120-2000 liter</p> <ul style="list-style-type: none"> · $h_1 = 2,173 \text{ mm}$, $H_{\text{compl.}} = 2,173 \text{ mm (h}_1) + 80 \text{ mm (connection)}$ + 100 mm (height compensation) = approx. 2,353 mm · Standard equipment as on page 59 <p style="text-align: right;">FS-MO-120-2000</p>
<p>Multiple-compartment tank</p> <ul style="list-style-type: none"> · Upper tank compartment 1,000 liter · Lower tank compartment 1,000 liter 	MS-MO-120-S
Equipment for each tank compartment:	
	<p>Sampling (page 176)</p> <ul style="list-style-type: none"> · With sampling tap NW 10 DIN 11851 <p style="text-align: right;">64949</p>
	<p>Racking outlet (page 172)</p> <ul style="list-style-type: none"> · With mounted flap valve Gr. 37 <p style="text-align: right;">KA-120I</p>
	<p>Fill level (page 177)</p> <ul style="list-style-type: none"> · Mounted fill level indicator NW 10 <p style="text-align: right;">FS-130H</p>
	<p>Bottom outlet (page 172)</p> <ul style="list-style-type: none"> · With disc valve NW 50 DIN 11851 <p style="text-align: right;">64945</p>
	<p>Temperature measurement (page 180)</p> <ul style="list-style-type: none"> · Bi-metal dial thermometer $\varnothing 100 \text{ mm}$, measuring range $-20 \text{ }^\circ\text{C}$ to $+60 \text{ }^\circ\text{C}$ · Threaded sleeve with locking screw and cap nut NW 10 DIN 11851 <p style="text-align: right;">TM-140C</p>
	<p>Heating and cooling jacket lower tank compartment (page 128)</p> <ul style="list-style-type: none"> · Double jacket shape A2 1.3 m^2 with welded gland thread G 1" for connection to available warm water / cold water source · Version 1, layout 15, connection position A2 <p style="text-align: right;">1A2</p>
	<p>Heating and cooling jacket upper tank compartment (page 128)</p> <ul style="list-style-type: none"> · Double jacket shape A2 1.3 m^2 with welded gland thread G 1" for connection to available warm water / cold water source · Version 1, layout 15, connection position A2 <p style="text-align: right;">1A2</p>
Equipment for each tank:	
	<p>Adjustable feet (page 184)</p> <ul style="list-style-type: none"> · With adjustable feet for tank legs ($H = +$ approx. 100 mm) <p style="text-align: right;">46127</p>

DIMENSIONS OF MULTI-COMPARTMENT TANK MS-MO

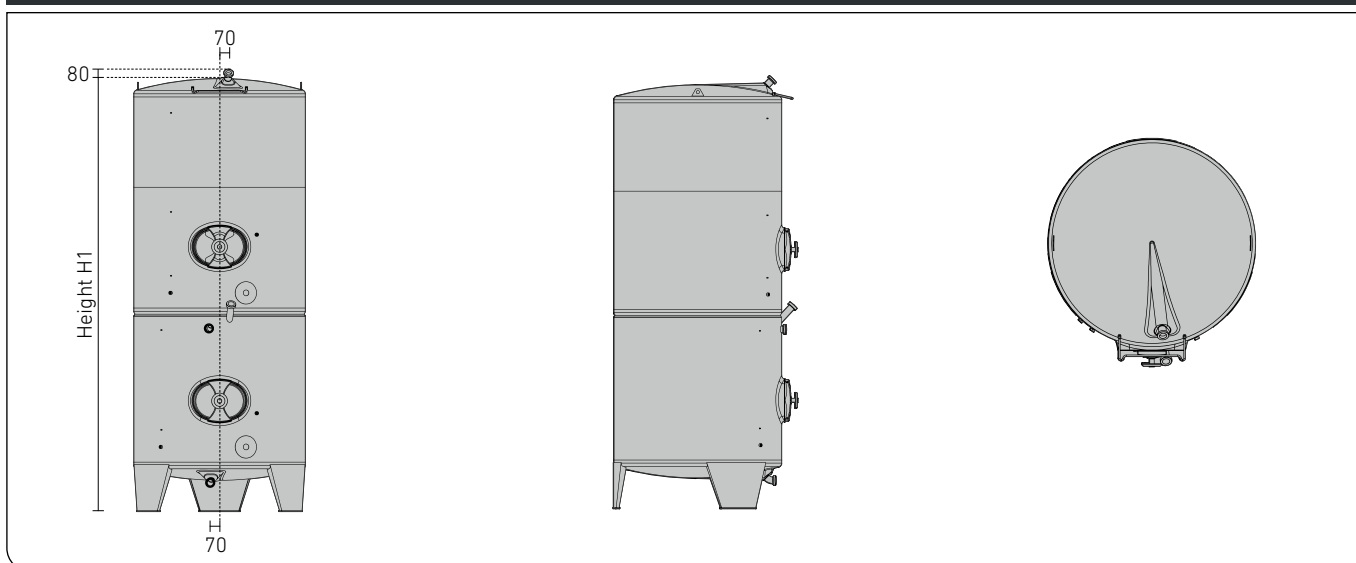

MULTI-COMPARTMENT TANK MS-MO

Ø mm	Minimum capacity for each tank compartment liter	Order No.
		mounted
1.000	650	MS-MO-100-S
1.200	900	MS-MO-120-S
1.400	1.200	MS-MO-140-S
1.600	1.550	MS-MO-160-S
1.800	1.900	MS-MO-180-S
2.000	2.350	MS-MO-200-S
2.200	3.950	MS-MO-220-S
2.400	4.700	MS-MO-240-S
2.600	5.800	MS-MO-260-S
2.800	6.750	MS-MO-280-S
3.000	8.800	MS-MO-300-S
900x1.400	850	RMS-MO-090-S
1.100x1.600	1.250	RMS-MO-110-S
1.300x1.800	1.650	RMS-MO-130-S
1.500x2.000	2.200	RMS-MO-150-S
1.400x1.400	1.450	RMS-MO-141-S

Tanks for mixing, transportation and storage



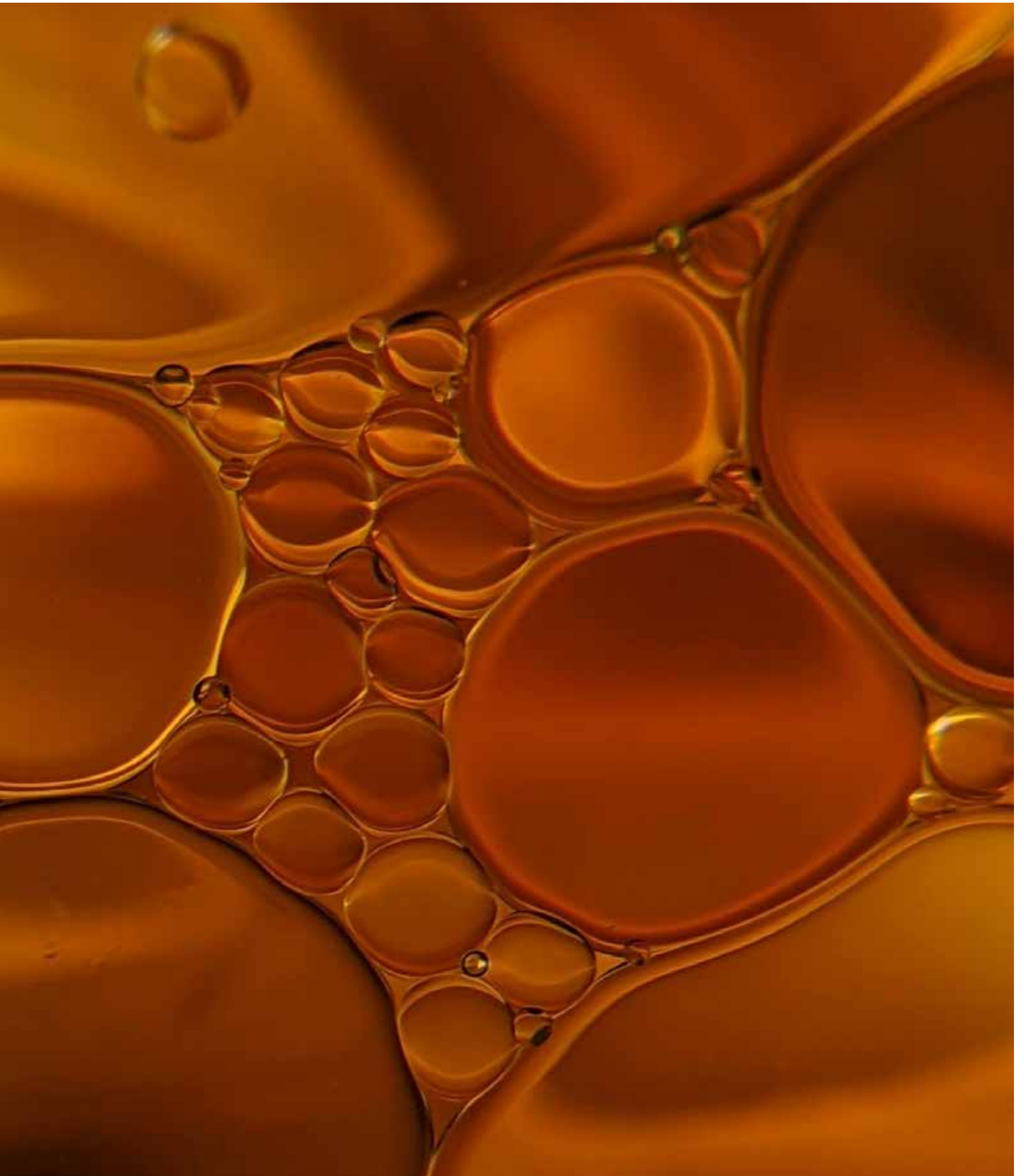

Sugar dissolving and mixing tank SO-Z



APPLICATION RANGE (PRESSURELESS)

- Transportation
- Blending
- Stirring
- Mixing
- Storage

Ideal for

- Beverages
- Food
- Plant construction
- Industry

Whether it is about mixing, blending or stirring: because of its unlimited application possibilities, Speidel's SO-Z tank is indispensable for almost any enterprise.

Our customers appreciate the tank's perfect functioning and its outstanding price-performance ratio. The tank's PE-base allows easy and flexible transportation. The base can be easily accessed from underneath by forklift / pallet truck. At the same time the base serves as buffer / bumper.

This tank combines both our know-how in matters of stainless steel and our expertise in plastics. The tank's PE-base is home-made and is therefore ideally customised for the tank. It fits like a glove.

For forklift and pallet truck transportation





STANDARD EQUIPMENT FOR SUGAR DISSOLVING AND MIXING TANK SO-Z

- For non-pressurized use
- AISI 304 stainless steel, surface IIIId (2R), marbled outside
- Open tank top with strengthening rim
- Connecting neck for stirring device with external thread connection 37 W 47 x 1/9"
- Vaulted, stable tank bottom with integrally moulded forward down-slope for complete draining
- Moulded connection neck with bottom outlet: in case of 820 mm \varnothing external thread NW 40 DIN 11851, from 1,000 mm \varnothing upwards external thread NW 50 DIN 11851
- PE-transportation and storage base, accessible from underneath by forklift / pallet truck
- Up to 530 liter capacity with PE-transportation and storage base, accessible from two sides by forklift / pallet truck
- From 750 liter capacity onwards with PE-transportation and storage base, accessible from four sides by forklift / pallet truck

DIMENSIONS OF SUGAR DISSOLVING AND MIXING TANK SO-Z

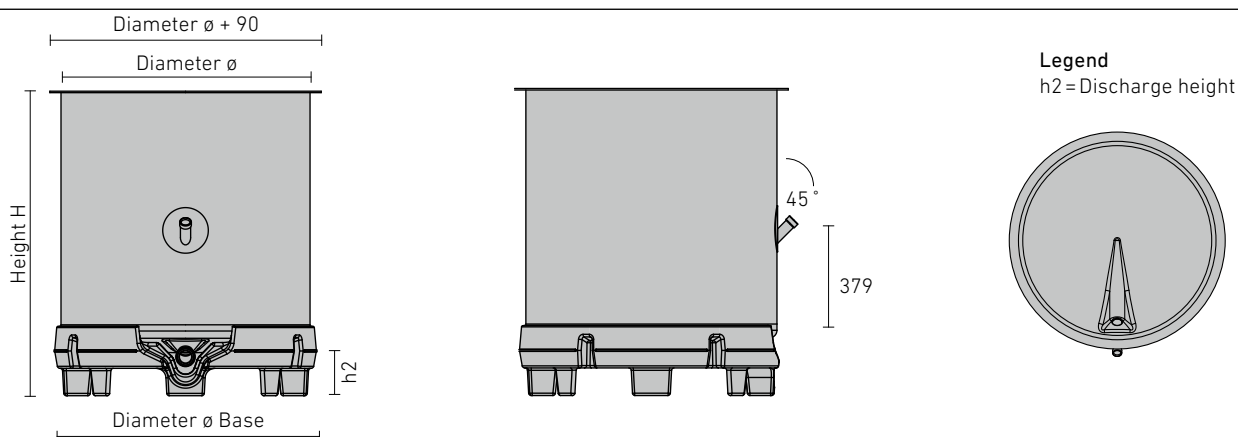

Capacity	\varnothing Tank	\varnothing Base	H	h2	Discharge	Order No.
liter	mm	mm	mm	mm	NW	
530	820	873	1,315	160	40	SO-Z-082-0530
750	1,000	1,054	1,218	135	50	SO-Z-100-0750
1,000	1,200	1,256	1,218	115	50	SO-Z-120-1000

Stirring device traverse with flap lid and stirring device on request

Mixing and transportation tank RO-Z



Let's roll! The robust mixing and transportation tank RO-Z is completely made of stainless steel. It can be easily moved even without forklift due to its four top-quality

fixed rollers and guide rollers (made of polyamide) for heavy loads. The RO-Z can be used for stirring, mixing or blending.

APPLICATION RANGE (PRESSURELESS)

- Transportation
- Blending
- Stirring
- Mixing
- Storage

Ideal for

- Beverages
- Food
- Plant construction
- Industry

For transportation without
forklift or pallet truck





STANDARD EQUIPMENT FOR MIXING AND TRANSPORTATION TANK RO-Z

- For non-pressurized use
- AISI 304 stainless steel, surface IIIId (2R), marbled outside
- Open tank top with strengthening rim
- Connecting neck for stirring device with external thread connection 37 W 47 x 1/9"
- Vaulted, stable tank bottom with integrally moulded forward down-slope for complete draining
- Moulded connection neck with bottom outlet: in case of 820 mm \varnothing external thread NW 40 DIN 11851, from 1,000 mm \varnothing upwards external thread NW 50 DIN 11851
- With two fixed rollers and two guide rollers made of polyamide \varnothing 150 mm, case made of stainless steel, guide rollers with brake

DIMENSIONS OF MIXING AND TRANSPORTATION TANK RO-Z

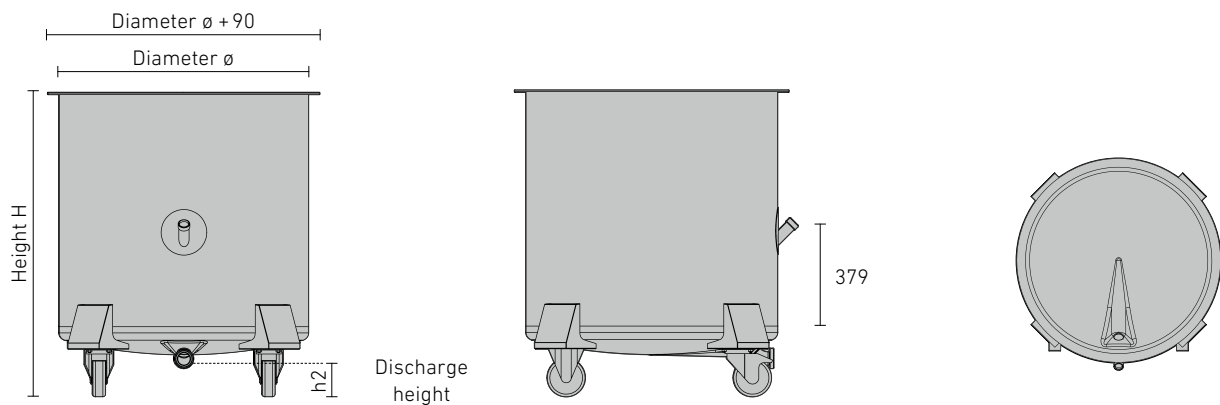

Capacity liter	\varnothing Tank mm	H mm	h2 mm	Order No.
530	820	1,302	150	RO-Z -082 -0530
750	1,000	1,219	150	RO-Z -100 -0750
1,000	1,200	1,221	125	RO-Z -120 -1000

Transportation and tipping tank KO



The KO tank can be used for mixing / blending and transportation, but also as tilting tank.

It can be easily transported with a forklift or a pallet truck. With the forklift profiles the container can be turned by using a tilting device on the forklift.

APPLICATION RANGE (PRESSURELESS)

- Transportation
- Blending
- Stirring
- Mixing
- Storage

Ideal for

- Beverages
- Food
- Plant construction
- Industry

For forklift and pallet
truck transportation





STANDARD EQUIPMENT FOR TRANSPORTATION AND TIPPING TANK KO

- For non-pressurized use
- With forklift profile 120 x 60 mm, internal dimension form 114 mm x 54 mm
- Tank bottom as flat bottom
- AISI 304 stainless steel, surface IIIId (2R), shell marbled outside
- Tank open on top with strengthening rim, width of rim approx. 42 mm
- Stackable maximum two filled tanks
- With stainless steel tube feet

DIMENSIONS OF TRANSPORTATION AND TIPPING TANK KO

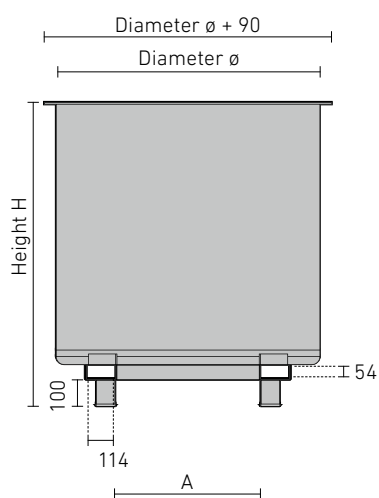

Please pay attention to the internal dimensions of the forklift profiles

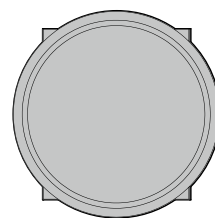

Capacity liter	\varnothing Tank mm	H mm	Base length mm	A mm	Order No.
380	1,000	653	900	555	KO-100-0380
550	1,000	903	900	555	KO-100-0550
750	1,000	1,153	900	555	KO-100-0750
1,050	1,200	1,153	998	695	KO-120-1050

Transportation tank SD-T (vertical)



APPLICATION RANGE (PRESSURELESS)

- Transport
- Storage

Ideal for

- Wine
- Must
- Spirits
- Fermented beverages

The transport tank SD-T is exactly the right thing for both in-house and external transportation. The tank has many useful details that facilitate operations.

Lifting lugs that allow to protect the loaded goods in the most reliable manner also in case of longer transport distances are fixed to the edge of the vaulted tank top.

Depending on the tank's size, forklifts / pallet trucks can access the tank from either two or four sides. The tank's top-quality PE-base made by Speidel fits perfectly. In addition to being accessible from underneath, the base also works as buffer. It guarantees long-lasting and reliable transport safety.

For forklift and pallet
truck transportation





STANDARD EQUIPMENT FOR TRANSPORTATION TANK SD-T (VERTICAL)

- For non-pressurized use
- AISI 304 stainless steel, surface III d (2R), marbled outside
- Vaulted tank top with lifting lugs
- Up to 525 liter capacity (820 mm \varnothing) with filler neck 220 mm, lid with inner clamp fastener
- From 650 liter capacity upwards (1,000 mm \varnothing) with filler neck 400 mm, flap lid with outer clamp fastener, stainless steel vent neck external thread G 1 1/2" (BSP) with sealing cap
- Vaulted tank bottom with bottom outlet external thread G 1 1/4" (BSP)
- Up to 525 liter capacity (820 mm \varnothing) with PE-transportation and storage base, accessible from two sides by forklift / pallet truck, screwed
- From 650 liter capacity upwards (1,000 mm \varnothing) with PE-transportation and storage base, accessible from four sides by forklift / pallet truck, screwed

DIMENSIONS OF TRANSPORTATION TANK SD-T (VERTICAL)

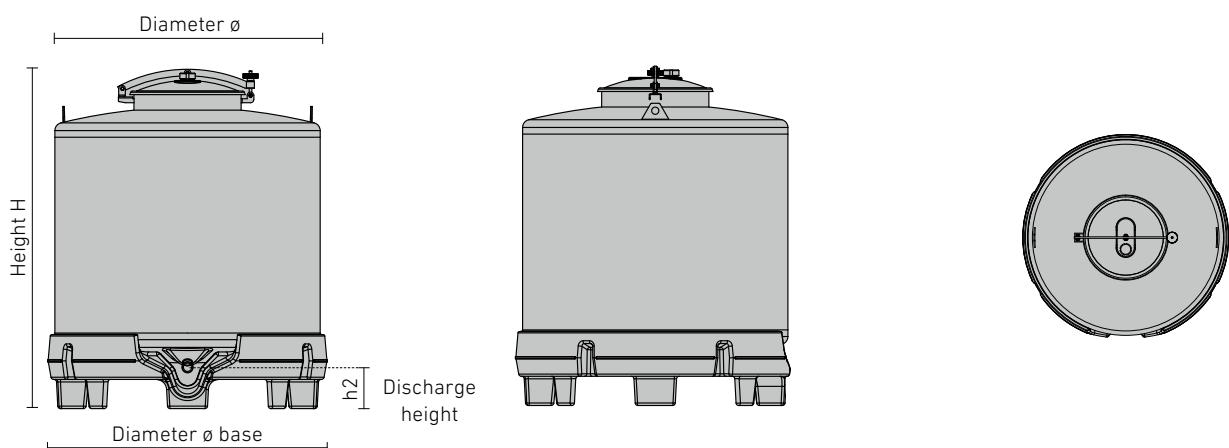

Capacity	\varnothing Tank	\varnothing Base	H	h2	Order No.
liter	mm	mm	mm	mm	
320	820	873	925	160	SD-T -082 -0320
525	820	873	1,322	160	SD-T -082 -0525
650	1,000	1.054	1,310	135	SD-T -100 -0650
1,000	1,200	1.256	1,340	115	SD-T -120 -1000

Transportation tank LD-T (horizontal)



If you prefer to transport horizontally, no problem! The transportation tank LD-T offers all the advantages of its upright companion. It has a safely lockable lid with vent neck and a bottom outlet that allows for the tank's complete draining.

The tank is lying on a stable PE-base made by Speidel and is accessible from four sides by forklift. The plastic base not only makes the LD-T absolutely stable. It also helps to protect the tank from jostles and bumps. This way you will be able to enjoy your tank for many years to come.

APPLICATION RANGE (PRESSURELESS)

- Transportation
- Blending
- Stirring
- Mixing
- Storage

Ideal for

- Beverages
- Food
- Plant construction
- Industry

**For forklift and pallet
truck transportation**





STANDARD EQUIPMENT FOR TRANSPORTATION TANK LD-T (HORIZONTAL)

- For non-pressurized use
- AISI 304 stainless steel, surface IIIId (2R), marbled outside
- Filler neck NW 400 arranged in the centre of the tank top, flap lid with vent neck NW 50 Rd 78 x 1/6" with sealing cap
- Discharge outlet NW 50 DIN 11851
- Stable on PE-transportation and storage base, accessible on four sides by forklift / pallet truck

DIMENSIONS OF TRANSPORTATION TANK LD-T (HORIZONTAL)

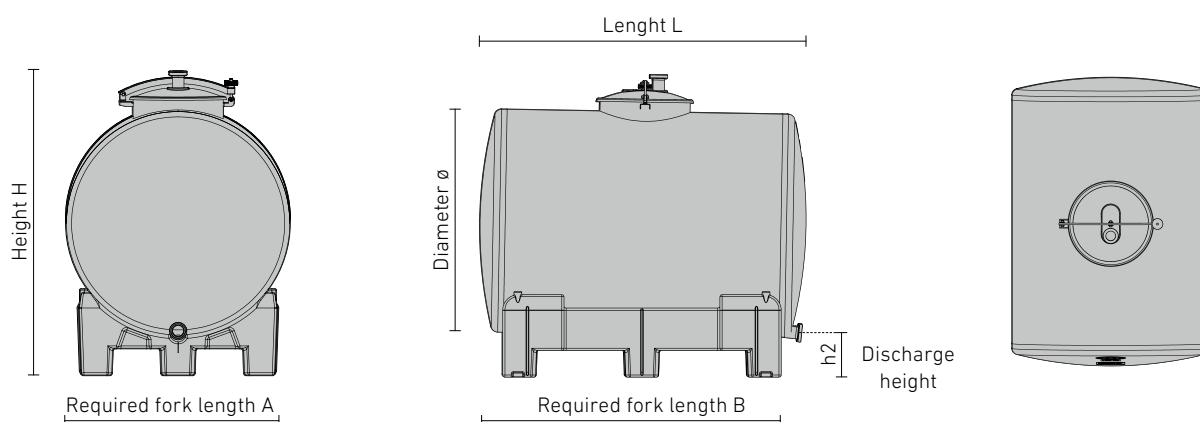

Capacity	L	ø	H	h2	A / B	Order No.
liter	mm	mm	mm	mm	mm	
1,050	1,463	1,000	1,364	197	875 / 1,335	LD-T-100-1050
1,550	1,510	1,200	1,571	197	1,125 / 1,370	LD-T-120-1550

Storage, transportation and stacking tank ST-T



APPLICATION RANGE (PRESSURELESS)

- Transportation
- Blending
- Stirring
- Mixing
- Storage

Ideal for

- Beverages
- Food
- Plant construction
- Industry

Speidel's ST-T tank for storage, transportation and stacking is truly versatile. Up to three of the tanks can be stacked on one another even when filled. Yet, with the appropriate supplementary equipment they allow even more applications. If ordered for example with mash door and double jacket, the ST-T is ideally suited for the processing of mash.

The stable stainless steel framework is accessible from four sides by forklift / pallet truck. To guarantee even higher safety during transportation by forklift the tanks have additional fork lift receptacles that can be accessed from underneath from two sides. By default, the top end is made of AISI 316 material.

For forklift and pallet
truck transportation





STANDARD EQUIPMENT FOR STORAGE, TRANSPORTATION AND STACKING TANK ST-T

- For non-pressurized use
- Tank shell and tank bottom are made of AISI 304 stainless steel, surface IIIId (2R), marbled outside
- Tank top made of AISI 316 stainless steel, surface IIIId (2R), marbled outside
- Vaulted tank top with lifting lugs
- With filler neck 400 mm, flap lid with outer clamp fastener, with stainless steel vent neck NW 50 DIN 11851 with sealing cap
- Vaulted tank bottom with discharge outlet external thread NW 50 DIN 11851
- With stable stainless steel framework, accessible from four sides by forklift / pallet truck
- Additionally accessible from two sides with forklift receptacles 120 x 60 mm, internal dimension shape 114 x 54 mm
- Stackable a maximum of three filled tanks

DIMENSIONS OF STORAGE, TRANSPORTATION AND STACKING TANK ST-T

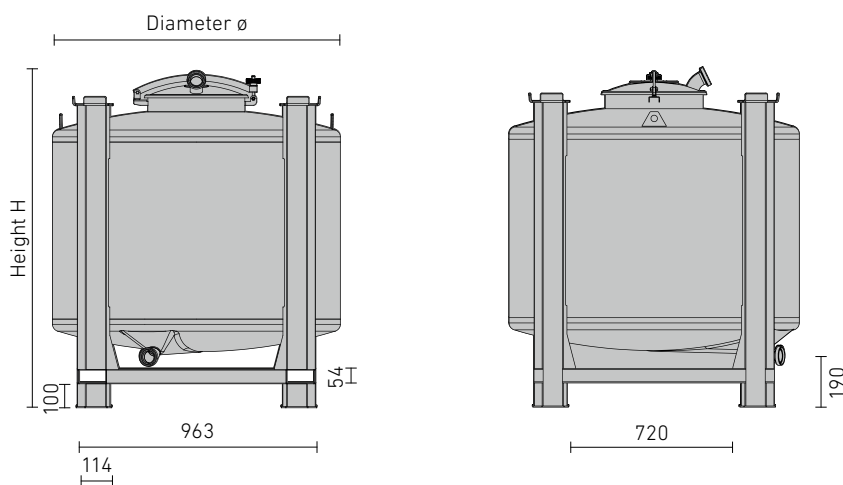

Please pay attention to the internal dimensions of the forklift profiles

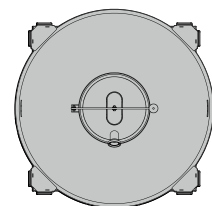

Capacity	\varnothing Tank	H	Order No.
liter	mm	mm	
1,000	1,200	1,435	ST-T-120-1000

Distilling mash tank FD-B



For high quality distilleries the mash tank FD-B is a must-have. In order to turn fine fruits into fine liquor, the mash needs to be processed professionally. This is where Speidel comes into play, because good mash simply needs a good tank.

The tank's plastic base for transportation and storage guarantees the tank's easy and safe handling. Due to the base the tank is, of course, accessible from underneath by forklift / pallet truck.

APPLICATION RANGE (PRESSURELESS)

- Storage
- Transport
- Maturation

Ideal for

- Mash
- Wine
- Must
- Spirits

For forklift and pallet
truck transportation





STANDARD EQUIPMENT FOR DISTILLING MASH TANK FD-B

- For non-pressurized use
- AISI304 stainless steel, surface IIIId (2R), marbled outside
- With lifting lugs
- Vaulted, stable tank top with filler neck NW 400 mm
- Up to tank- ϕ of 820 mm arranged in the centre of the tank top

- From tank- ϕ of 1,000 mm upwards arranged up-front in tank top
- Flap lid with outer clamp fastener, stainless steel vent neck AGG 1 1/2" (BSP) with sealing cap to hold fermentation lock and bung

Bottom outlet

- Discharge neck NW 65 with outlet external thread G 2 1/2" (BSP)
- PE-transportation and storage base, accessible by forklift / pallet truck

DIMENSIONS OF DISTILLING MASH TANK FD-B

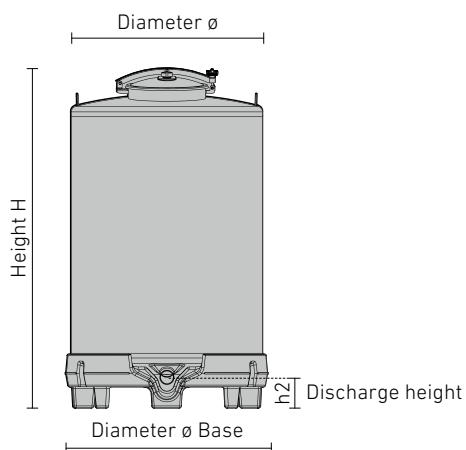

Capacity	ϕ Tank	ϕ Base	H	h2	Order No.
liter	mm	mm	mm	mm	
525	820	873	1,440	160	FD-B-082-0525
625	820	873	1,635	160	FD-B-082-0625
750	820	873	1,898	160	FD-B-082-0750
1,050	1,000	1,054	1,810	135	FD-B-100-1050
1,850	1,200	1,256	2,075	115	FD-B-120-1850

Mash storage tank FD-MBT



Speidel's upright mash storage tank serves for the interim storage of fruit and grape mash in between the delivery and the processing of the mash. In addition, the FD-MBT can also be used as processing tank for the treatment with enzymes of liquid fruit mashes.

The robust stirring device allows for the mash to be constantly moved and homogenised. A stainless steel remover arm with scrapers made of vulkollan ensures the automatic release. This allows the complete release of the material/content.

APPLICATION RANGE (PRESSURELESS)

- Stockage
- Mixing
- Stirring
- Storage

Ideal for

- Fruit mash
- Wine mash
- Distilling mash

further applications
on request

For the storage of grape mash
or liquid fruit mash





STANDARD EQUIPMENT FOR MASH STORAGE TANK FD-MBT

- For non-pressurized use

Tank top

- Up to tank- \varnothing 2,000 mm made of AISI 316 stainless steel, surface IIIId (2R), marbled outside
- From tank- \varnothing 2,200 mm upwards made of AISI 316 stainless steel, surface IIIId (2R) / IIIc (2B)
- Ladder safety bow, lifting lugs

Tank shell

- Made of AISI 304 stainless steel, surface IIIId (2R), marbled outside

Tank bottom

- Up to tank- \varnothing of 2,000 mm made of AISI 304 stainless steel, surface IIIId (2R), marbled outside
- From tank- \varnothing of 2,200 mm upwards made of AISI 304 stainless steel, surface IIIId (2R) / IIIc (2B)
- Free-standing on welded-on box-shaped legs

Filler neck

- Filler neck NW 400, located in tank top with an upright forward position (tank top with bead extrusion for complete ventilation)
- Flap lid with vent neck NW 50 Rd 78 x 1/6"

Stirring device / Regulation

- Stable stirring shaft, stirring blades for the homogenisation and release of the mash
- Electronic control system (stainless steel control cabinet, by default arranged on right), On / Off, connection 380 V, 50 Hz, IP 44
- Stainless steel remover with scraper made of vulkollan (polyurethan) with gear motor (approx. 8 rpm), power output 3 kW up to \varnothing 2,400 mm, electric connection on site
- Stainless steel remover with scraper made of vulkollan with gear motor (approx. 8 rpm), power output 5,5 kW at \varnothing 2,800 mm, electric connection on site

Manhole

- 420 x 320 mm, door with bow and hand wheel with electric fuse







Racking outlet

- Reinforcing plate with drilled hole \varnothing 48 mm to hold flap valve Gr. 37 or weld-on thread NW 50 DIN 11851

Mash outlet

- Welded-on neck with thread NW 125
- Discharge height X = 420 mm

SET-UP EXAMPLE FOR MASH STORAGE TANK FD-MBT

Item	Order No.
	<p>Mash storage tank FD-MBT-240-15500</p> <ul style="list-style-type: none"> · h = 4,570 mm, H = 4,870mm, · $H_{\text{compl.}} = 4,870 \text{ mm (H)} + \text{approx. } 150 \text{ mm (cleaning pipe)}$ · + approx. 100 mm (height compensation) = approx. 5,120 mm · Standard equipment as on page 79 <p style="text-align: right;">FD-MBT-240-15500</p>
	<p>Racking outlet (page 172)</p> <ul style="list-style-type: none"> · With mounted flap valve Gr. 37 <p style="text-align: right;">KA-120I</p>
	<p>Mash outlet (page 172)</p> <ul style="list-style-type: none"> · With ball valve NW 125 DIN 11851 <p style="text-align: right;">65684</p>
	<p>Automatic temperature regulation with target indicator and actual indicator (page 192)</p> <ul style="list-style-type: none"> · Mash heating / cooling via local warm water / cold water source is automatically regulated according to target value input by the control system via magnet valve <p style="text-align: right;">DMS-1</p>
	<p>Heating and cooling jacket (page 128)</p> <ul style="list-style-type: none"> · Double jacket B7 9.2 m² with welded gland thread G 1" for connection to available warm water / cold water source · Version 1, layout 33, connection position B7 <p style="text-align: right;">1B7</p>
	<p>Adjustable feet (page 184)</p> <ul style="list-style-type: none"> · With adjustable feet for tank legs (approx. 100 mm) <p style="text-align: right;">46129</p>

DIMENSIONS OF MASH STORAGE TANK FD-MBT

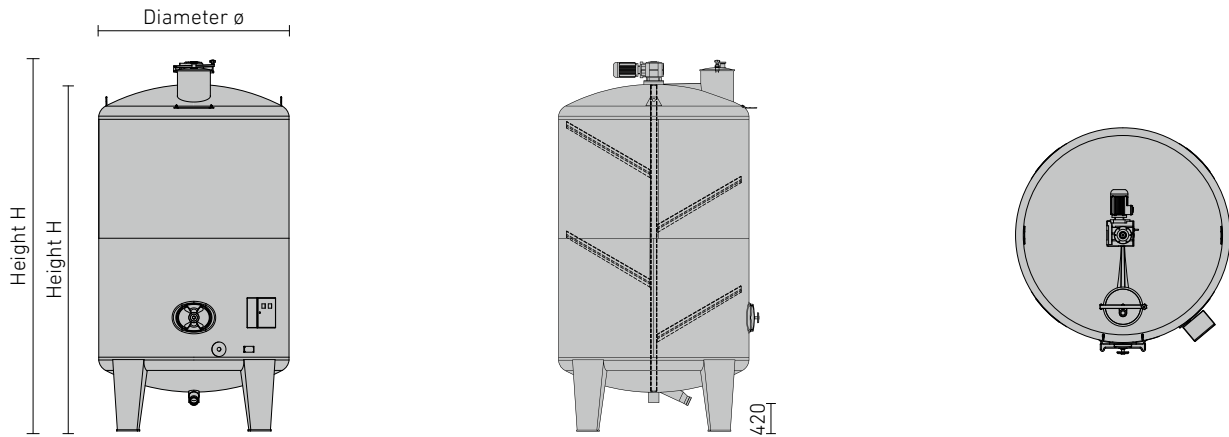

Capacity liter	ø mm	h mm	H mm	Stirring device wing pieces	Legs pieces	Order No.
5,200	2,000	2,608	2,948	2	3	FD-MBT-200- 5200
6,000	2,000	2,858	3,198	4	3	FD-MBT-200- 6000
6,700	2,000	3,096	3,436	4	3	FD-MBT-200- 6700
7,500	2,000	3,346	3,686	4	3	FD-MBT-200- 7500
8,300	2,000	3,596	3,936	4	3	FD-MBT-200- 8300
9,200	2,000	3,846	4,186	5	3	FD-MBT-200- 9200
9,800	2,000	4,096	4,436	5	3	FD-MBT-200- 9800
10,600	2,000	4,346	4,686	5	3	FD-MBT-200-10600
10,000	2,400	3,320	3,620	4	4	FD-MBT-240-10000
11,200	2,400	3,570	3,870	4	4	FD-MBT-240-11200
12,300	2,400	3,820	4,120	4	4	FD-MBT-240-12200
13,500	2,400	4,070	4,370	4	4	FD-MBT-240-13500
14,500	2,400	4,320	4,620	5	4	FD-MBT-240-14500
15,500	2,400	4,570	4,870	5	4	FD-MBT-240-15500
16,500	2,400	4,820	5,120	6	4	FD-MBT-240-16500
18,000	2,400	5,070	5,370	6	4	FD-MBT-240-18000
19,000	2,400	5,320	5,620	6	4	FD-MBT-240-19000
20,000	2,400	5,570	5,870	6	4	FD-MBT-240-20000
17,000	2,800	3,920	4,270	4	4	FD-MBT-280-17000
18,500	2,800	4,170	4,520	4	4	FD-MBT-280-18500
20,000	2,800	4,420	4,770	4	4	FD-MBT-280-20000
21,500	2,800	4,670	5,020	5	4	FD-MBT-280-21500
23,000	2,800	4,920	5,270	6	4	FD-MBT-280-23000
24,500	2,800	5,170	5,520	6	4	FD-MBT-280-24500
26,000	2,800	5,420	5,770	6	4	FD-MBT-280-26000
27,500	2,800	5,670	6,020	6	4	FD-MBT-280-27500
29,400	2,800	5,920	6,270	6	4	FD-MBT-280-29400

Version with conical bottom
available



Pressure tanks







KZE-tank KZE Concentrate storage tank KZEK

The short-time heating (KZE) is a successful method for the preservation of fruit and vegetable juices. During the heating, the liquid is heated up to a temperature of about 70–80 °C and the temperature is maintained for a few seconds. After the cooling, the juice is stored in sterilised KZE-tanks. The extremely short heating largely maintains the juice's aroma, vitamins and ingredients.

The storage in the tanks is carried out through the blanketing with sterile air or nitrogen.

The KZE-tank is suited for the storage of juices with a maximum density of 1.1 kg / dm³ at an operating pressure up to 0.5 bar for the blanketing with nitrogen or sterile air. For the optimal storage of the concentrate in pressureless conditions use the KZEK-tank.

APPLICATION RANGE
(PRESSURE RANGE UP TO 0,5 BAR
+ PRESSURELESS)

· Storage

Ideal for

- Fruit juice
- Vegetable juice

Welded manhole with swivelling handle, for steaming as sterile tank and processing tank





STANDARD EQUIPMENT FOR KZE / KZEK-TANK

- KZE-Tank for pressure applications up to 0,5 bar with a density of 1,1
- KZEK tank for non-pressurized use at a density of 1.37 or 0.5 bar at density 1.1
- Tank top made of stainless steel AISI 304 (V2A), surface III d / III c
- Tank shells made of stainless steel AISI 304 (V2A), surface III d / III c
- Tank bottom made of stainless steel AISI 304 (V2A), surface III d / III c
- Vaulted dimensionally stable tank top with lifting lugs and ladder safety bar
- Free-standing on welded-on legs – perfect stability and force transmission into the tank shell

Sampling

- Weld-on thread NW 20 DIN 11851

Manhole

- Welded stable manhole neck 340 x 440 mm LW
- Door with swivelling handle and toggle nut

Racking outlet

- Reinforcing plate with drilled hole \varnothing 48 mm for weld-on thread NW 40 or NW 50 DIN 11851

Bottom outlet

- Vaulted, stable tank bottom, in bottom centre with forward drawn discharge pipe and outlet with thread NW 50 DIN 11851

DIMENSIONS OF KZE-TANK / CONCENTRATE STORAGE TANK KZEK

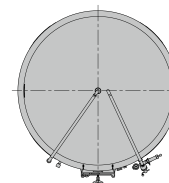
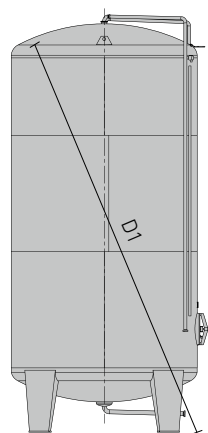
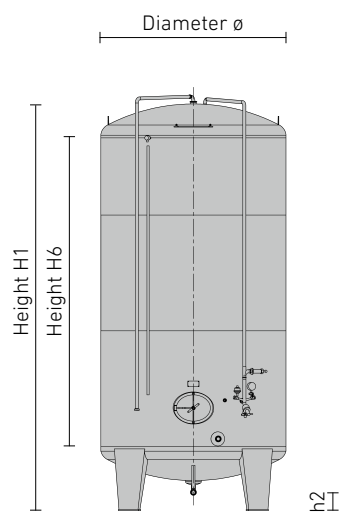
**Legend**

h1 = Tank height
 h2 = Discharge height
 h6 = Shell height
 D1 = Installation height

KZE-TANK / CONCENTRATE STORAGE TANK KZEK Ø 1,600 MM

Capacity liter	ø mm	h1 mm	h2 mm	h6 mm	D1 mm	Order No. KZE		Order No. KZEK	
						0.5 bar, density 1.1		0.5 bar, density 1.1 or 0.0 bar, density 1.37	
2,600	1,600	2,007	255	1,000	2,420	KZE-160-02600	8xM20	KZEK-160-02600	8xM20
3,100	1,600	2,257	255	1,250	2,575	KZE-160-03100	8xM20	KZEK-160-03100	8xM20
3,600	1,600	2,507	255	1,500	2,760	KZE-160-03600	8xM20	KZEK-160-03600	8xM20
4,100	1,600	2,757	255	1,750	2,970	KZE-160-04100	8xM20	KZEK-160-04100	8xM20
4,500	1,600	3,007	255	2,000	3,190	KZE-160-04500	8xM20	KZEK-160-04500	8xM20
5,000	1,600	3,257	255	2,250	3,420	KZE-160-05000	8xM20	KZEK-160-05000	8xM20
5,500	1,600	3,507	255	2,500	3,655	KZE-160-05500	8xM20	KZEK-160-05500	8xM20
6,000	1,600	3,757	255	2,750	3,890	KZE-160-06000	8xM20	KZEK-160-06000	8xM20
6,500	1,600	4,007	255	3,000	4,130	KZE-160-06500	8xM20	KZEK-160-06500	8xM20
7,000	1,600	4,257	255	3,250	4,375	KZE-160-07000	8xM20	KZEK-160-07000	8xM20
7,500	1,600	4,507	255	3,500	4,620	KZE-160-07500	8xM20	KZEK-160-07500	8xM20
8,000	1,600	4,757	255	3,750	4,860	KZE-160-08000	8xM20	KZEK-160-08000	8xM20
8,500	1,600	5,007	255	4,000	5,110	KZE-160-08500	8xM20	KZEK-160-08500	8xM20
9,000	1,600	5,257	255	4,250	5,355	KZE-160-09000	8xM20	KZEK-160-09000	8xM20
9,500	1,600	5,507	255	4,500	5,600	KZE-160-09500	8xM20	KZEK-160-09500	8xM20
10,000	1,600	5,757	255	4,750	5,855	KZE-160-10000	8xM20	KZEK-160-10000	8xM20



KZE-TANK / CONCENTRATE STORAGE TANK KZEK Ø 1,800 MM

Capacity	ø	h1	h2	h6	D1	Order No.	HV	Order No.	HV
						KZE	KZE	KZEK	KZEK
liter	mm	mm	mm	mm	mm	0.5 bar, density 1.1		0.5 bar, density 1.1 or 0.0 bar, density 1.37	
3,500	1,800	2,137	255	1,000	2,525	KZE-180-03500	8 x M24	KZEK-180-03500	8 x M24
4,200	1,800	2,387	255	1,250	2,725	KZE-180-04200	8 x M24	KZEK-180-04200	8 x M24
4,800	1,800	2,637	255	1,500	2,930	KZE-180-04800	8 x M24	KZEK-180-04800	8 x M24
5,400	1,800	2,887	255	1,750	3,150	KZE-180-05400	8 x M24	KZEK-180-05400	8 x M24
6,000	1,800	3,137	255	2,000	3,365	KZE-180-06000	8 x M24	KZEK-180-06000	8 x M24
6,700	1,800	3,387	255	2,250	3,585	KZE-180-06700	8 x M24	KZEK-180-06700	8 x M24
7,300	1,800	3,637	255	2,500	3,815	KZE-180-07300	8 x M24	KZEK-180-07300	8 x M24
7,900	1,800	3,887	255	2,750	4,050	KZE-180-07900	8 x M24	KZEK-180-07900	8 x M24
8,500	1,800	4,137	255	3,000	4,285	KZE-180-08500	8 x M24	KZEK-180-08500	8 x M24
9,100	1,800	4,387	255	3,250	4,525	KZE-180-09100	8 x M24	KZEK-180-09100	8 x M24
9,800	1,800	4,637	255	3,500	4,765	KZE-180-09800	8 x M24	KZEK-180-09800	8 x M24
10,400	1,800	4,887	255	3,750	5,010	KZE-180-10400	8 x M24	KZEK-180-10400	8 x M24
11,000	1,800	5,137	255	4,000	5,250	KZE-180-11000	8 x M24	KZEK-180-11000	8 x M24
11,600	1,800	5,387	255	4,250	5,495	KZE-180-11600	8 x M24	KZEK-180-11600	8 x M24
12,200	1,800	5,637	255	4,500	5,740	KZE-180-12200	8 x M24	KZEK-180-12200	8 x M24
12,800	1,800	5,887	255	4,750	5,990	KZE-180-12800	8 x M24	KZEK-180-12800	8 x M24
13,500	1,800	6,137	255	5,000	6,235	KZE-180-13500	8 x M24	KZEK-180-13500	8 x M24
14,000	1,800	6,387	255	5,250	6,485	KZE-180-14000	8 x M24	KZEK-180-14000	8 x M24
14,600	1,800	6,637	255	5,500	6,735	KZE-180-14600	8 x M24	KZEK-180-14600	8 x M24

KZE-TANK / CONCENTRATE STORAGE TANK KZEK Ø 2,000 MM

Capacity	ø	h1	h2	h6	D1	Order No.	HV	Order No.	HV
						KZE	KZE	KZEK	KZEK
liter	mm	mm	mm	mm	mm	0,5 bar, density 1.1		0,5 bar, density 1.1 or 0,0 bar, density 1.37	
4,400	2,000	2,140	255	1,000	2,620	KZE-200-04400	8 x M24	KZEK-200-04400	8 x M24
5,200	2,000	2,390	255	1,250	2,810	KZE-200-05200	8 x M24	KZEK-200-05200	8 x M24
6,000	2,000	2,640	255	1,500	3,010	KZE-200-06000	8 x M24	KZEK-200-06000	8 x M24
6,700	2,000	2,890	255	1,750	3,230	KZE-200-06700	8 x M24	KZEK-200-06700	8 x M24
7,500	2,000	3,140	255	2,000	3,430	KZE-200-07500	8 x M24	KZEK-200-07500	8 x M24
8,300	2,000	3,390	255	2,250	3,640	KZE-200-08300	8 x M24	KZEK-200-08300	8 x M24
9,000	2,000	3,640	255	2,500	3,860	KZE-200-09000	8 x M24	KZEK-200-09000	8 x M24
9,800	2,000	3,890	255	2,750	4,090	KZE-200-09800	8 x M24	KZEK-200-09800	8 x M24
10,600	2,000	4,140	255	3,000	4,320	KZE-200-10600	8 x M24	KZEK-200-10600	8 x M24
11,300	2,000	4,390	255	3,250	4,555	KZE-200-11300	8 x M24	KZEK-200-11300	8 x M24
12,000	2,000	4,640	255	3,500	4,795	KZE-200-12000	8 x M24	KZEK-200-12000	8 x M24
12,800	2,000	4,890	255	3,750	5,035	KZE-200-12800	8 x M24	KZEK-200-12800	8 x M24
13,600	2,000	5,140	255	4,000	5,280	KZE-200-13600	8 x M24	KZEK-200-13600	8 x M24
14,400	2,000	5,390	255	4,250	5,520	KZE-200-14400	8 x M24	KZEK-200-14400	8 x M24
15,200	2,000	5,640	255	4,500	5,760	KZE-200-15200	8 x M24	KZEK-200-15200	8 x M24
16,000	2,000	5,890	255	4,750	6,010	KZE-200-16000	8 x M24	KZEK-200-16000	8 x M24
16,700	2,000	6,140	255	5,000	6,250	KZE-200-16700	8 x M24	KZEK-200-16700	8 x M24
17,500	2,000	6,390	255	5,250	6,495	KZE-200-17500	8 x M30	KZEK-200-17500	8 x M30
18,200	2,000	6,640	255	5,500	6,750	KZE-200-18200	8 x M30	KZEK-200-18200	8 x M30
19,000	2,000	6,890	255	5,750	6,995	KZE-200-19000	8 x M30	KZEK-200-19000	8 x M30
19,900	2,000	7,140	255	6,000	7,245	KZE-200-19900	8 x M30	KZEK-200-19900	8 x M30
20,500	2,000	7,390	255	6,250	7,495	KZE-200-20500	8 x M30	KZEK-200-20500	8 x M30

KZE-TANK / CONCENTRATE STORAGE TANK KZEK Ø 2,200 MM

Capacity	ø	h1	h2	h6	D1	Order No.	HV	Order No.	HV
						KZE	KZE	KZEK	KZEK
liter	mm	mm	mm	mm	mm	0.5 bar, density 1.1		0,5 bar, density 1.1 or 0,0 bar, density 1.37	
7,500	2,200	2,690	255	1,500	3,130	KZE-220-07500	8 x M24	KZEK-220-07500	8 x M24
8,400	2,200	2,940	255	1,750	3,330	KZE-220-08400	8 x M24	KZEK-220-08400	8 x M24
9,200	2,200	3,190	255	2,000	3,536	KZE-220-09200	8 x M24	KZEK-220-09200	8 x M24
10,200	2,200	3,440	255	2,250	3,750	KZE-220-10200	8 x M24	KZEK-220-10200	8 x M24
11,000	2,200	3,690	255	2,500	3,965	KZE-220-11000	8 x M24	KZEK-220-11000	8 x M24
12,000	2,200	3,940	255	2,750	4,185	KZE-220-12000	8 x M24	KZEK-220-12000	8 x M24
13,000	2,200	4,190	255	3,000	4,410	KZE-220-13000	8 x M24	KZEK-220-13000	8 x M24
14,000	2,200	4,440	255	3,250	4,640	KZE-220-14000	8 x M24	KZEK-220-14000	8 x M24
15,000	2,200	4,690	255	3,500	4,875	KZE-220-15000	8 x M24	KZEK-220-15000	8 x M24
16,000	2,200	4,940	255	3,750	5,110	KZE-220-16000	8 x M24	KZEK-220-16000	8 x M24
16,800	2,200	5,190	255	4,000	5,350	KZE-220-16800	8 x M24	KZEK-220-16800	8 x M24
17,500	2,200	5,440	255	4,250	5,590	KZE-220-17500	8 x M24	KZEK-220-17500	8 x M24
18,500	2,200	5,690	255	4,500	5,830	KZE-220-18500	8 x M24	KZEK-220-18500	8 x M24
19,500	2,200	5,940	255	4,750	6,075	KZE-220-19500	8 x M24	KZEK-220-19500	8 x M24
20,500	2,200	6,190	255	5,000	6,320	KZE-220-20500	8 x M30	KZEK-220-20500	8 x M30
21,500	2,200	6,440	255	5,250	6,560	KZE-220-21500	8 x M30	KZEK-220-21500	8 x M30
22,500	2,200	6,690	255	5,500	6,810	KZE-220-22500	8 x M30	KZEK-220-22500	8 x M30
23,500	2,200	6,940	255	5,750	7,055	KZE-220-23500	8 x M30	KZEK-220-23500	8 x M30
24,500	2,200	7,190	255	6,000	7,300	KZE-220-24500	8 x M30	KZEK-220-24500	8 x M30
25,000	2,200	7,440	255	6,250	7,545	KZE-220-25000	8 x M30	KZEK-220-25000	8 x M30

KZE-TANK / CONCENTRATE STORAGE TANK KZEK Ø 2,400 MM

Capacity	ø	h1	h2	h6	D1	Order No.	HV	Order No.	HV
						KZE	KZE	KZEK	KZEK
liter	mm	mm	mm	mm	mm	0.5 bar, density 1.1		0.5 bar, density 1.1 or 0.0 bar, density 1.37	
8,900	2,400	2,770	255	1,500	3,285	KZE-240-08900	8 x M24	KZEK-240-08900	8 x M24
10,000	2,400	3,020	255	1,750	3,480	KZE-240-10000	8 x M24	KZEK-240-10000	8 x M24
11,200	2,400	3,270	255	2,000	3,680	KZE-240-11200	8 x M24	KZEK-240-11200	8 x M24
12,300	2,400	3,520	255	2,250	3,890	KZE-240-12300	8 x M24	KZEK-240-12300	8 x M24
13,400	2,400	3,770	255	2,500	4,100	KZE-240-13400	8 x M24	KZEK-240-13400	8 x M24
14,500	2,400	4,020	255	2,750	4,320	KZE-240-14500	8 x M24	KZEK-240-14500	8 x M24
15,500	2,400	4,270	255	3,000	4,540	KZE-240-15500	8 x M24	KZEK-240-15500	8 x M24
16,500	2,400	4,520	255	3,250	4,765	KZE-240-16500	8 x M24	KZEK-240-16500	8 x M24
17,900	2,400	4,770	255	3,500	4,990	KZE-240-17900	8 x M24	KZEK-240-17900	8 x M24
19,000	2,400	5,020	255	3,750	5,225	KZE-240-19000	8 x M24	KZEK-240-19000	8 x M24
20,000	2,400	5,270	255	4,000	5,460	KZE-240-20000	8 x M24	KZEK-240-20000	8 x M24
21,000	2,400	5,520	255	4,250	5,700	KZE-240-21000	8 x M30	KZEK-240-21000	8 x M30
22,400	2,400	5,770	255	4,500	5,940	KZE-240-22400	8 x M30	KZEK-240-22400	8 x M30
23,500	2,400	6,020	255	4,750	6,180	KZE-240-23500	8 x M30	KZEK-240-23500	8 x M30
24,500	2,400	6,270	255	5,000	6,420	KZE-240-24500	8 x M30	KZEK-240-24500	8 x M30
25,500	2,400	6,520	255	5,250	6,665	KZE-240-25500	10 x M30	KZEK-240-25500	10 x M30
26,800	2,400	6,770	255	5,500	6,905	KZE-240-26800	10 x M30	KZEK-240-26800	10 x M30
28,000	2,400	7,020	255	5,750	7,150	KZE-240-28000	10 x M30	KZEK-240-28000	10 x M30
29,000	2,400	7,270	255	6,000	7,395	KZE-240-29000	10 x M30	KZEK-240-29000	10 x M30
30,000	2,400	7,520	255	6,250	7,640	KZE-240-30000	10 x M30	KZEK-240-30000	10 x M30

KZE-TANK / CONCENTRATE STORAGE TANK KZEK Ø 2,600 MM

Capacity	ø	h1	h2	h6	D1	Order No.	HV	Order No.	HV
						KZE	KZE	KZEK	KZEK
liter	mm	mm	mm	mm	mm	0.5 bar, density 1.1		0.5 bar, density 1.1 or 0.0 bar, density 1.37	
10,800	2,600	2,860	255	1,500	3,480	KZE-260-10800	8xM24	KZEK-260-10800	8xM24
12,200	2,600	3,110	255	1,750	3,670	KZE-260-12200	8xM24	KZEK-260-12200	8xM24
13,500	2,600	3,360	255	2,000	3,865	KZE-260-13500	8xM24	KZEK-260-13500	8xM24
14,500	2,600	3,610	255	2,250	4,070	KZE-260-14500	8xM24	KZEK-260-14500	8xM24
16,000	2,600	3,860	255	2,500	4,280	KZE-260-16000	8xM24	KZEK-260-16000	8xM24
17,300	2,600	4,110	255	2,750	4,490	KZE-260-17300	8xM24	KZEK-260-17300	8xM24
18,500	2,600	4,360	255	3,000	4,710	KZE-260-18500	8xM24	KZEK-260-18500	8xM24
20,000	2,600	4,610	255	3,250	4,930	KZE-260-20000	8xM24	KZEK-260-20000	8xM24
21,300	2,600	4,860	255	3,500	5,150	KZE-260-21300	8xM30	KZEK-260-21300	8xM30
22,500	2,600	5,110	255	3,750	5,375	KZE-260-22500	8xM30	KZEK-260-22500	8xM30
24,000	2,600	5,360	255	4,000	5,610	KZE-260-24000	8xM30	KZEK-260-24000	8xM30
25,300	2,600	5,610	255	4,250	5,845	KZE-260-25300	8xM30	KZEK-260-25300	8xM30
26,500	2,600	5,860	255	4,500	6,080	KZE-260-26500	10xM30	KZEK-260-26500	10xM30
28,000	2,600	6,110	255	4,750	6,320	KZE-260-28000	10xM30	KZEK-260-28000	10xM30
29,000	2,600	6,360	255	5,000	6,560	KZE-260-29000	10xM30	KZEK-260-29000	10xM30
30,500	2,600	6,610	255	5,250	6,800	KZE-260-30500	10xM30	KZEK-260-30500	10xM30
32,000	2,600	6,860	255	5,500	7,040	KZE-260-32000	10xM30	KZEK-260-32000	10xM30
33,000	2,600	7,110	255	5,750	7,290	KZE-260-33000	10xM30	KZEK-260-33000	10xM30
34,500	2,600	7,360	255	6,000	7,530	KZE-260-34500	10xM30	KZEK-260-34500	10xM30
36,000	2,600	7,665	255	6,250	7,830	KZE-260-36000	10xM30	KZEK-260-36000	10xM30
37,000	2,600	7,915	255	6,500	8,075	KZE-260-37000	10xM30	KZEK-260-37000	10xM30
38,500	2,600	8,165	255	6,750	8,320	KZE-260-38500	10xM30	KZEK-260-38500	10xM30
40,000	2,600	8,415	255	7,000	8,565	KZE-260-40000	10xM30	KZEK-260-40000	10xM30

KZE-TANK / CONCENTRATE STORAGE TANK KZEK Ø 2,800 MM

Capacity	ø	h1	h2	h6	D1	Order No.	HV	Order No.	HV
						KZE	KZE	KZEK	KZEK
liter	mm	mm	mm	mm	mm	0.5 bar, density 1.1		0.5 bar, density 1.1 or 0.0 bar, density 1.37	
12,500	2,800	2,890	255	1,500	3,630	KZE-280-12500	8xM24	KZEK-280-12500	8xM24
14,000	2,800	3,140	255	1,750	3,815	KZE-280-14000	8xM24	KZEK-280-14000	8xM24
15,500	2,800	3,390	255	2,000	4,005	KZE-280-15500	8xM24	KZEK-280-15500	8xM24
17,000	2,800	3,640	255	2,250	4,205	KZE-280-17000	8xM24	KZEK-280-17000	8xM24
18,500	2,800	3,890	255	2,500	4,405	KZE-280-18500	8xM24	KZEK-280-18500	8xM24
20,000	2,800	4,140	255	2,750	4,615	KZE-280-20000	8xM24	KZEK-280-20000	8xM24
21,500	2,800	4,390	255	3,000	4,830	KZE-280-21500	8xM24	KZEK-280-21500	8xM24
23,000	2,800	4,640	255	3,250	5,045	KZE-280-23000	8xM30	KZEK-280-23000	8xM30
24,500	2,800	4,890	255	3,500	5,265	KZE-280-24500	8xM30	KZEK-280-24500	8xM30
26,000	2,800	5,140	255	3,750	5,485	KZE-280-26000	8xM30	KZEK-280-26000	8xM30
27,500	2,800	5,390	255	4,000	5,710	KZE-280-27500	8xM30	KZEK-280-27500	8xM30
29,300	2,800	5,640	255	4,250	5,940	KZE-280-29300	8xM30	KZEK-280-29300	8xM30
31,000	2,800	5,985	255	4,500	6,265	KZE-280-31000	10xM30	KZEK-280-31000	10xM30
32,500	2,800	6,235	255	4,750	6,495	KZE-280-32500	10xM30	KZEK-280-32500	10xM30
34,000	2,800	6,485	255	5,000	6,730	KZE-280-34000	10xM30	KZEK-280-34000	10xM30
35,500	2,800	6,735	255	5,250	6,965	KZE-280-35500	10xM30	KZEK-280-35500	10xM30
37,000	2,800	6,985	255	5,500	7,205	KZE-280-37000	10xM30	KZEK-280-37000	10xM30
38,500	2,800	7,235	255	5,750	7,445	KZE-280-38500	10xM30	KZEK-280-38500	10xM30
40,000	2,800	7,485	255	6,000	7,715	KZE-280-40000	10xM30	KZEK-280-40000	10xM30
42,000	2,800	7,735	255	6,250	7,955	KZE-280-42000	10xM30	KZEK-280-42000	10xM30
43,500	2,800	7,985	255	6,500	8,195	KZE-280-43500	10xM30	KZEK-280-43500	10xM30
45,000	2,800	8,235	255	6,750	8,440	KZE-280-45000	10xM30	KZEK-280-45000	12xM30

KZE-TANK / CONCENTRATE STORAGE TANK KZEK Ø 3,000 MM

Capacity	Ø	h1	h2	h6	D1	Order No.	HV	Order No.	HV
						KZE	KZE	KZEK	KZEK
liter	mm	mm	mm	mm	mm	0.5 bar, density 1.1		0.5 bar, density 1.1 or 0.0 bar, density 1.37	
12,500	3,000	2,630	255	1,000	3,510	KZE-300-15000	8 x M30	KZEK-300-15000	8 x M30
14,000	3,000	2,880	255	1,250	3,675	KZE-300-14000	8 x M30	KZEK-300-14000	8 x M30
16,000	3,000	3,130	255	1,500	3,855	KZE-300-16000	8 x M30	KZEK-300-16000	8 x M30
17,000	3,000	3,380	255	1,750	4,040	KZE-300-17000	8 x M30	KZEK-300-17000	8 x M30
19,500	3,000	3,630	255	2,000	4,230	KZE-300-19500	8 x M30	KZEK-300-19500	8 x M30
21,000	3,000	3,880	255	2,250	4,430	KZE-300-21000	8 x M30	KZEK-300-21000	8 x M30
23,000	3,000	4,130	255	2,500	4,630	KZE-300-23000	8 x M30	KZEK-300-23000	8 x M30
24,500	3,000	4,380	255	2,750	4,840	KZE-300-24500	8 x M30	KZEK-300-24500	8 x M30
26,500	3,000	4,630	255	3,000	5,050	KZE-300-26500	8 x M30	KZEK-300-26500	8 x M30
28,000	3,000	4,880	255	3,250	5,270	KZE-300-28000	8 x M30	KZEK-300-28000	8 x M30
30,000	3,000	5,130	255	3,500	5,490	KZE-300-30000	8 x M30	KZEK-300-30000	8 x M30
31,500	3,000	5,380	255	3,750	5,710	KZE-300-31500	8 x M30	KZEK-300-31500	10 x M30
33,500	3,000	5,630	255	4,000	5,935	KZE-300-33500	8 x M30	KZEK-300-33500	10 x M30
35,000	3,000	5,880	255	4,250	6,160	KZE-300-35000	10 x M30	KZEK-300-35000	10 x M30
37,000	3,000	6,130	255	4,500	6,390	KZE-300-37000	10 x M30	KZEK-300-37000	10 x M30
38,500	3,000	6,380	255	4,750	6,625	KZE-300-38500	10 x M30	KZEK-300-38500	10 x M30
40,500	3,000	6,630	255	5,000	6,860	KZE-300-40500	10 x M30	KZEK-300-40500	10 x M30
42,000	3,000	6,880	255	5,250	7,095	KZE-300-42000	12 x M30	KZEK-300-42000	12 x M30
44,000	3,000	7,130	255	5,500	7,335	KZE-300-44000	12 x M30	KZEK-300-44000	12 x M30
45,500	3,000	7,380	255	5,750	7,575	KZE-300-45500	12 x M30	KZEK-300-45500	12 x M30
47,500	3,000	7,630	255	6,000	7,815	KZE-300-47500	12 x M30	KZEK-300-47500	12 x M30
49,000	3,000	7,880	255	6,250	8,060	KZE-300-49000	12 x M30	KZEK-300-49000	12 x M30



KZE-TANK / CONCENTRATE STORAGE TANK KZEK Ø 3,200 MM

Capacity	ø	h1	h2	h6	D1	Order No.	HV	Order No.	HV
						KZE	KZE	KZEK	KZEK
	liter	mm	mm	mm	mm	0.5 bar, density 1.1		0.5 bar, density 1.1 or 0.0 bar, density 1.37	
18,800	3,200	3,170	255	1,500	4,050	KZE-320-18000	8 x M30	KZEK-320-18000	8 x M30
20,500	3,200	3,420	255	1,750	4,235	KZE-320-20500	8 x M30	KZEK-320-20500	8 x M30
22,500	3,200	3,670	255	2,000	4,425	KZE-320-22500	8 x M30	KZEK-320-22500	8 x M30
24,500	3,200	3,920	255	2,250	4,620	KZE-320-24500	8 x M30	KZEK-320-24500	8 x M30
26,500	3,200	4,170	255	2,500	4,820	KZE-320-26500	8 x M30	KZEK-320-26500	8 x M30
28,500	3,200	4,420	255	2,750	5,025	KZE-320-28500	8 x M30	KZEK-320-28500	8 x M30
30,500	3,200	4,670	255	3,000	5,235	KZE-320-30500	8 x M30	KZEK-320-30500	8 x M30
32,500	3,200	4,920	255	3,250	5,445	KZE-320-32500	8 x M30	KZEK-320-32500	8 x M30
34,500	3,200	5,170	255	3,500	5,725	KZE-320-34500	10 x M30	KZEK-320-34500	10 x M30
36,500	3,200	5,420	255	3,750	5,940	KZE-320-36500	10 x M30	KZEK-320-36500	10 x M30
38,500	3,200	5,670	255	4,000	6,160	KZE-320-38500	10 x M30	KZEK-320-38500	10 x M30
40,500	3,200	5,920	255	4,250	6,385	KZE-320-40500	10 x M30	KZEK-320-40500	10 x M30
42,500	3,200	6,170	255	4,500	6,605	KZE-320-42500	10 x M36	KZEK-320-42500	10 x M36
44,500	3,200	6,420	255	4,750	6,835	KZE-320-44500	10 x M36	KZEK-320-44500	10 x M36
46,500	3,200	6,670	255	5,000	7,060	KZE-320-46500	10 x M36	KZEK-320-46500	10 x M36
48,500	3,200	6,920	255	5,250	7,425	KZE-320-48500	10 x M36	KZEK-320-48500	10 x M36
50,500	3,200	7,170	255	5,500	7,685	KZE-320-50500	10 x M36	KZEK-320-50500	10 x M36
52,500	3,200	7,420	255	5,750	7,920	KZE-320-52500	10 x M36	KZEK-320-52500	10 x M36
54,500	3,200	7,670	255	6,000	8,155	KZE-320-54500	12 x M36	KZEK-320-54500	12 x M36
56,500	3,200	7,920	255	6,250	8,395	KZE-320-56500	12 x M36	KZEK-320-56500	12 x M36
58,500	3,200	8,360	255	6,500	8,630	KZE-320-58500	12 x M36	KZEK-320-58500	12 x M36
60,500	3,200	8,610	255	6,750	8,870	KZE-320-60500	12 x M36	KZEK-320-60500	12 x M36
62,500	3,200	8,860	255	7,000	9,115	KZE-320-62500	12 x M36	KZEK-320-62500	12 x M36
64,000	3,200	9,110	255	7,250	9,355	KZE-320-64000	12 x M36	KZEK-320-64000	12 x M36
66,500	3,200	9,360	255	7,500	9,595	KZE-320-66500	12 x M36	KZEK-320-66500	12 x M36
68,500	3,200	9,615	255	7,750	9,840	KZE-320-68500	12 x M36	KZEK-320-68500	12 x M36



KZE-TANK / CONCENTRATE STORAGE TANK KZEK Ø 3,400 MM

Capacity	ø	h1	h2	h6	D1	Order No.	HV	Order No.	HV
						KZE	KZE	KZEK	KZEK
liter	mm	mm	mm	mm	mm	0.5 bar, density 1.1		0.5 bar, density 1.1 or 0.0 bar, density 1.37	
21,500	3,400	3,260	255	1,500	4,285	KZE-340-21500	10 x M30	KZEK-340-21500	10 x M30
24,000	3,400	3,510	255	1,750	4,455	KZE-340-24000	10 x M30	KZEK-340-24000	10 x M30
26,000	3,400	3,760	255	2,000	4,635	KZE-340-26000	10 x M30	KZEK-340-26000	10 x M30
28,000	3,400	4,010	255	2,250	4,820	KZE-340-28000	10 x M30	KZEK-340-28000	10 x M30
30,500	3,400	4,260	255	2,500	5,010	KZE-340-30500	10 x M30	KZEK-340-30500	10 x M30
33,000	3,400	4,510	255	2,750	5,210	KZE-340-33000	10 x M30	KZEK-340-33000	10 x M30
35,000	3,400	4,760	255	3,000	5,410	KZE-340-35000	10 x M30	KZEK-340-35000	10 x M30
37,500	3,400	5,010	255	3,250	5,615	KZE-340-37500	10 x M30	KZEK-340-37500	10 x M30
39,500	3,400	5,260	255	3,500	5,825	KZE-340-39500	10 x M30	KZEK-340-39500	10 x M36
42,000	3,400	5,490	255	3,750	6,225	KZE-340-42000	10 x M36	KZEK-340-42000	10 x M36
44,000	3,400	5,740	255	4,000	6,440	KZE-340-44000	10 x M36	KZEK-340-44000	10 x M30
46,000	3,400	5,990	255	4,250	6,660	KZE-340-46000	10 x M36	KZEK-340-46000	10 x M36
48,500	3,400	6,240	255	4,500	6,880	KZE-340-48500	10 x M36	KZEK-340-48500	10 x M36
50,500	3,400	6,495	255	4,750	7,135	KZE-340-50500	10 x M36	KZEK-340-50500	10 x M36
53,000	3,400	6,745	255	5,000	7,355	KZE-340-53000	10 x M36	KZEK-340-53000	10 x M36
55,500	3,400	7,195	255	5,250	7,580	KZE-340-55500	12 x M36	KZEK-340-55500	12 x M36
57,500	3,400	7,445	255	5,500	7,810	KZE-340-57500	12 x M36	KZEK-340-57500	12 x M36
60,000	3,400	7,695	255	5,750	8,035	KZE-340-60000	12 x M36	KZEK-340-60000	12 x M36
62,000	3,400	7,945	255	6,000	8,280	KZE-340-62000	12 x M36	KZEK-340-62000	12 x M36
64,000	3,400	8,195	255	6,250	8,515	KZE-340-64000	12 x M36	KZEK-340-64000	12 x M36
66,500	3,400	8,445	255	6,500	8,750	KZE-340-66500	12 x M36	KZEK-340-66500	12 x M36
69,000	3,400	8,695	255	6,750	8,985	KZE-340-69000	12 x M36	KZEK-340-69000	12 x M36
71,000	3,400	8,950	255	7,000	9,235	KZE-340-71000	14 x M36	KZEK-340-71000	14 x M36
73,000	3,400	9,200	255	7,250	9,480	KZE-340-73000	14 x M36	KZEK-340-73000	14 x M36
75,500	3,400	9,450	255	7,500	9,715	KZE-340-75500	14 x M36	KZEK-340-75500	14 x M36
78,000	3,400	9,700	255	7,750	9,960	KZE-340-78000	14 x M36	KZEK-340-78000	14 x M36
80,000	3,400	9,950	255	8,000	10,200	KZE-340-80000	14 x M36	KZEK-340-80000	14 x M36
82,000	3,400	10,200	255	8,250	10,445	KZE-340-82000	16 x M36	KZEK-340-82000	16 x M36
84,500	3,400	10,450	255	8,500	10,685	KZE-340-84500	16 x M36	KZEK-340-84500	16 x M36
87,000	3,400	10,700	255	8,750	10,930	KZE-340-87000	16 x M36	KZEK-340-87000	16 x M36
89,000	3,400	10,950	255	9,000	11,175	KZE-340-89000	16 x M36	KZEK-340-89000	16 x M36



KZE-TANK / CONCENTRATE STORAGE TANK KZEK Ø 3,600 MM

Capacity	ø	h1	h2	h6	D1	Order No.	HV	Order No.	HV
						KZE	KZE	KZEK	KZEK
liter	mm	mm	mm	mm	mm	0.5 bar, density 1.1		0.5 bar, density 1.1 or 0.0 bar, density 1.37	
24,500	3,600	3,340	255	1,500	4,415	KZE-360- 24500	10 x M30	KZEK-360- 24500	10 x M30
27,000	3,600	3,590	255	1,750	4,580	KZE-360- 27000	10 x M30	KZEK-360- 27000	10 x M30
29,500	3,600	3,840	255	2,000	4,755	KZE-360- 29500	10 x M30	KZEK-360- 29500	10 x M30
32,000	3,600	4,090	255	2,250	4,940	KZE-360- 32000	10 x M30	KZEK-360- 32000	10 x M30
35,000	3,600	4,320	255	2,500	5,325	KZE-360- 35000	10 x M30	KZEK-360- 35000	10 x M30
37,500	3,600	4,570	255	2,750	5,520	KZE-360- 37500	10 x M30	KZEK-360- 37500	10 x M30
40,000	3,600	4,820	255	3,000	5,720	KZE-360- 40000	10 x M30	KZEK-360- 40000	10 x M30
42,500	3,600	5,070	255	3,250	5,920	KZE-360- 42500	12 x M36	KZEK-360- 42500	12 x M36
45,000	3,600	5,320	255	3,500	6,125	KZE-360- 45000	12 x M36	KZEK-360- 45000	12 x M36
47,500	3,600	5,570	255	3,750	6,340	KZE-360- 47500	12 x M36	KZEK-360- 47500	12 x M36
50,000	3,600	6,040	255	4,000	6,630	KZE-360- 50000	12 x M36	KZEK-360- 50000	12 x M36
52,500	3,600	6,290	255	4,250	6,845	KZE-360- 52500	12 x M36	KZEK-360- 52500	12 x M36
55,000	3,600	6,540	255	4,500	7,060	KZE-360- 55000	12 x M36	KZEK-360- 55000	12 x M36
57,500	3,600	6,790	255	4,750	7,280	KZE-360- 57500	12 x M36	KZEK-360- 57500	12 x M36
60,000	3,600	7,040	255	5,000	7,505	KZE-360- 60000	12 x M36	KZEK-360- 60000	12 x M36
62,500	3,600	7,290	255	5,250	7,730	KZE-360- 62500	12 x M36	KZEK-360- 62500	12 x M36
65,000	3,600	7,540	255	5,500	7,955	KZE-360- 65000	12 x M36	KZEK-360- 65000	12 x M36
67,500	3,600	7,790	255	5,750	8,185	KZE-360- 67500	12 x M36	KZEK-360- 67500	12 x M36
70,000	3,600	8,040	255	6,000	8,430	KZE-360- 70000	14 x M36	KZEK-360- 70000	14 x M36
72,500	3,600	8,290	255	6,250	8,660	KZE-360- 72500	14 x M36	KZEK-360- 72500	14 x M36
75,000	3,600	8,540	255	6,500	8,895	KZE-360- 75000	14 x M36	KZEK-360- 75000	14 x M36
78,000	3,600	8,790	255	6,750	9,130	KZE-360- 78000	14 x M36	KZEK-360- 78000	14 x M36
80,000	3,600	9,040	255	7,000	9,370	KZE-360- 80000	14 x M36	KZEK-360- 80000	14 x M36
83,000	3,600	9,290	255	7,250	9,605	KZE-360- 83000	16 x M36	KZEK-360- 83000	16 x M36
85,500	3,600	9,540	255	7,500	9,845	KZE-360- 85500	16 x M36	KZEK-360- 85500	16 x M36
88,000	3,600	9,790	255	7,750	10,085	KZE-360- 88000	16 x M36	KZEK-360- 88000	16 x M36
90,000	3,600	10,040	255	8,000	10,330	KZE-360- 90000	16 x M36	KZEK-360- 90000	16 x M36
93,000	3,600	10,290	255	8,250	10,570	KZE-360- 93000	16 x M36	KZEK-360- 93000	16 x M36
95,500	3,600	10,540	255	8,500	10,815	KZE-360- 95500	16 x M36	KZEK-360- 95500	16 x M36
98,000	3,600	10,790	255	8,750	11,055	KZE-360- 98000	16 x M36	KZEK-360- 98000	16 x M36
100,500	3,600	11,045	255	9,000	11,257	KZE-360-100500	18 x M36	KZEK-360-100500	18 x M36
103,000	3,600	11,295	255	9,250	11,494	KZE-360-103000	18 x M36	KZEK-360-103000	18 x M36
105,500	3,600	11,545	255	9,500	11,731	KZE-360-105500	18 x M36	KZEK-360-105500	18 x M36
108,000	3,600	11,795	255	9,750	11,970	KZE-360-108000	18 x M36	KZEK-360-108000	18 x M36
110,500	3,600	12,045	255	10,000	12,208	KZE-360-110500	20 x M36	KZEK-360-110500	20 x M36
113,000	3,600	12,295	255	10,250	12,447	KZE-360-113000	20 x M36	KZEK-360-113000	20 x M36
115,500	3,600	12,545	255	10,500	12,687	KZE-360-115500	20 x M36	KZEK-360-115500	20 x M36
118,000	3,600	12,795	255	10,750	12,926	KZE-360-118000	20 x M36	KZEK-360-118000	20 x M36
120,500	3,600	13,045	255	11,000	13,167	KZE-360-120500	20 x M36	KZEK-360-120500	20 x M36
123,000	3,600	13,295	255	11,250	13,407	KZE-360-123000	20 x M36	KZEK-360-123000	20 x M36

Pressure tank FD-1.2B



For maturing and fermentation we recommend this stainless steel pressure tank. It has been approved up to a pressure of 1.2 bar, proven and tested by the TÜV and its inner 3D surface is very easy to clean.

This model can be either ordered with a vaulted or conical bottom (see pages 96 and 97). This also allows for different types of fermentation and maturing. By default the FD-1.2B is equipped with a double jacket for temperature regulation and therefore can even be used for maturation outside a cooling chamber.

Optionally available with insulating sleeve for an even more efficient effect of the cooling jacket.

APPLICATION RANGE (PRESSURE RANGE UP TO 1.2 BAR)

- Fermentation
- Maturation
- Storage

Ideal for

- Beer
- All kinds of beverages
- Food

STANDARD EQUIPMENT FOR PRESSURE TANK FD-1.2B

- For pressure application up to max. 1.2 bar
- Tank shell made of stainless steel AISI 304 (V2A), IIIId
- Vaulted, stable dished bottom made of stainless steel AISI 304 (V2A), surface IIIId
- From tank-Ø of 1,000 mm upwards with lifting lugs and ladder safety bow
- Outside jacket surface IIIId
- Free-standing on welded-on pipe legs with screw hole
- Made in compliance with pressure equipment guideline 2014 / 68 / EU including TÜV certificate

Sampling

- Weld-on thread NW 10 DIN 11851 (for the installation of the sample tap)

Filling dome

- Up to 120 liter capacity with clamp dome NW150

- From 240 liter capacity upwards with filler neck 400 mm with flap lid

Racking outlet

- Up to 120 liter capacity with internal thread G3/4" with plastic bung
- From 240 liter capacity with external thread G1" with plastic bung

Bottom outlet

- Vaulted, stable dished bottom, in bottom centre with forward drawn discharge pipe
- Up to 120 liter capacity with internal thread G3/4" with plastic bung
- From 240 liter capacity with external thread G1" with plastic bung

Double jacket

- Laser welded double jacket for cooling with two connecting nozzles G 1" with external thread

Pressure regulation

- Nozzle NW 25 DIN 11851 on top end to attach the T-piece armature for CO₂-connection and bunging valve
- Up to 120 liter capacity in the centre of the clamp dome lid
- From 240 liter capacity on top

Temperature

- Weld-on thread NW 10 DIN 11851 for temperature measuring

Type plate

- Mounted on tank

Safety valve

- Set to working pressure 1.2 bar, mounted on tank top



DIMENSIONS OF PRESSURE TANK FD-1.2B

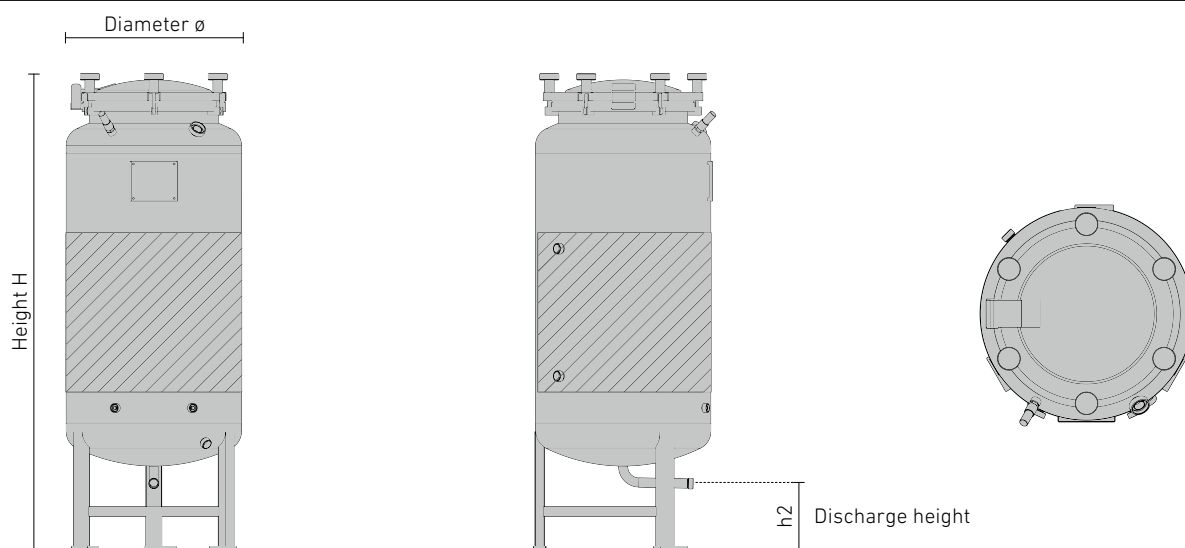

Capacity liter	Capacity hl	ø mm	H mm	h2 mm	Order No.
60	0,60	350	1,033	200	FD -035 -S -V0013
120	1,20	440	1,251	200	FD -044 -S -V0050
240	2,40	550	1,463	200	FD -055 -S -V0045
625	6,25	820	1,727	200	FD -082 -S -V0064
1,150	11,50	1,000	2,135	225	FD -100 -S -V0001

All tank variations are also available with DIN or Clamp connections as standard.

PRESSURE TANK FD-1.2B WITH INSULATING SLEEVE

Capacity liter	Capacity hl	ø mm	H mm	h2 mm	Order No.
60	0,60	350	1,033	200	45714
120	1,20	440	1,251	200	45710
240	2,40	550	1,463	200	45711
625	6,25	820	1,727	200	45712
1,150	11,50	1,000	2,135	225	45713



Pressure tank ZKG-1.2B

The conical design of the maturing pressure tank is often used for the one tank method. The yeast is gathered in the cone and, depending on the model you have, can be removed. The beer does not need to be decanted.

It is also the ideal supplement to the 50 / 200 / 500 or 1,000 liter Braumeister.

The ZKG-1.2B is approved for a pressure of up to 1.2 bar and quality documented by the TÜV, Germany's Technical Control Board. In case of even higher requirements you will find tanks that are approved for higher operating pressure on the next pages.

Optionally available with insulating sleeve for an even more efficient effect of the cooling jacket.

APPLICATION RANGE (PRESSURE RANGE UP TO 1.2 BAR)

- Fermentation
- Maturation
- Storage

Ideal for

- Beer
- All kinds of beverages
- Food

STANDARD EQUIPMENT FOR PRESSURE TANK ZKG-1.2B

- For pressure application up to max. 1.2 bar
- Tank shell made of stainless steel AISI 304 (V2A), IIIId
- Vaulted, stable dished bottom as top end made of stainless steel AISI 304 (V2A), surface IIIId
- Stable cone bottom end approx. 60°, made of stainless steel AISI 304 (V2A) surface IIIId/IIIc
- From tank- \varnothing of 1,000 mm upwards with lifting lugs and ladder safety bow
- Outside shell surface IIIId
- Free-standing on welded-on pipe legs with mounting hole
- Made in compliance with pressure equipment guidelines 2014 / 68 / EU including TÜV certificate

Sampling

- Weld-on thread NW10 DIN11851 (for the installation of the sample tap)

Filling dome

- Up to 120 liter capacity with clamp dome NW150
- From 240 liter capacity upwards with filler neck 400 mm with flap lid

Racking outlet

- Up to 120 liter capacity with internal thread G3/4" with plastic bung
- From 240 liter capacity with external thread G1" with plastic bung

Bottom outlet

- Up to 120 liter capacity with internal thread G3/4" with plastic bung
- From 240 liter capacity with external thread G1" with plastic bung

Double jacket

- Laser welded double jacket for cooling with two connecting nozzles G 1" with external thread

Pressure regulation

- Nozzle NW 25 DIN 11851 on top end to attach the T-piece armature for CO₂-connection and bunging valve
- Up to 120 liter capacity in the centre of the clamp dome lid
- From 240 liter capacity on top

Temperature

- Weld-on thread NW 10 DIN 11851 for temperature measuring

Type plate

- Mounted on tank

Safety valve

- Set to working pressure 1.2 bar, mounted on tank top



DIMENSIONS OF PRESSURE TANK ZKG-1.2B

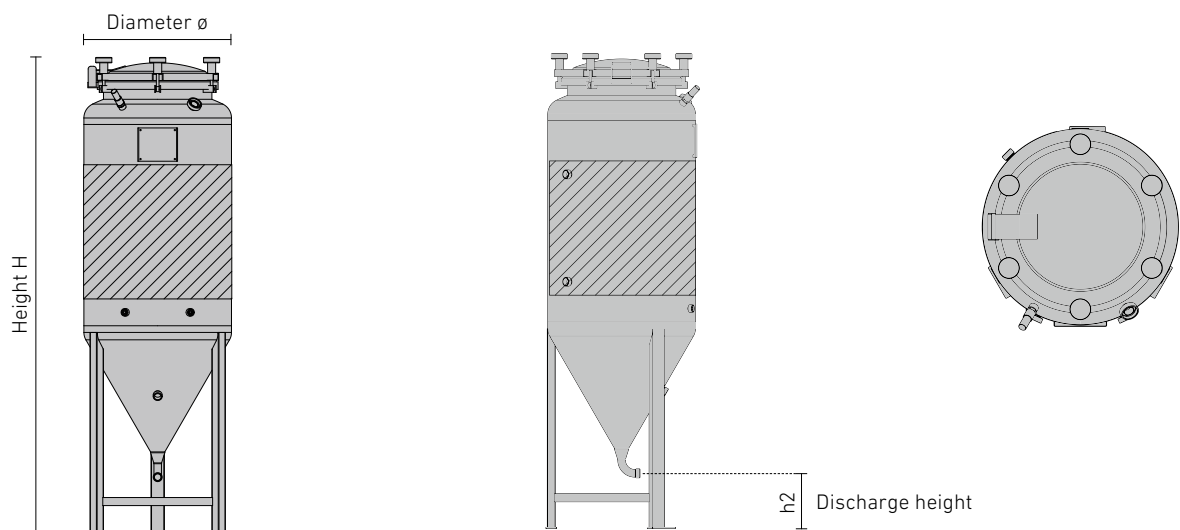

Capacity	Capacity	ø	H	h2	Order No.
liter	hl	mm	mm	mm	
60	0,60	350	1,201	200	FD -035 -S -V0011
120	1,20	440	1,419	200	FD -044 -S -V0048
240	2,40	550	1,732	200	FD -055 -S -V0043
625	6,25	820	2,020	200	FD -082 -S -V0063
1,200	12,00	1,000	2,776	317	FD -100 -S -V0003

All tank variations are also available with DIN or Clamp connections as standard.

PRESSURE TANK ZKG-1.2B WITH INSULATING SLEEVE

Capacity	Capacity	ø	H	h2	Order No.
liter	hl	mm	mm	mm	
60	0.60	350	1,201	200	45714-ZKG
120	1.20	440	1,419	200	45710-ZKG
240	2.40	550	1,732	200	45711-ZKG
625	6.25	820	2,020	200	45712-ZKG
1.200	12.00	1,000	2,776	317	45713-ZKG



Pressure tank FD-2.5B

For maturing and fermentation we recommend this stainless pressure tank. If you want to have a higher pressure range to make beer with higher temperature and pressure for example wheat beer. It has been approved up to a pressure of 2.5 bar, proven and tested by the TÜV.

This model can be either ordered with a vaulted or conical bottom (see pages 100 and 101). It can be ideally used with the Braumeister 50 / 200 / 500 liter and 1,000 liter.

Optionally available with insulating sleeve for an even more efficient effect of the cooling jacket.

APPLICATION RANGE (PRESSURE RANGE UP TO 2.5 BAR)

- Fermentation
- Maturation
- Storage

Ideal for

- Beer
- All kinds of beverages
- Food

STANDARD EQUIPMENT FOR PRESSURE TANK FD-2.5B

- For pressure application up to max. 2.5 bar
- Tank shell made of stainless steel AISI 304 (V2A), III d
- Vaulted, stable dished bottom made of stainless steel AISI 304 (V2A), surface III d
- Outside shell surface III d/III c
- From tank- \varnothing of 1,000 mm upwards with lifting lugs and ladder safety bow
- Free-standing on welded-on pipe legs with screw hole
- Made in compliance with pressure equipment guideline 2014 / 68 / EU including TÜV certificate

Sampling

- Weld-on thread NW 10 DIN 11851 (for the installation of the sample tap)

Filling dome

- Up to 120 liter capacity with clamp dome NW150

- From 240 liter capacity upwards with filler neck 400 mm with flap lid

Racking outlet

- Up to 120 liter capacity with internal thread G3/4" with plastic bung
- From 240 liter capacity with external thread G1" with plastic bung

Bottom outlet

- Vaulted, stable dished bottom, in bottom centre with forward drawn discharge pipe
- Up to 120 liter capacity with internal thread G3/4" with plastic bung
- From 240 liter capacity with external thread G1" with plastic bung

Double jacket

- Laser welded double jacket for cooling with two connecting nozzles G 1" with external thread

Pressure regulation

- Nozzle NW 25 DIN 11851 on top end to attach the T-piece armature for CO₂-connection and bunging valve
- Up to 120 liter capacity in the centre of the clamp dome lid
- From 240 liter capacity on top

Temperature

- Weld-on thread NW 10 DIN 11851 for temperature measuring

Type plate

- Mounted on tank

Safety valve

- Set to working pressure 2.5 bar, mounted on tank top



DIMENSIONS OF PRESSURE TANK FD-2.5B

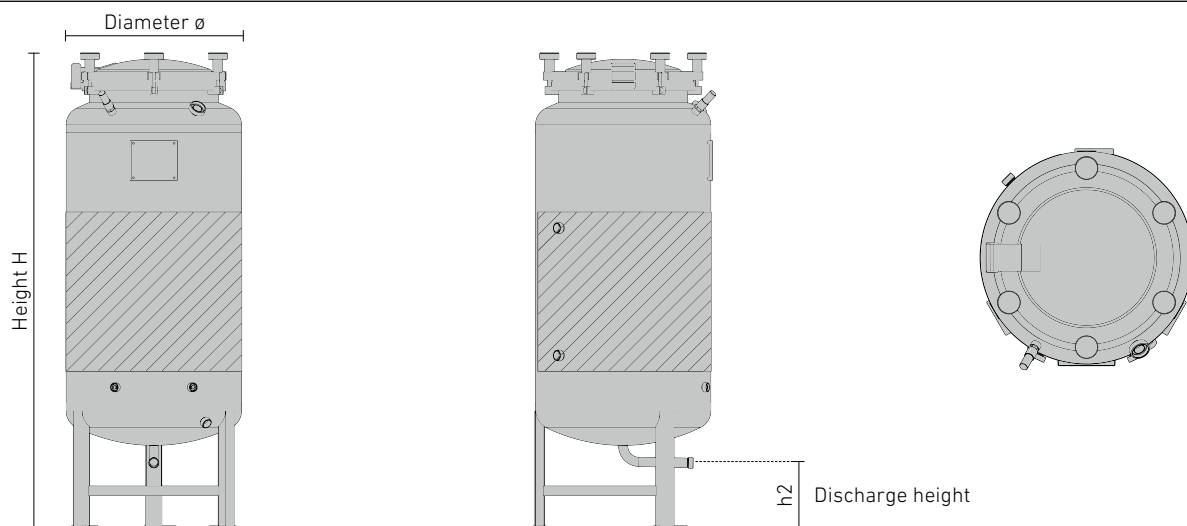

Capacity liter	Capacity hl	ø mm	H mm	h2 mm	Order No.
60	0.60	350	1,033	200	FD -035 -S -V0012
120	1.20	440	1,251	200	FD -044 -S -V0049
240	2.40	550	1,523	200	FD -055 -S -V0082
625	6.25	820	1,788	200	FD -082 -S -V0113
1,150	11.50	1,000	2,135	225	FD -100 -S -V0002

All tank variations are also available with DIN or Clamp connections as standard.

PRESSURE TANK FD-2.5B WITH INSULATING SLEEVE

Capacity liter	Capacity hl	ø mm	H mm	h2 mm	Order No.
60	0.60	350	1,033	200	45814
120	1.20	440	1,251	200	45810
240	2.40	550	1,523	200	45811
625	6.25	820	1,788	200	45812
1,150	11.50	1,000	2,135	225	45813



Pressure tank ZKG-2.5B

Speidel's pressure tank is the unrivalled solution for fermentation and maturing. This type of tank is often used for the one tank method. The higher approval up to 2.5 bar working pressure gives the customer more range and possibilities for its application. The yeast is gathered in the cone and can be removed. The beer does not need to be decanted.

It is also the ideal supplement to the 100 / 200 / 500 or 1,000 liter Braumeister. The FD-2.5B-ZKG is approved for a pressure of up to 2.5 bar and quality documented by the TÜV, Germany's Technical Control Board.

Optionally available with insulating sleeve for an even more efficient effect of the cooling jacket.

APPLICATION RANGE (PRESSURE RANGE UP TO 2.5 BAR)

- Fermentation
- Maturation
- Storage

Ideal for

- Beer
- All kinds of beverages
- Food

STANDARD EQUIPMENT FOR PRESSURE TANK ZKG-2.5B

- For pressure application up to max. 2.5 bar
- Tank shell made of stainless steel AISI 304 (V2A), IIIId
- Vaulted, stable dished bottom as top end made of stainless steel AISI 304 (V2A), surface IIIId
- Stable cone bottom end approx. 60°, made of stainless steel AISI 304 (V2A) surface IIIId / IIIc
- Outside shell surface IIIId
- Free-standing on welded-on pipe legs with mounting hole
- Made in compliance with pressure equipment guidelines 2014 / 68 / EU including TÜV certificate

Sampling

- Weld-on thread NW 10 DIN 11851

Filling dome

- Up to 120 liter clamp dome NW150
- From capacity 240 liter filling dome NW 400 with flap lid

Racking outlet

- Up to 120 liter capacity with internal thread G3/4" with plastic bung
- From 240 liter capacity with external thread G1" with plastic bung

Bottom outlet

- Up to 120 liter capacity with internal thread G3/4" with plastic bung
- From 240 liter capacity with external thread G1" with plastic bung

Double jacket

- Laser welded double jacket for cooling with two connecting nozzles G 1" with external thread

Pressure regulation

- Nozzle NW 25 DIN 11851 on top end to attach the T-piece armature for CO₂-connection and bunging valve
- Up to capacity 120 liter in the centre of the clamp dome
- From capacity 240 liter on top

Temperature

- Weld-on thread NW 10 DIN 11851 for temperature measuring

Type plate

- Mounted on tank

Safety valve

- Set to 2.5 bar working pressure, mounted on tank top



DIMENSIONS OF PRESSURE TANK ZKG-2.5B

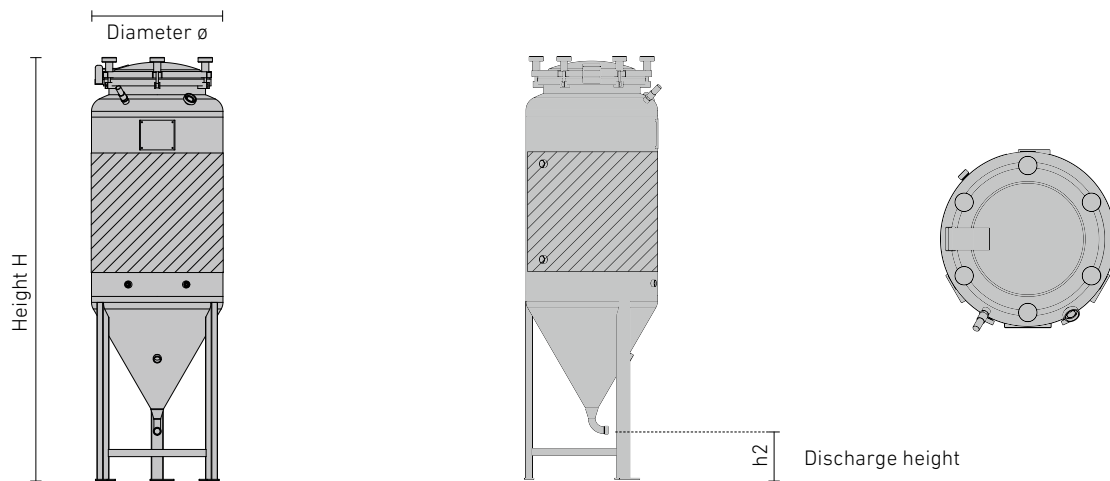

Capacity liter	Capacity hl	ø mm	H mm	h2 mm	Order No.
60	0.60	350	1,201	200	FD -035 -S -V0008
120	1.20	440	1,484	200	FD -044 -S -V0054
240	2.40	550	1,793	200	FD -055 -S -V0083
625	6.25	820	2,210	200	FD -082 -S -V0114
1,200	12.00	1,000	2,782	317	FD -100 -S -V0004

All tank variations are also available with DIN or Clamp connections as standard.

PRESSURE TANK ZKG-2.5B WITH INSULATING SLEEVE

Capacity liter	Capacity hl	ø mm	H mm	h2 mm	Order No.
60	0.60	350	1,201	200	45814-ZKG
120	1.20	440	1,484	200	45815-ZKG
240	2.40	550	1,793	200	45811-ZKG
625	6.25	820	2,210	200	45812-ZKG
1,200	12.00	1,000	2,782	317	45813-ZKG

Pressure tank ZKG-3B

For a higher demand of beer we also offer bigger tanks approved and constructed till 3 bar working pressure, customized individually for your needs. This cylindrical-conical fermentation tank is ideal for the main fermentation and maturing. The yeast is gathered in the centre of the cone at the bottom of the tank.

Depending on the model, the yeast can be removed at the bottom outlet. Alternatively, a racking outlet at the cone can be used to extract the clarified beer. This model is mostly used with the one tank method.



APPLICATION RANGE (PRESSURE RANGE UP TO 3.0 BAR)

- Fermentation
- Maturation
- Storage

Ideal for

- Beer
- All kinds of beverages
- Food





STANDARD EQUIPMENT FOR PRESSURE TANK ZKG-3B

- For pressure application up to max. 3.0 bar
- Tank shell made of stainless steel AISI 304 (V2A), IIIc / III d
- Tank top made of stainless steel AISI 304 (V2A), IIIc / III d
- Cone bottom approx. 60° made of stainless steel AISI 304 (V2A), surface IIIc / III d
- Surface outside marbled or brushed
- Ladder safety bow (from 2,000 mm tank height onward)
- Free-standing on welded-on pipe legs
- Made in compliance with pressure equipment guidelines 2014 / 68 / EU

Sampling

- Weld-on thread NW 10 DIN 11851 (for the installation of the sample tap)

Filling dome at 300 liter (3.0 hl)

- Filling dome NW 400 with flap lid

Manhole from 800 liter (8.0 hl) upwards

- Welded stable manhole neck 340x440 mm, door with swivelling handle and toggle nut

Cleaning pipe from 800 liter (8.0 hl) upwards

- Cleaning spray head, drill hole 360° with spray head holder, including cleaning pipe, connection thread NW 40

Bottom outlet

- Dimensionally stable cone bottom approx. 60°, with outlet pipe drawn forward, outlet NW 40 DIN 11851











Type plate

- Mounted on tank edge

Safety valve

- Set to 3.0 bar operating pressure, mounted on tank top

SET-UP EXAMPLE FOR PRESSURE TANK ZKG-3B

Item	Order No.
	<p>Pressure tank ZKG-160-3-5500 liter</p> <ul style="list-style-type: none"> · h1 = 4,172 mm, · $H_{\text{compl.}} = 4,172 \text{ mm (h1)} + 150 \text{ mm (cleaning pipe)}$ · + approx. 100 mm (height compensation) = 4,422 mm · Standard equipment as on page 103 <p style="text-align: right;">ZKG-160-3-5500</p>
	<p>Cleaning pipe (page 172)</p> <ul style="list-style-type: none"> · With disc valve NW 40 <p style="text-align: right;">61375</p>
	<p>Sampling (page 176)</p> <ul style="list-style-type: none"> · With sampling tap NW 10 DIN 11851 · With spiral <p style="text-align: right;">83922 83866</p>
	<p>Racking outlet (page 172)</p> <ul style="list-style-type: none"> · Racking outlet and bottom outlet armature 100 / 40 · With disc valve NW 40 DIN 11851 <p style="text-align: right;">91999 61375</p>
	<p>Bottom outlet (page 172)</p> <ul style="list-style-type: none"> · With disc valve NW 40 DIN 11851 <p style="text-align: right;">61375</p>
	<p>Bunging apparatus (page 186)</p> <ul style="list-style-type: none"> · Bung pressure regulation ("Kellerfee") · Up to 3 bar for junction NW 25 DIN 11851 on cleaning pipe <p style="text-align: right;">81457</p>
	<p>Heating and cooling jacket (page 128)</p> <ul style="list-style-type: none"> · Double jacket F 5.3m² with welded gland thread G 1" · for connection to available warm water / cold water source · Version 1, connection position F3 · With cone double jacket 2.3m² <p style="text-align: right;">1F3 1F3</p>
	<p>Temperature measurement (page 180)</p> <ul style="list-style-type: none"> · Bi-metal dial thermometer ø 100 mm, measuring range - 20 °C to + 60 °C · Length = 125 mm · Including welded-on sleeve for thermometer <p style="text-align: right;">TM-140F</p>
	<p>Fill level (page 177)</p> <ul style="list-style-type: none"> · Fill level indicator NW 10 DIN 11851 with liter scale · Closed version · Connection between level indicator and cleaning pipe <p style="text-align: right;">FS-130I VL50A</p>
	<p>Adjustable feet (page 184)</p> <ul style="list-style-type: none"> · With adjustable feet for tank legs (H = + approx. 100 mm) <p style="text-align: right;">46125</p>
<p>TÜV-fees (fees for German Technical Control Board) including technical approval and documentation</p>	<p>TÜV-001</p>

DIMENSIONS OF PRESSURE TANK ZKG-3B

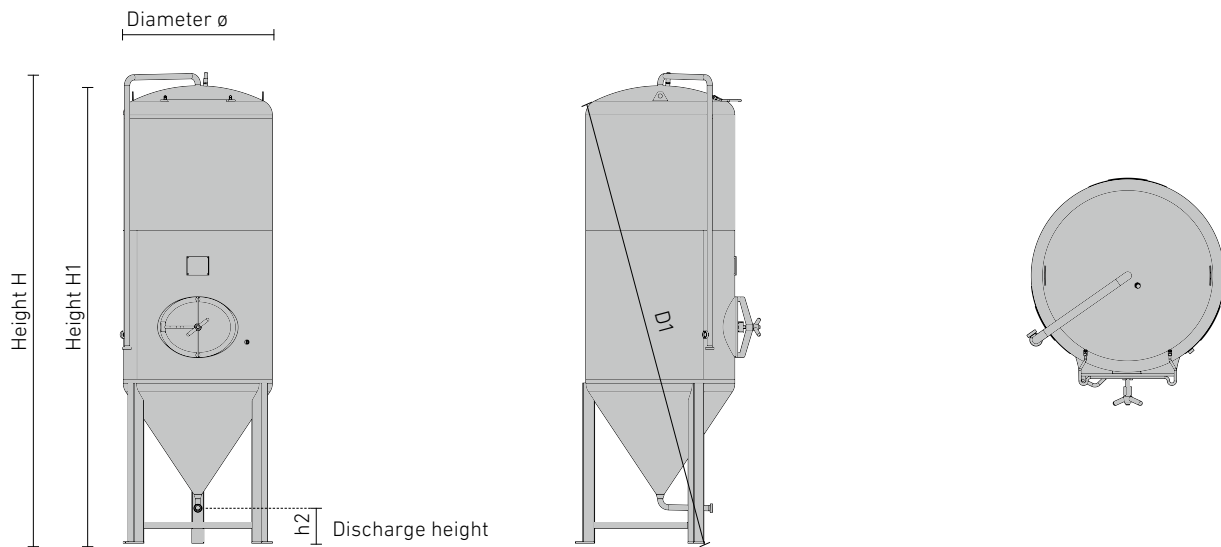

PRESSURE TANK ZKG-3B Ø 630 MM

Capacity	Capacity	ø	h1	H	h2	D1	Order No.
liter	hl	mm	mm	mm	mm	mm	
300	3.0	630	1,798	1,978	300	1,924	ZKG-063-3-0300

PRESSURE TANK ZKG-3B Ø 1.000 MM

Capacity	Capacity	ø	h1	H	h2	D1	Order No.
liter	hl	mm	mm	mm	mm	mm	
800	8.0	1,000	2,148	2,298	300	2,260	ZKG-100-3-0800
900	9.0	1,000	2,263	2,413	300	2,390	ZKG-100-3-0900
1,100	11.0	1,000	2,523	2,673	300	2,640	ZKG-100-3-1100
1,200	12.0	1,000	2,606	2,756	300	2,750	ZKG-100-3-1200
1,500	15.0	1,000	3,043	3,193	300	2,130	ZKG-100-3-1500
1,700	17.0	1,000	3,261	3,411	300	3,370	ZKG-100-3-1700
1,800	18.0	1,000	3,435	3,585	300	3,540	ZKG-100-3-1800
2,050	20.5	1,000	3,761	3,882	300	3,870	ZKG-100-3-2050
2,250	22.5	1,000	4,011	4,161	300	4,120	ZKG-100-3-2250

PRESSURE TANK ZKG-3B Ø 1.200 MM

Capacity	Capacity	ø	h1	H	h2	D1	Order No.
liter	hl	mm	mm	mm	mm	mm	
1,800	18.0	1,200	2,807	2,957	300	2,960	ZKG-120-3-1800
2,000	20.0	1,200	2,978	3,128	300	3,100	ZKG-120-3-2000
2,400	24.0	1,200	3,308	3,458	300	3,460	ZKG-120-3-2400
3,000	30.0	1,200	3,917	4,067	300	4,010	ZKG-120-3-3000
3,300	33.0	1,200	4,241	4,391	300	4,330	ZKG-120-3-3300

PRESSURE TANK ZKG-3B Ø 1,400 MM

Capacity liter	Capacity hl	Ø mm	h1 mm	H mm	h2 mm	D1 mm	Order No.
2,400	24.0	1,400	3,095	3,245	300	3,040	ZKG-140-3-2400
3,000	30.0	1,400	3,310	3,460	300	3,430	ZKG-140-3-3000
3,600	36.0	1,400	3,711	3,861	300	3,830	ZKG-140-3-3600
4,000	40.0	1,400	3,961	4,111	300	4,080	ZKG-140-3-4000
4,400	44.0	1,400	4,211	4,361	300	4,330	ZKG-140-3-4400
4,700	47.0	1,400	4,461	4,611	300	4,580	ZKG-140-3-4700
5,100	51.0	1,400	4,711	4,861	300	5,080	ZKG-140-3-5100
5,500	55.0	1,400	4,961	5,111	300	5,330	ZKG-140-3-5500

PRESSURE TANK ZKG-3B Ø 1,600 MM

Capacity liter	Capacity hl	Ø mm	h1 mm	H mm	h2 mm	D1 mm	Order No.
3,500	35.0	1,600	3,406	3,556	300	3,655	ZKG-160-3- 3500
4,000	40.0	1,600	3,656	3,806	300	3,891	ZKG-160-3- 4000
4,500	45.0	1,600	3,906	4,056	300	4,128	ZKG-160-3- 4500
5,000	50.0	1,600	4,156	4,306	300	4,367	ZKG-160-3- 5000
5,500	55.0	1,600	4,406	4,556	300	4,607	ZKG-160-3- 5500
6,000	60.0	1,600	4,656	4,806	300	4,848	ZKG-160-3- 6000
6,500	65.0	1,600	4,906	5,056	300	5,090	ZKG-160-3- 6500
7,000	70.0	1,600	5,156	5,306	300	5,333	ZKG-160-3- 7000
7,500	75.0	1,600	5,406	5,556	300	5,576	ZKG-160-3- 7500

PRESSURE TANK ZKG-3B Ø 1,800 MM

Capacity liter	Capacity hl	Ø mm	h1 mm	H mm	h2 mm	D1 mm	Order No.
4,750	47.5	1,800	3,661	3,811	300	3,947	ZKG-180-3-4750
5,400	54.0	1,800	3,831	3,981	300	4,182	ZKG-180-3-5400
6,000	60.0	1,800	4,161	4,311	300	4,418	ZKG-180-3-6000
6,600	66.0	1,800	4,411	4,561	300	4,656	ZKG-180-3-6600
7,200	72.0	1,800	4,661	4,811	300	4,895	ZKG-180-3-7200
7,800	78.0	1,800	4,911	5,061	300	5,135	ZKG-180-3-7800
8,500	85.0	1,800	5,161	5,311	300	5,376	ZKG-180-3-8500
9,100	91.0	1,800	5,411	5,561	300	5,617	ZKG-180-3-9100
9,700	97.0	1,800	5,661	5,811	300	5,860	ZKG-180-3-9700



PRESSURE TANK ZKG-3B Ø 2,000 MM

Capacity liter	Capacity hl	Ø mm	h1 mm	H mm	h2 mm	D1 mm	Order No.
6,200	62.0	2,000	3,886	4,036	300	4,211	ZKG-200-3- 6200
6,900	69.0	2,000	4,136	4,286	300	4,445	ZKG-200-3- 6900
7,700	77.0	2,000	4,386	4,536	300	4,585	ZKG-200-3- 7700
8,500	85.0	2,000	4,636	4,786	300	4,916	ZKG-200-3- 8500
9,200	92.0	2,000	4,886	5,036	300	5,154	ZKG-200-3- 9200
10,000	100.0	2,000	5,136	5,286	300	5,393	ZKG-200-3-10000
10,800	108.0	2,000	5,386	5,536	300	5,633	ZKG-200-3-10800
11,500	115.0	2,000	5,636	5,786	300	5,873	ZKG-200-3-11500
12,300	123.0	2,000	5,886	6,036	300	6,115	ZKG-200-3-12300

PRESSURE TANK ZKG-3B Ø 2,200 MM

Capacity liter	Capacity hl	Ø mm	h1 mm	H mm	h2 mm	D1 mm	Order No.
7,800	78.0	2,200	4,119	4,269	300	4,684	ZKG-220-3- 7800
8,800	88.0	2,200	4,369	4,519	300	4,716	ZKG-220-3- 8800
9,700	97.0	2,200	4,619	4,769	300	4,950	ZKG-220-3- 9700
10,500	105.0	2,200	4,869	5,019	300	5,185	ZKG-220-3-10500
11,500	115.0	2,200	5,119	5,269	300	5,422	ZKG-220-3-11500
12,500	125.0	2,200	5,369	5,519	300	5,660	ZKG-220-3-12500
14,300	143.0	2,200	5,869	6,019	300	6,138	ZKG-220-3-14300
15,200	152.0	2,200	6,119	6,269	300	6,379	ZKG-220-3-15200
17,200	172.0	2,200	6,619	6,769	300	6,862	ZKG-220-3-17200
18,000	180.0	2,200	6,869	7,019	300	7,104	ZKG-220-3-18000
20,000	200.0	2,200	7,369	7,519	300	7,591	ZKG-220-3-20000



Pressure tank FS-M0-1B

The FS-M0-1B is suitable for low pressure fermentation and maturing up to 1 bar working pressure.

It is the classic model for brewing beer with the two tank method. But this low pressure tank is suitable for any other media as well.

APPLICATION RANGE (PRESSURE RANGE UP TO 1.0 BAR)

- Fermentation
- Maturation
- Storage

Ideal for

- Beer
- All kinds of beverages
- Food
- Plant construction
- Industry





STANDARD EQUIPMENT FOR PRESSURE TANK FS-MO-1B

- For pressure application up to max. 1.0 bar
- Tank shell made of stainless steel AISI304 (V2A), IIIc / III d
- Tank bottom made of stainless steel AISI304 (V2A), surface IIIc / III d
- Tank top made of stainless steel AISI304 (V2A), surface IIIc / III d
- Surface outside marbled or brushed
- Ladder safety bow (from 2,000 mm tank height upwards)
- Free-standing on welded-on box-shaped legs
- Made in compliance with pressure equipment guidelines 2014 / 68 / EU

Sampling

- Weld-on thread NW 10 DIN 11851 (for the installation of the sample tap)

Filling dome at 280 liter (2,8 hl)

- Filling dome NW 400 with flap lid manhole

From 750 liter (7.5 hl) upwards

- Welded stable manhole neck 340 x 440 mm, door with swivelling handle and toggle nut

Cleaning pipe from 750 liter (7.5 hl) upwards

- Cleaning spray head, punch hole 360° with spray head holder, including cleaning hose, connection thread NW 40 DIN 11851

Bottom outlet

- Vaulted, dimensionally stable tank bottom, with outlet pipe drawn forward, outlet NW 40 DIN 11851











Type plate

- Mounted on tank

Safety valve

- Set to 1.0 bar working pressure, mounted on tank top

SET-UP EXAMPLE FOR PRESSURE TANK FS-MO-1B

Item	Order No.
	<p>Pressure tank FS-MO-100-1B-1150 liter</p> <ul style="list-style-type: none"> · h1 = 2,075 mm, · $H_{\text{compl.}} = 2,075 \text{ mm (h1)} + 150 \text{ mm (cleaning pipe)} + \text{approx. } 100 \text{ mm (height compensation)} = 2,325 \text{ mm}$ · Standard equipment as on page 109 <p style="text-align: right;">FS-MO-100-1-1150</p>
	<p>Cleaning pipe (page 172)</p> <ul style="list-style-type: none"> · With disc valve NW 40 <p style="text-align: right;">61375</p>
	<p>Sampling (page 176)</p> <ul style="list-style-type: none"> · With sampling tap NW 10 DIN 11851 · With spiral <p style="text-align: right;">83922 83866</p>
	<p>Racking outlet (page 172)</p> <ul style="list-style-type: none"> · Welded gland with thread NW 40 DIN 11851 · With disc valve NW 40 DIN 11851 <p style="text-align: right;">KA141G 61375</p>
	<p>Bottom outlet (page 172)</p> <ul style="list-style-type: none"> · With disc valve NW 40 DIN 11851 <p style="text-align: right;">61375</p>
	<p>Bunging apparatus (page 186)</p> <ul style="list-style-type: none"> · Bunging apparatus Pico <p style="text-align: right;">87712</p>
	<p>Heating and cooling jacket (page 128)</p> <ul style="list-style-type: none"> · Double jacket F 1.5 m² with welded gland thread G 1" for connection to available warm water / cold water source · Version 1, connection position F11 <p style="text-align: right;">1F11</p>
	<p>Temperature measurement (page 180)</p> <ul style="list-style-type: none"> · Bi-metal dial thermometer ø 100 mm, measuring range - 20 °C to + 60 °C · Length = 125 mm · Including welded-on sleeve for thermometer <p style="text-align: right;">TM-140F</p>
	<p>Fill level (page 177)</p> <ul style="list-style-type: none"> · Fill level indicator NW 10 DIN 11851 with liter scale · Closed version · Connection between fill level indicator and cleaning pipe <p style="text-align: right;">FS-130H VL-50A</p>
	<p>Adjustable feet (page 184)</p> <ul style="list-style-type: none"> · With adjustable feet for tank legs (H = + approx. 100 mm) <p style="text-align: right;">46127</p>
<p>TÜV-fees (fees for German Technical Control Board)</p>	

STANDARD EQUIPMENT PRESSURE TANK FS-MO-1B

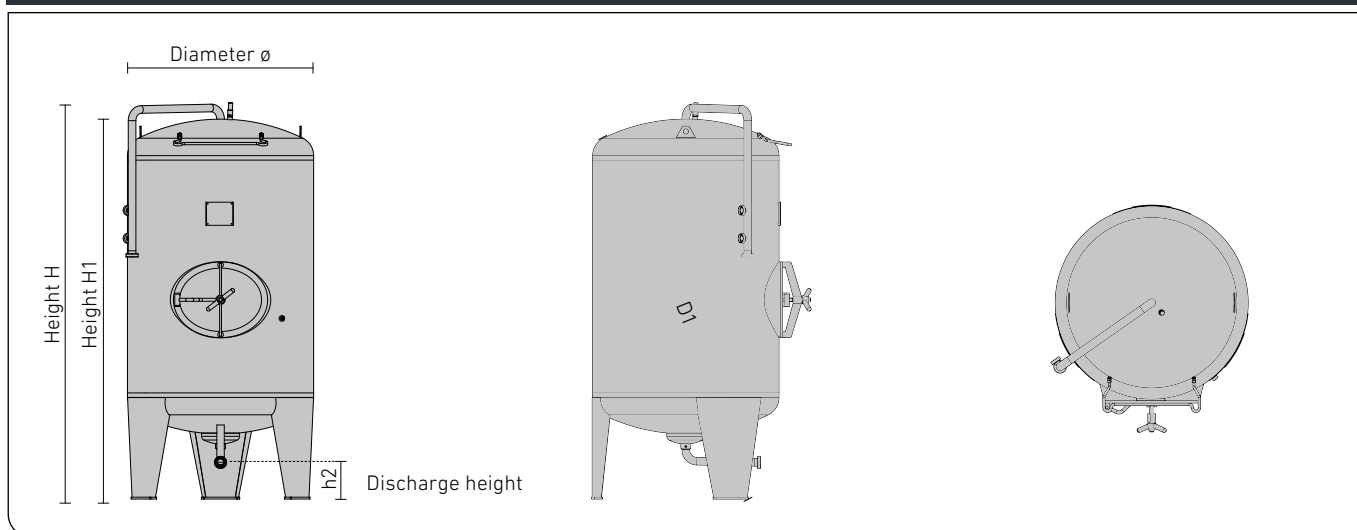

PRESSURE TANK FS-MO-1B Ø 630 MM

Capacity	Capacity	ø	h1	H	h2	D1	Order No.
liter	hl	mm	mm	mm	mm	mm	
280	2.8	630	1,255	1,555	225	1,614	FD-063-1-0280

PRESSURE TANK FS-MO-1B Ø 1,000 MM

Capacity	Capacity	ø	h1	H	h2	D1	Order No.
liter	hl	mm	mm	mm	mm	mm	
750	7.5	1,000	1,578	1,728	225	1,841	FS-MO-100-1-0750
950	9.5	1,000	1,825	1,975	225	1,985	FS-MO-100-1-0950
1,150	11.5	1,000	2,075	2,225	225	2,210	FS-MO-100-1-1150
1,350	13.5	1,000	2,325	2,475	225	2,440	FS-MO-100-1-1350
1,500	15.0	1,000	2,575	2,725	225	2,680	FS-MO-100-1-1500
1,700	17.0	1,000	2,825	2,975	225	2,920	FS-MO-100-1-1700
1,900	19.0	1,000	3,075	3,225	225	3,137	FS-MO-100-1-1900
2,100	21.0	1,000	3,325	3,475	225	3,384	FS-MO-100-1-2100

PRESSURE TANK FS-MO-1B Ø 1,200 MM

Capacity	Capacity	ø	h1	H	h2	D1	Order No.
liter	hl	mm	mm	mm	mm	mm	
1,450	14.5	1,200	1,897	2,047	225	2,135	FS-MO-120-1-1450
1,750	17.5	1,200	2,147	2,297	225	2,340	FS-MO-120-1-1750
2,000	20.0	1,200	2,397	2,547	225	2,560	FS-MO-120-1-2000
2,250	22.5	1,200	2,647	2,797	225	2,795	FS-MO-120-1-2250
2,550	25.5	1,200	2,897	3,047	225	3,030	FS-MO-120-1-2550
2,800	28.0	1,200	3,147	3,297	225	3,221	FS-MO-120-1-2800
3,100	31.0	1,200	3,397	3,547	225	3,466	FS-MO-120-1-3100

PRESSURE TANK FS-MO-1B Ø 1,400 MM

Capacity	Capacity	Ø	h1	H	h2	D1	Order No.
liter	hl	mm	mm	mm	mm	mm	
2,100	21.0	1,400	2,017	2,167	225	2,153	FS-MO-140-1-2100
2,450	24.5	1,400	2,267	2,417	225	2,364	FS-MO-140-1-2450
2,850	28.5	1,400	2,517	2,667	225	2,589	FS-MO-140-1-2850
3,200	32.0	1,400	2,767	2,917	225	2,819	FS-MO-140-1-3200
3,600	36.0	1,400	3,017	3,167	225	3,055	FS-MO-140-1-3600
4,000	40.0	1,400	3,267	3,417	225	3,295	FS-MO-140-1-4000
4,300	43.0	1,400	3,517	3,667	225	3,537	FS-MO-140-1-4300
4,700	47.0	1,400	3,767	3,917	225	3,780	FS-MO-140-1-4700
5,100	51.0	1,400	4,017	4,167	225	4,025	FS-MO-140-1-5100

PRESSURE TANK FS-MO-1B Ø 1,600 MM

Capacity	Capacity	Ø	h1	H	h2	D1	Order No.
liter	hl	mm	mm	mm	mm	mm	
2,800	28.0	1,600	2,087	2,237	225	2,428	FS-MO-160-1-2800
3,300	33.0	1,600	2,337	2,487	225	2,676	FS-MO-160-1-3300
3,800	38.0	1,600	2,587	2,737	225	2,899	FS-MO-160-1-3800
4,300	43.0	1,600	2,837	2,987	225	3,126	FS-MO-160-1-4300
4,800	48.0	1,600	3,087	3,237	225	3,357	FS-MO-160-1-4800
5,300	53.0	1,600	3,337	3,487	225	3,590	FS-MO-160-1-5300
5,800	58.0	1,600	3,587	3,737	225	3,825	FS-MO-160-1-5800
6,300	63.0	1,600	3,837	3,987	225	4,062	FS-MO-160-1-6300
6,800	68.0	1,600	4,087	4,237	225	4,301	FS-MO-160-1-6800

PRESSURE TANK FS-MO-1B Ø 1,800 MM

Capacity	Capacity	Ø	h1	H	h2	D1	Order No.
liter	hl	mm	mm	mm	mm	mm	
3,700	37.0	1,800	2,157	2,307	225	2,488	FS-MO-180-1-3700
4,300	43.0	1,800	2,407	2,557	225	2,687	FS-MO-180-1-4300
5,000	50.0	1,800	2,657	2,807	225	2,594	FS-MO-180-1-5000
5,500	55.0	1,800	2,907	3,057	225	3,108	FS-MO-180-1-5500
6,200	62.0	1,800	3,157	3,307	225	3,333	FS-MO-180-1-6200
6,800	68.0	1,800	3,407	3,557	225	3,562	FS-MO-180-1-6800
7,400	74.0	1,800	3,657	3,807	225	3,796	FS-MO-180-1-7400
8,100	81.0	1,800	3,907	4,057	225	4,034	FS-MO-180-1-8100
8,700	87.0	1,800	4,157	4,307	225	4,274	FS-MO-180-1-8700

PRESSURE TANK FS-MO-1B Ø 2,000 MM

Capacity liter	Capacity hl	Ø mm	h1 mm	H mm	h2 mm	D1 mm		Order No.
4,700	47.0	2,000	2,268	2,418	300	2,788		FS-MO-200-1- 4700
5,500	55.0	2,000	2,518	2,668	300	2,996		FS-MO-200-1- 5500
6,300	63.0	2,000	2,768	2,918	300	3,209		FS-MO-200-1- 6300
7,000	70.0	2,000	3,006	3,156	300	3,429		FS-MO-200-1- 7000
7,800	78.0	2,000	3,256	3,406	300	3,652		FS-MO-200-1- 7800
8,600	84.0	2,000	3,506	3,656	300	3,878		FS-MO-200-1- 8600
9,400	94.0	2,000	3,756	3,906	300	4,108		FS-MO-200-1- 9400
10,100	101.0	2,000	4,006	4,156	300	4,339		FS-MO-200-1-10100
10,900	109.0	2,000	4,256	4,406	300	4,573		FS-MO-200-1-10900

PRESSURE TANK FS-MO-1B Ø 2,200 MM

Capacity liter	Capacity hl	Ø mm	h1 mm	H mm	h2 mm	D1 mm	HV	Order No.
6,500	65.0	2,200	2,580	2,720	225	2,953	8xM24	FS-MO-220-1- 6500
7,400	74.0	2,200	2,830	2,970	225	3,141	8xM24	FS-MO-220-1- 7400
8,400	84.0	2,200	3,080	3,220	225	3,338	8xM24	FS-MO-220-1- 8400
9,200	92.0	2,200	3,330	3,470	225	3,541	8xM24	FS-MO-220-1- 9200
10,200	102.0	2,200	3,580	3,720	225	3,750	8xM24	FS-MO-220-1-10200
12,000	120.0	2,200	4,080	4,220	225	4,187	8xM24	FS-MO-220-1-12000
14,000	140.0	2,200	4,580	4,720	225	4,642	8xM24	FS-MO-220-1-14000
15,800	158.0	2,200	5,080	5,200	225	5,113	8xM24	FS-MO-220-1-15800
16,800	168.0	2,200	5,330	5,470	225	5,351	8xM24	FS-MO-220-1-16800
19,000	190.0	2,200	5,840	5,980	225	5,969	8xM24	FS-MO-220-1-19000
20,000	200.0	2,200	6,090	6,230	225	6,212	8xM24	FS-MO-220-1-20000

PRESSURE TANK FS-MO-1B Ø 2,400 MM

Capacity liter	Capacity hl	Ø mm	h1 mm	H mm	h2 mm	D1 mm	HV	Order No.
7,800	78.0	2,400	2,660	2,800	225	3,118	8xM24	FS-MO-240-1- 7800
8,900	89.0	2,400	2,910	3,050	225	3,301	8xM24	FS-MO-240-1- 8900
10,000	100.0	2,400	3,160	3,300	225	3,492	8xM24	FS-MO-240-1-10000
12,200	122.0	2,400	3,660	3,800	225	3,895	8xM24	FS-MO-240-1-12200
14,500	145.0	2,400	4,160	4,300	225	4,318	8xM24	FS-MO-240-1-14500
16,200	162.0	2,400	4,410	4,560	225	4,666	8xM24	FS-MO-240-1-16200
17,300	173.0	2,400	4,660	4,810	225	4,893	8xM24	FS-MO-240-1-17300
19,500	195.0	2,400	5,160	5,310	225	5,359	8xM24	FS-MO-240-1-19500
20,500	205.0	2,400	5,410	5,560	225	5,595	8xM24	FS-MO-240-1-20500
23,000	230.0	2,400	5,910	6,060	225	6,074	8xM24	FS-MO-240-1-23000
24,000	240.0	2,400	6,160	6,310	225	6,315	8xM24	FS-MO-240-1-24000
25,000	250.0	2,400	6,410	6,560	225	6,558	8xM24	FS-MO-240-1-25000

PRESSURE TANK FS-MO-1B Ø 2,600 MM

Capacity liter	Capacity hl	Ø mm	h1 mm	H mm	h2 mm	D1 mm	HV	Order No.
10,200	102.0	2,600	2,730	2,880	225	3,380	8 x M24	FS-MO-260-1-10200
11,500	115.0	2,600	2,980	3,130	225	3,562	8 x M24	FS-MO-260-1-11500
12,600	126.0	2,600	3,230	3,380	225	3,752	8 x M24	FS-MO-260-1-12600
14,000	140.0	2,600	3,480	3,630	225	3,949	8 x M24	FS-MO-260-1-14000
16,600	166.0	2,600	3,980	4,130	225	4,359	8 x M24	FS-MO-260-1-16600
18,000	180.0	2,600	4,230	4,380	225	4,571	8 x M24	FS-MO-260-1-18000
20,500	205.0	2,600	4,730	4,880	225	5,012	8 x M24	FS-MO-260-1-20500
22,000	220.0	2,600	4,980	5,130	225	5,238	8 x M24	FS-MO-260-1-22000
24,500	245.0	2,600	5,480	5,630	225	5,701	8 x M24	FS-MO-260-1-24500
26,000	260.0	2,600	5,730	5,880	225	5,936	8 x M24	FS-MO-260-1-26000
27,000	270.0	2,600	5,980	6,130	225	6,207	8 x M24	FS-MO-260-1-27000
28,500	285.0	2,600	6,230	6,380	225	6,444	10 x M24	FS-MO-260-1-28500
30,000	300.0	2,600	6,480	6,630	225	6,683	10 x M24	FS-MO-260-1-30000
32,500	325.0	2,600	6,980	7,130	225	7,164	10 x M24	FS-MO-260-1-32500

PRESSURE TANK FS-MO-1B Ø 2,800 MM

Capacity liter	Capacity hl	Ø mm	h1 mm	H mm	h2 mm	D1 mm	HV	Order No.
12,100	121.0	2,800	2,835	2,985	225	3,567	8 x M24	FS-MO-280-1-12100
13,600	136.0	2,800	3,085	3,235	225	3,745	8 x M24	FS-MO-280-1-13600
15,000	150.0	2,800	3,335	3,485	225	3,931	8 x M24	FS-MO-280-1-15000
16,500	165.0	2,800	3,585	3,735	225	4,124	8 x M24	FS-MO-280-1-16500
18,200	182.0	2,800	3,835	3,985	225	4,323	8 x M24	FS-MO-280-1-18200
21,200	212.0	2,800	4,335	4,485	225	4,735	8 x M24	FS-MO-280-1-21200
22,800	228.0	2,800	4,385	4,735	225	4,952	8 x M24	FS-MO-280-1-22800
24,200	242.0	2,800	4,835	4,985	225	5,168	8 x M24	FS-MO-280-1-24200
25,800	258.0	2,800	5,085	5,235	225	5,389	8 x M24	FS-MO-280-1-25800
27,400	274.0	2,800	5,335	5,485	225	5,614	8 x M30	FS-MO-280-1-27400
29,000	290.0	2,800	5,585	5,735	225	5,844	8 x M30	FS-MO-280-1-29000
32,000	320.0	2,800	6,085	6,235	225	6,311	8 x M30	FS-MO-280-1-32000
33,500	335.0	2,800	6,335	6,485	225	6,548	8 x M30	FS-MO-280-1-33500
35,000	350.0	2,800	6,585	6,735	225	6,786	8 x M30	FS-MO-280-1-35000
36,500	365.0	2,800	6,835	6,985	225	7,026	8 x M30	FS-MO-280-1-36500
38,000	380.0	2,800	7,085	7,235	225	7,267	8 x M30	FS-MO-280-1-38000
39,500	395.0	2,800	7,325	7,475	225	7,523	10 x M30	FS-MO-280-1-39500
41,000	410.0	2,800	7,585	7,735	225	7,779	10 x M30	FS-MO-280-1-41000

PRESSURE TANK FS-MO-1B Ø 3,000 MM

Capacity liter	Capacity hl	Ø mm	h1 mm	H mm	h2 mm	D1 mm	HV	Order No.
14,300	143.0	3,000	2,850	3,000	225	3,695	8xM30	FS-MO-300-1-14300
16,000	160.0	3,000	3,100	3,250	225	3,867	8xM30	FS-MO-300-1-16000
18,000	180.0	3,000	3,350	3,500	225	4,046	8xM30	FS-MO-300-1-18000
19,500	195.0	3,000	3,600	3,750	225	4,233	8xM30	FS-MO-300-1-19500
21,500	215.0	3,000	3,850	4,000	225	4,427	8xM30	FS-MO-300-1-21500
23,000	230.0	3,000	4,100	4,250	225	4,625	8xM30	FS-MO-300-1-23000
25,000	250.0	3,000	4,350	4,500	225	4,829	8xM30	FS-MO-300-1-25000
28,500	285.0	3,000	4,850	5,000	225	5,248	8xM30	FS-MO-300-1-28500
30,000	300.0	3,000	5,100	5,250	225	5,463	8xM30	FS-MO-300-1-30000
32,000	320.0	3,000	5,350	5,500	225	5,686	8xM30	FS-MO-300-1-32000
33,800	338.0	3,000	5,600	5,750	225	5,937	8xM30	FS-MO-300-1-33800
35,500	355.0	3,000	5,850	6,000	225	6,187	10xM30	FS-MO-300-1-35500
37,200	372.0	3,000	6,100	6,250	225	6,414	10xM30	FS-MO-300-1-37200
39,000	390.0	3,000	6,350	6,500	225	6,645	10xM30	FS-MO-300-1-39000
42,500	425.0	3,000	6,850	7,000	225	7,112	10xM30	FS-MO-300-1-42500
44,200	442.0	3,000	7,100	7,250	225	7,349	10xM30	FS-MO-300-1-44200
46,000	460.0	3,000	7,350	7,500	225	7,588	10xM30	FS-MO-300-1-46000
47,800	478.0	3,000	7,600	7,750	225	7,826	10xM30	FS-MO-300-1-47800
49,500	495.0	3,000	7,850	8,000	225	8,066	10xM30	FS-MO-300-1-49500





Pressure tank FS-M0-3B

The FS-M0-3B is suitable for high pressure fermentation and maturing up to a working pressure of 3 bar. This version is the classic model for fermentation or maturing in the two tank method.

Besides for beer the 3 bar pressure tank is also suitable for fizzy lemonade, soft drinks and any other sparkling fluid that is under pressure.

APPLICATION RANGE (PRESSURE RANGE UP TO 3.0 BAR)

- Fermentation
- Maturation
- Storage

Ideal for

- Beer
- All kinds of beverages
- Food
- Plant construction
- Industry





STANDARD EQUIPMENT FOR PRESSURE TANK FS-MO-3B

- For pressure application up to max. 3.0 bar
- Tank shell made of stainless steel AISI304 (V2A), IIIc / III d
- Tank bottom made of stainless steel AISI304 (V2A), surface IIIc / III d
- Tank top made of stainless steel AISI304 (V2A), surface IIIc / III d
- Surface outside marbled or brushed
- Ladder safety bow (from 2,000 mm tank height upwards)
- Free-standing on welded-on box-shaped legs
- Made in compliance with pressure equipment guidelines 2014 / 68 / EU

Sampling

- Weld-on thread NW 10 DIN 11851 (for the installation of the sample tap)

Filling dome at 280 liter (2,8 hl)

- Filling dome NW 400 with flap lid manhole

From 600 liter (6,0 hl) upwards

- Welded stable manhole neck 340x400 mm, door with swivelling handle and toggle nut

Cleaning pipe from 600 liter (6,0 hl) upwards

- Cleaning spray head, drill hole 360° with spray head holder, including cleaning pipe, connection thread NW 40 DIN 11851

Bottom outlet

- Vaulted dimensionally stable tank bottom with outlet pipe drawn forward, outlet NW 40 DIN 11851

Type plate

- Mounted on tank

Safety valve

- Set to 3.0 bar working pressure, mounted on tank top

DIMENSIONS OF PRESSURE FS-MO-3B

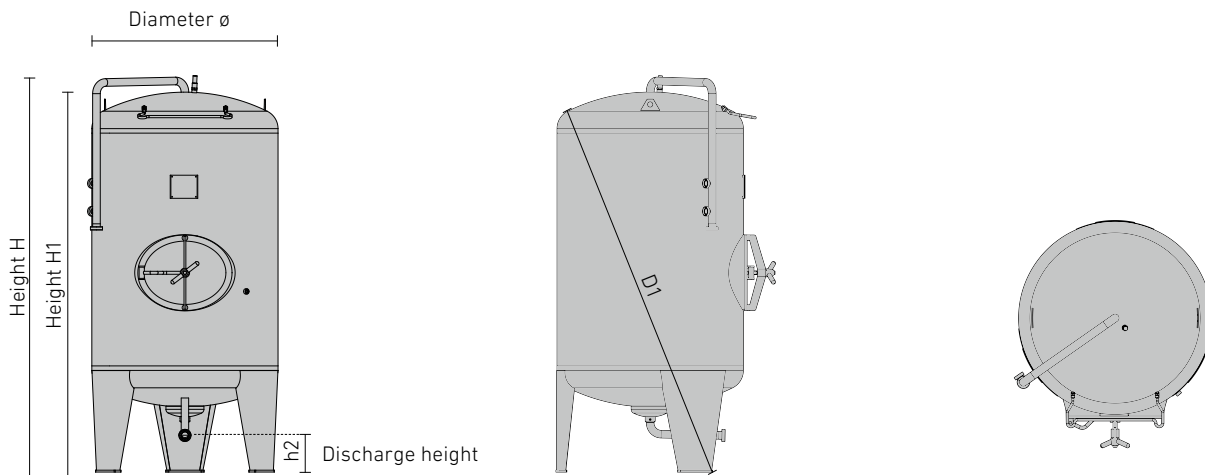

PRESSURE TANK FS-MO-3B Ø 630 MM

Capacity liter	Capacity hl	ø mm	h1 mm	H mm	h2 mm	D1 mm	Order No.
280	2.8	630	1,255	1,555	225	1,614	FD-063-3-280

PRESSURE TANK FS-MO-3B Ø 1,000 MM

Capacity liter	Capacity hl	ø mm	h1 mm	H mm	h2 mm	D1 mm	Order No.
600	6.0	1,000	1,390	1,540	225	1,670	FS-MO-100-3- 600
750	7.5	1,000	1,578	1,728	225	1,841	FS-MO-100-3- 750
950	9.5	1,000	1,825	1,975	225	1,985	FS-MO-100-3- 950
1,150	11.5	1,000	2,075	2,225	225	2,210	FS-MO-100-3- 1150
1,350	13.5	1,000	2,325	2,475	225	2,440	FS-MO-100-3- 1350
1,500	15.0	1,000	2,575	2,725	225	2,680	FS-MO-100-3- 1500
1,750	17.5	1,000	2,867	3,017	225	2,950	FS-MO-100-3- 1750
1,900	19.0	1,000	3,075	3,225	225	3,137	FS-MO-100-3- 1900
2,100	21.0	1,000	3,325	3,475	225	3,384	FS-MO-100-3- 2100

PRESSURE TANK FS-MO-3B Ø 1,200 MM

Capacity liter	Capacity hl	ø mm	h1 mm	H mm	h2 mm	D1 mm	Order No.
1,450	14.5	1,200	1,897	2,047	225	2,135	FS-MO-120-3-1450
1,800	18.0	1,200	2,222	2,392	225	2,415	FS-MO-120-3-1800
2,000	20.0	1,200	2,397	2,547	225	2,560	FS-MO-120-3-2000
2,400	24.0	1,200	2,762	2,912	225	2,910	FS-MO-120-3-2400
2,550	25.5	1,200	2,897	3,047	225	3,030	FS-MO-120-3-2550
2,800	28.0	1,200	3,147	3,297	225	3,221	FS-MO-120-3-2800
3,100	31.0	1,200	3,397	3,547	225	3,401	FS-MO-120-3-3100

PRESSURE TANK FS-MO-3B Ø 1,400 MM

Capacity liter	Capacity hl	Ø mm	h1 mm	H mm	h2 mm	D1 mm	Order No.
2,100	21.0	1,400	2,017	2,167	225	2,153	FS-MO-140-3-2100
2,400	24.0	1,400	2,222	2,372	225	2,314	FS-MO-140-3-2400
2,850	28.5	1,400	2,517	2,667	225	2,589	FS-MO-140-3-2850
3,000	30.0	1,400	2,617	2,767	225	2,689	FS-MO-140-3-3000
3,200	32.0	1,400	2,767	2,917	225	2,819	FS-MO-140-3-3200
3,600	36.0	1,400	3,017	3,167	225	3,055	FS-MO-140-3-3600
4,000	40.0	1,400	3,267	3,417	225	3,295	FS-MO-140-3-4000
4,300	43.0	1,400	3,517	3,667	225	3,537	FS-MO-140-3-4300
4,700	47.0	1,400	3,767	3,917	225	3,780	FS-MO-140-3-4700
5,100	51.0	1,400	4,017	4,167	225	4,025	FS-MO-140-3-5100

PRESSURE TANK FS-MO-3B Ø 1,600 MM

Capacity liter	Capacity hl	Ø mm	h1 mm	H mm	h2 mm	D1 mm	Order No.
3,050	30.5	1,600	2,275	2,425	225	2,488	FS-MO-160-3-3050
3,500	35.0	1,600	2,525	2,675	225	2,701	FS-MO-160-3-3500
4,000	40.0	1,600	2,775	2,925	225	2,838	FS-MO-160-3-4000
4,500	45.0	1,600	3,007	3,157	225	3,055	FS-MO-160-3-4500
5,000	50.0	1,600	3,257	3,407	225	3,295	FS-MO-160-3-5000
5,500	55.0	1,600	3,507	3,657	225	3,537	FS-MO-160-3-5500
6,000	60.0	1,600	3,757	3,907	225	3,780	FS-MO-160-3-6000
6,500	65.0	1,600	4,007	4,157	225	4,025	FS-MO-160-3-6500

PRESSURE TANK FS-MO-3B Ø 1,800 MM

Capacity liter	Capacity hl	Ø mm	h1 mm	H mm	h2 mm	D1 mm	Order No.
4,000	40.0	1,800	2,387	2,537	225	2,667	FS-MO-180-3-4000
4,700	47.0	1,800	2,637	2,787	225	2,874	FS-MO-180-3-4700
5,300	53.0	1,800	2,887	3,037	225	3,088	FS-MO-180-3-5300
5,900	59.0	1,800	3,137	3,287	225	3,313	FS-MO-180-3-5900
6,500	65.0	1,800	3,387	3,537	225	3,542	FS-MO-180-3-6500
7,100	71.0	1,800	3,637	3,787	225	3,776	FS-MO-180-3-7100
7,800	78.0	1,800	3,887	4,037	225	4,014	FS-MO-180-3-7800
8,400	84.0	1,800	4,137	4,287	225	4,254	FS-MO-180-3-8400

PRESSURE TANK FS-MO-3B Ø 2,000 MM

Capacity liter	Capacity hl	Ø mm	h1 mm	H mm	h2 mm	D1 mm	Order No.
5,200	52.0	2,000	2,487	2,637	225	2,707	FS-MO-200-3- 5200
6,000	60.0	2,000	2,737	2,887	225	2,909	FS-MO-200-3- 6000
6,800	68.0	2,000	2,987	3,137	225	3,118	FS-MO-200-3- 6800
7,500	75.0	2,000	3,237	3,387	225	3,338	FS-MO-200-3- 7500
8,300	83.0	2,000	3,487	3,637	225	3,560	FS-MO-200-3- 8300
9,100	91.0	2,000	3,737	3,887	225	3,790	FS-MO-200-3- 9100
9,900	99.0	2,000	3,887	4,137	225	4,025	FS-MO-200-3- 9900
10,600	106.0	2,000	4,237	4,387	225	4,263	FS-MO-200-3-10600

PRESSURE TANK FS-MO-3B Ø 2,200 MM

Capacity liter	Capacity hl	Ø mm	h1 mm	H mm	h2 mm	D1 mm	HV	Order No.
6,500	65.0	2,200	2,590	2,740	225	2,953	8xM24	FS-MO-220-3- 6500
7,500	75.0	2,200	2,840	2,990	225	3,141	8xM24	FS-MO-220-3- 7500
8,400	84.0	2,200	3,090	3,240	225	3,338	8xM24	FS-MO-220-3- 8400
9,300	93.0	2,200	3,340	3,490	225	3,541	8xM24	FS-MO-220-3- 9300
10,200	102.0	2,200	3,590	3,740	225	3,750	8xM24	FS-MO-220-3- 10200
12,100	121.0	2,200	4,090	4,240	225	4,187	8xM24	FS-MO-220-3- 12100
14,000	140.0	2,200	4,590	4,740	225	4,642	8xM24	FS-MO-220-3- 14000
15,000	150.0	2,200	4,840	5,240	225	5,113	8xM24	FS-MO-220-3- 15000
16,000	160.0	2,200	5,090	5,490	225	5,351	8xM24	FS-MO-220-3- 16000
17,000	170.0	2,200	5,340	5,630	225	5,462	8xM24	FS-MO-220-3- 17000
18,800	188.0	2,200	5,840	6,130	225	5,969	8xM24	FS-MO-220-3- 18800
20,500	205.0	2,200	6,340	6,630	225	6,462	8xM24	FS-MO-220-3- 20500

PRESSURE TANK FS-MO-3B Ø 2,400 MM

Capacity liter	Capacity hl	Ø mm	h1 mm	H mm	h2 mm	D1 mm	HV	Order No.
8,000	80.0	2,400	2,610	2,760	225	3,118	8xM24	FS-MO-240-3- 8000
9,200	92.0	2,400	2,860	3,010	225	3,301	8xM24	FS-MO-240-3- 9200
10,300	103.0	2,400	3,110	3,260	225	3,492	8xM24	FS-MO-240-3- 10300
12,500	125.0	2,400	3,610	3,760	225	3,895	8xM24	FS-MO-240-3- 12500
14,500	145.0	2,400	4,110	4,260	225	4,318	8xM24	FS-MO-240-3- 14500
15,800	158.0	2,400	4,360	4,510	225	4,568	8xM24	FS-MO-240-3- 15800
17,000	170.0	2,400	4,610	4,760	225	4,818	8xM24	FS-MO-240-3- 17000
19,200	192.0	2,400	5,110	5,260	225	5,318	8xM24	FS-MO-240-3- 19200
20,400	204.0	2,400	5,360	5,510	225	5,568	8xM24	FS-MO-240-3- 20400
22,500	225.0	2,400	5,860	6,010	225	6,068	8xM24	FS-MO-240-3- 22500
23,500	235.0	2,400	6,110	6,260	225	6,318	8xM24	FS-MO-240-3- 23500
24,800	248.0	2,400	6,360	6,510	225	6,568	8xM24	FS-MO-240-3- 24800

PRESSURE TANK FS-MO-3B Ø 2,600 MM

Capacity liter	Capacity hl	Ø mm	h1 mm	H mm	h2 mm	D1 mm	HV	Order No.
9,900	99.0	2,600	2,800	2,880	225	3,380	8xM24	FS-MO-260-3- 9900
11,200	112.0	2,600	3,050	3,130	225	3,562	8xM24	FS-MO-260-3- 11200
12,500	125.0	2,600	3,330	3,380	225	3,752	8xM24	FS-MO-260-3- 12500
13,600	136.0	2,600	3,550	3,630	225	3,949	8xM24	FS-MO-260-3- 13600
16,500	165.0	2,600	4,050	4,130	225	4,359	8xM24	FS-MO-260-3- 16500
17,500	175.0	2,600	4,300	4,380	225	4,571	8xM24	FS-MO-260-3- 17500
20,300	203.0	2,600	4,800	4,880	225	5,012	8xM24	FS-MO-260-3- 20300
21,500	215.0	2,600	5,050	5,130	225	5,238	8xM24	FS-MO-260-3- 21500
24,200	242.0	2,600	5,550	5,630	225	5,701	8xM24	FS-MO-260-3- 24200
25,500	255.0	2,600	5,800	5,880	225	5,936	8xM24	FS-MO-260-3- 25500
27,000	270.0	2,600	6,050	6,130	225	6,207	8xM24	FS-MO-260-3- 27000
28,000	280.0	2,600	6,300	6,380	225	6,444	10xM24	FS-MO-260-3- 28000
29,500	295.0	2,600	6,550	6,630	225	6,683	10xM24	FS-MO-260-3- 29500
32,000	320.0	2,600	7,050	7,130	225	7,164	10xM24	FS-MO-260-3- 32000

PRESSURE TANK FS-MO-3B Ø 2,800 MM

Capacity liter	Capacity hl	Ø mm	h1 mm	H mm	h2 mm	D1 mm	HV	Order No.
11,800	118.0	2,800	2,945	3,095	225	3,567	8xM24	FS-MO-280-3-11800
13,400	134.0	2,800	3,195	3,305	225	3,745	8xM24	FS-MO-280-3-13400
15,000	150.0	2,800	3,445	3,555	225	3,931	8xM24	FS-MO-280-3-15000
16,500	165.0	2,800	3,695	3,805	225	4,124	8xM24	FS-MO-280-3-16500
18,000	180.0	2,800	3,945	4,055	225	4,323	8xM24	FS-MO-280-3-18000
21,000	210.0	2,800	4,445	4,555	225	4,735	8xM24	FS-MO-280-3-21000
22,500	225.0	2,800	4,695	4,805	225	4,952	8xM24	FS-MO-280-3-22500
24,000	240.0	2,800	4,945	5,055	225	5,168	8xM24	FS-MO-280-3-24000
25,500	255.0	2,800	5,195	5,305	225	5,389	8xM24	FS-MO-280-3-25500
27,000	270.0	2,800	5,445	5,555	225	5,614	8xM24	FS-MO-280-3-27000
28,500	285.0	2,800	5,695	5,805	225	5,844	8xM30	FS-MO-280-3-28500
31,500	315.0	2,800	6,195	6,305	225	6,311	8xM30	FS-MO-280-3-31500
33,000	330.0	2,800	6,445	6,555	225	6,548	8xM30	FS-MO-280-3-33000
34,500	345.0	2,800	6,695	6,805	225	6,786	8xM30	FS-MO-280-3-34500
36,000	360.0	2,800	6,945	7,055	225	7,026	8xM30	FS-MO-280-3-36000
37,500	375.0	2,800	7,195	7,305	225	7,267	8xM30	FS-MO-280-3-37500
39,000	390.0	2,800	7,445	7,555	225	7,523	10xM30	FS-MO-280-3-39000
40,800	408.0	2,800	7,695	7,805	225	7,779	10xM30	FS-MO-280-3-40800

PRESSURE TANK FS-MO-3B Ø 3,000 MM

Capacity liter	Capacity hl	Ø mm	h1 mm	H mm	h2 mm	D1 mm	HV	Order No.
14,100	141.0	3,000	2,970	3,120	225	3,695	8xM30	FS-MO-300-3-14100
16,000	160.0	3,000	3,220	3,370	225	3,867	8xM30	FS-MO-300-3-16000
17,500	175.0	3,000	3,470	3,620	225	4,046	8xM30	FS-MO-300-3-17500
19,500	195.0	3,000	3,720	3,870	225	4,233	8xM30	FS-MO-300-3-19500
21,000	210.0	3,000	3,970	4,120	225	4,427	8xM30	FS-MO-300-3-21000
23,000	230.0	3,000	4,220	4,370	225	4,625	8xM30	FS-MO-300-3-23000
24,500	245.0	3,000	4,470	4,620	225	4,829	8xM30	FS-MO-300-3-24500
26,500	265.0	3,000	4,720	4,870	225	5,039	8xM30	FS-MO-300-3-26500
28,000	280.0	3,000	4,970	5,120	225	5,248	8xM30	FS-MO-300-3-28000
30,000	300.0	3,000	5,220	5,370	225	5,463	8xM30	FS-MO-300-3-30000
31,500	315.0	3,000	5,470	5,620	225	5,686	8xM30	FS-MO-300-3-31500
33,500	335.0	3,000	5,720	5,870	225	5,937	8xM30	FS-MO-300-3-33500
35,000	350.0	3,000	5,970	6,120	225	6,187	8xM30	FS-MO-300-3-35000
37,000	370.0	3,000	6,220	6,370	225	6,414	10xM30	FS-MO-300-3-37000
38,500	385.0	3,000	6,420	6,570	225	6,645	10xM30	FS-MO-300-3-38500
40,500	405.0	3,000	6,670	6,820	225	6,879	10xM30	FS-MO-300-3-40500
42,000	420.0	3,000	6,970	7,120	225	7,112	10xM30	FS-MO-300-3-42000
44,000	440.0	3,000	7,220	7,370	225	7,349	10xM30	FS-MO-300-3-44000
45,500	455.0	3,000	7,470	7,620	225	7,588	10xM30	FS-MO-300-3-45500
47,500	475.0	3,000	7,720	7,870	225	7,826	10xM30	FS-MO-300-3-47500
49,000	490.0	3,000	7,970	8,120	225	8,066	12xM30	FS-MO-300-3-49000



Pressure tank FS-MO-8B

The pressure tank FS-MO-8B is mostly used in the production of sparkling wine. By default all our pressure tanks come with an AISI 316 tank top and are designed for 8 bar working pressure. They are manufactured in best Speidel quality complying with the stringent guidelines for pressure devices 2014 / 68 / EU.

We are certified to DIN EN ISO 3834-2 and AD 2000 HP0. Before delivery, each tank is individually tested and approved by the TÜV, Germany's Technical Control Board. We make sure by all possible means that you can be sure!

APPLICATION RANGE (PRESSURE RANGE UP TO 8.0 BAR)

- Fermentation
- Maturation
- Storage

Ideal for

- Sparkling wine
- All kinds of beverages

TÜV-tested with documentation,
welded manhole with swivelling handle
and standardised tank bottoms





STANDARD EQUIPMENT FOR PRESSURE TANK FOR SPARKLING WINE FS-MO-8B

- For pressure application up to max. 8.0 bar
- Tank top made of AISI 316 stainless steel, surface IIIc (2B)
- Tank shell made of AISI 304 stainless steel, surface IIIc (2B), marbled outside
- Tank bottom made of AISI 304 stainless steel, surface IIIc (2B)
- Vaulted, stable tank top with lifting lugs and ladder safety bow
- Free-standing on welded-on box-shaped legs
- Type plate
- Safety valve
- Manufactured complying with the stringent guidelines for pressure devices 2014 / 68 / EU

Sampling

- Weld-on thread NW 20 DIN 11851 with sealing cap

Manhole

- Welded stable manhole neck 340 x 440 mm with reinforcement ring
- Door with swivelling handle and toggle nut











Racking outlet

- Reinforced plate with drilled hole \varnothing 48 mm (to hold flap valve or weld-on thread NW 50 DIN 11851)

Bottom outlet

- Vaulted, stable tank bottom, in bottom centre with forward drawn discharge pipe and outlet with thread NW 50 DIN 11851

SET-UP EXAMPLE FOR PRESSURE TANK FOR SPARKLING WINE FS-MO-8B

	Item	Order No.
	Stainless steel pressure tank FS-MO-140-8B-5200 liter	
	<ul style="list-style-type: none"> · h1 = 4,172 mm, $H_{\text{compl.}} = 4,172 \text{ mm (h1)} + 150 \text{ mm (cleaning pipe)}$ + approx. 100 mm (height compensation) = 4,422 mm · Standard equipment as on page 123 	FS-MO-140-8-5200
	Sampling (page 176)	
	· With sampling tap NW 20 DIN 11851	65583
	Racking outlet (page 172)	
	<ul style="list-style-type: none"> · Welded gland with thread NW 50 DIN 11851 · With bevel seat valve NW 50 DIN 11851 on request 	KA-120D 80738
	Bottom outlet (page 172)	
	· With disc valve NW 50 DIN 11851	64945
	Cleaning pipe (page 186)	
	<ul style="list-style-type: none"> · Removable cleaning spray head NW 40, H = + 150 mm · Perforation 360° with clip fastener · Including spray head holder with cleaning pipe pulled down to operating height · Disc valve NW 40 DIN 11851 	RL-041A RL-040A 61375
	Pipes (page 186)	
	<ul style="list-style-type: none"> · Ventilation pipe: stainless steel pipeline NW 25 pulled down to operating height, connection NW 25 DIN 11851 · Safety fittings consisting of pressure manometer, spring-loaded safety valve, nitrogen transfer and bevel seat valve DN 25 DIN 11851 · Disc valve NW 40 DIN 11851 	EL-100A SA-100A 61375
	Heating and cooling jacket (page 128)	
	<ul style="list-style-type: none"> · Double jacket B4.1 m² with welded gland thread G 1" for the connection to available warm water / cold water source · Version 1, layout 78, connection position F11 	F11
	Temperature measurement (page 180)	
	<ul style="list-style-type: none"> · Bi-metal dial thermometer ø 100 mm, measuring range -20 °C to +60 °C · Length = 125 mm · Including welded-on sleeve for thermometer 	TM-140F
	Fill level (page 177)	
	<ul style="list-style-type: none"> · Mounted fill level indicator NW 10 DIN 11851 with liter scale · Closed version – connection between fill level indicator and cleaning pipe 	FS-130I
	Adjustable feet (page 184)	
	· With adjustable feet for tank legs (H = + approx. 100 mm)	46125
	TÜV-fees (fees for German Technical Control Board)	TÜV-001

DIMENSIONS OF PRESSURE TANK FOR SPARKLING WINE FS-MO-8B

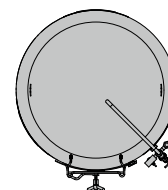
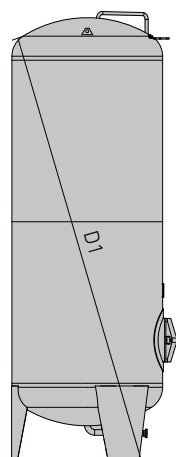
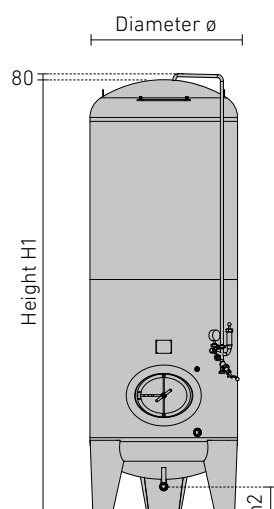

Legend

h1 = Tank height

h2 = Discharge height

h6 = Shell height

D1 = Installation height

H_{compl.} = Total height

Capacity liter	\varnothing mm	h1 mm	h2 mm	h6 mm	D1 mm	HV	Order No.
1,000	1,000	1,955	225	1,000	2,030	3 x M20	FS-MO-100-8- 1000
1,200	1,000	2,205	225	1,250	2,250	3 x M20	FS-MO-100-8- 1200
1,400	1,000	2,455	225	1,500	2,480	3 x M20	FS-MO-100-8- 1400
1,600	1,000	2,705	225	1,750	2,720	3 x M20	FS-MO-100-8- 1600
1,800	1,000	2,955	225	2,000	2,950	3 x M20	FS-MO-100-8- 1800
2,000	1,000	3,205	225	2,250	3,190	3 x M20	FS-MO-100-8- 2000
2,150	1,000	3,455	225	2,500	3,430	3 x M20	FS-MO-100-8- 2150
1,500	1,200	2,057	225	1,000	2,170	3 x M20	FS-MO-120-8- 1500
1,800	1,200	2,307	225	1,250	2,390	3 x M20	FS-MO-120-8- 1800
2,100	1,200	2,557	225	1,500	2,610	3 x M20	FS-MO-120-8- 2100
2,400	1,200	2,807	225	1,750	2,840	3 x M20	FS-MO-120-8- 2400
2,600	1,200	3,057	225	2,000	3,070	3 x M20	FS-MO-120-8- 2600
2,900	1,200	3,307	225	2,250	3,310	3 x M20	FS-MO-120-8- 2900
3,200	1,200	3,557	225	2,500	3,540	3 x M20	FS-MO-120-8- 3200
2,200	1,400	2,172	225	1,000	2,350	6 x M20	FS-MO-140-8- 2100
2,600	1,400	2,422	225	1,250	2,560	6 x M20	FS-MO-140-8- 2600
3,000	1,400	2,672	225	1,500	2,780	6 x M20	FS-MO-140-8- 3000
3,400	1,400	2,922	225	1,750	3,000	6 x M20	FS-MO-140-8- 3400
3,700	1,400	3,172	225	2,000	3,230	6 x M20	FS-MO-140-8- 3700
4,100	1,400	3,422	225	2,250	3,460	6 x M20	FS-MO-140-8- 4100
4,500	1,400	3,672	225	2,500	3,690	6 x M20	FS-MO-140-8- 4500
4,900	1,400	3,922	225	2,750	3,930	6 x M20	FS-MO-140-8- 4900
5,200	1,400	4,172	225	3,000	4,160	6 x M20	FS-MO-140-8- 5200
3,000	1,600	2,277	225	1,000	2,520	8 x M20	FS-MO-160-8- 3000
3,500	1,600	2,527	225	1,250	2,720	8 x M20	FS-MO-160-8- 3500
4,000	1,600	2,777	225	1,500	2,930	8 x M20	FS-MO-160-8- 4000
4,500	1,600	3,027	225	1,750	3,150	8 x M20	FS-MO-160-8- 4500
5,000	1,600	3,277	225	2,000	3,370	8 x M20	FS-MO-160-8- 5000
5,500	1,600	3,527	225	2,250	3,600	8 x M20	FS-MO-160-8- 5500
6,000	1,600	3,777	225	2,500	3,820	8 x M20	FS-MO-160-8- 6000
6,500	1,600	4,027	225	2,750	4,060	8 x M20	FS-MO-160-8- 6500
7,000	1,600	4,277	225	3,000	4,290	8 x M20	FS-MO-160-8- 7000
10,000	1,600	5,777	225	4,500	5,740	8 x M20	FS-MO-160-8-10000



Stainless steel fermentation egg Black Eye

We have developed a stainless steel fermenting egg that combines the advantages of the egg shape with the advantages of a stainless steel tank and a unique design. The Black Eye looks like a space satellite from the outside and provides a gentle and well controllable fermentation inside. Due to its unique shape, the

yeast can circulate smoothly during the fermentation phase. In science it is assumed that this free circulation is an advantage for the fermentation process and thus for the entire aroma spectrum. Thanks to the perfect welding seams and the highly smooth inner walls, the fermenting chamber is also very easy to clean.

APPLICATION RANGE (PRESSURELESS)

- Fermentation
- Maturation
- Storage
- Mixing
- Processes

Ideal for

- Beer
- Juice
- Must
- Spirits
- Non-alcoholic beverages
- Alcoholic beverages



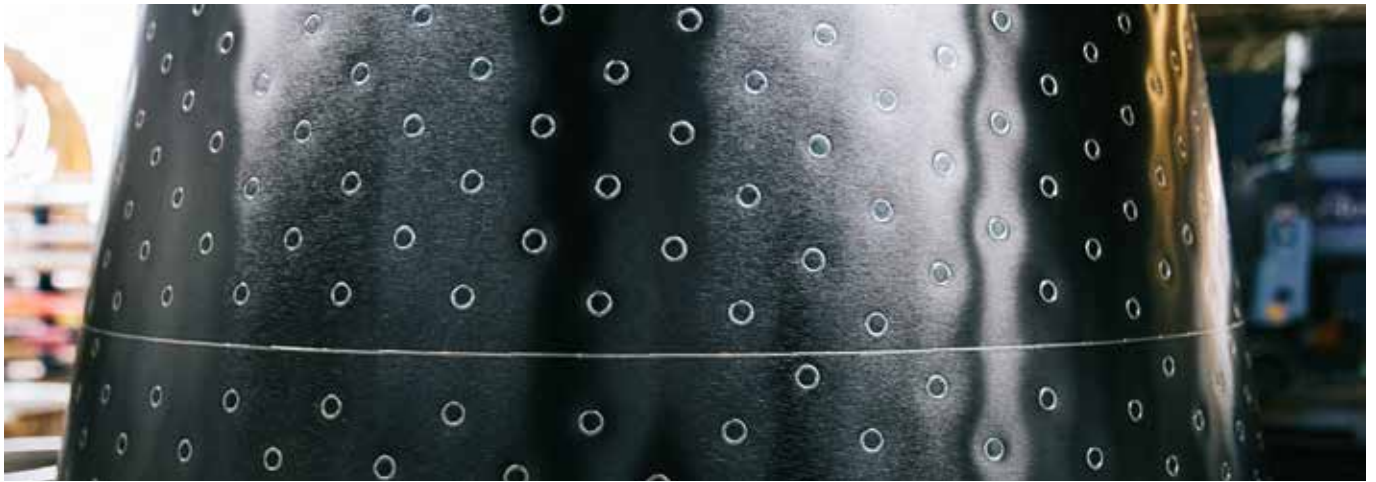

STANDARD EQUIPMENT FOR BLACK EYE

- For non-pressurized use
- Tank shell and tank bottom made of AISI 304 stainless steel, surface IIIId (2R), brushed outside
- Tank top made of AISI 316 stainless steel, surface IIIId (2R), brushed outside
- DOM NW400 centered in the middle of the tank top with flap lid with venting nozzle NW50 DIN 11851
- Free-standing base tank on three welded-on legs

Sampling

- Weld-on thread NW 10 DIN 11851 with sealing cap (for the installation of sampling tap)

Racking outlet

- Weld-on thread NW50 DIN 11851

Double jacket

- Laser-welded double jacket for cooling with two connection pieces G1" with external thread, color: black

Temperature measurement

- Weld-on thread NW10 DIN 11851

Bottom outlet

- Vaulted, stable tank bottom, in bottom centre with forward drawn discharge pipe and outlet with thread NW 50 DIN 11851

DIMENSIONS OF STAINLESS STEEL FERMENTATION EGG

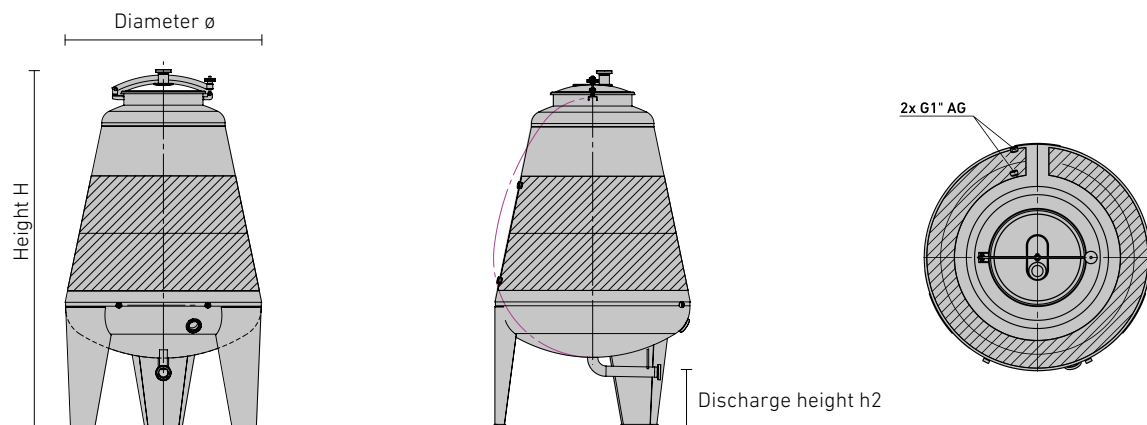

Capacity	Capacity	ø	Height H	h2	Order No.
liter	hl	mm	mm	mm	
625	6.25	1,000	1,829	278	FS-M0-100-S V1147
1,000	10.00	1,200	2,022	286	FS-M0-120-S V1179

Always the right temperature

The controlled temperature regulation is a key factor in the process of fermentation nowadays. In this regard our double jackets which are factory fitted by laser procedure help tremendously.



Double jackets for cooling or heating

The double jacket is moulded on the outside of the tank shell and transfers the heat or cold onto the medium inside the tank. This way it is impossible for the content of the tank to get in contact with the heating / cooling medium itself.

The double jackets have been dimensioned and standardised after many years of testing. They are ready to be connected to a pipeline system with appropriate heat / cooling source. When installing the feed pipes attention needs to be paid to the use of sufficiently sized pipe bores which ensure perfect cooling or heating. The double jackets are designed for an operating pressure of 2.5 to 6.0 bar. The dimension of the pump, the dimension of the cross sections of the feed pipes as well as the proportioning of the pressures and volume flows depend on the type of application / utilisation, the kind of heater / cooler used and the total capacity.

Note concerning water quality:

In case the cooling / heating medium is water, an appropriate analysis of the water should be carried out before the initial operation. In order to avoid corrosion damage the water needs to be treated and monitored regularly. Safeguard your system with filters against the infiltration of dirt or iron particles. There must be no air in the system because air facilitates the generation of microbes, sedimentary depositions and corrosion.

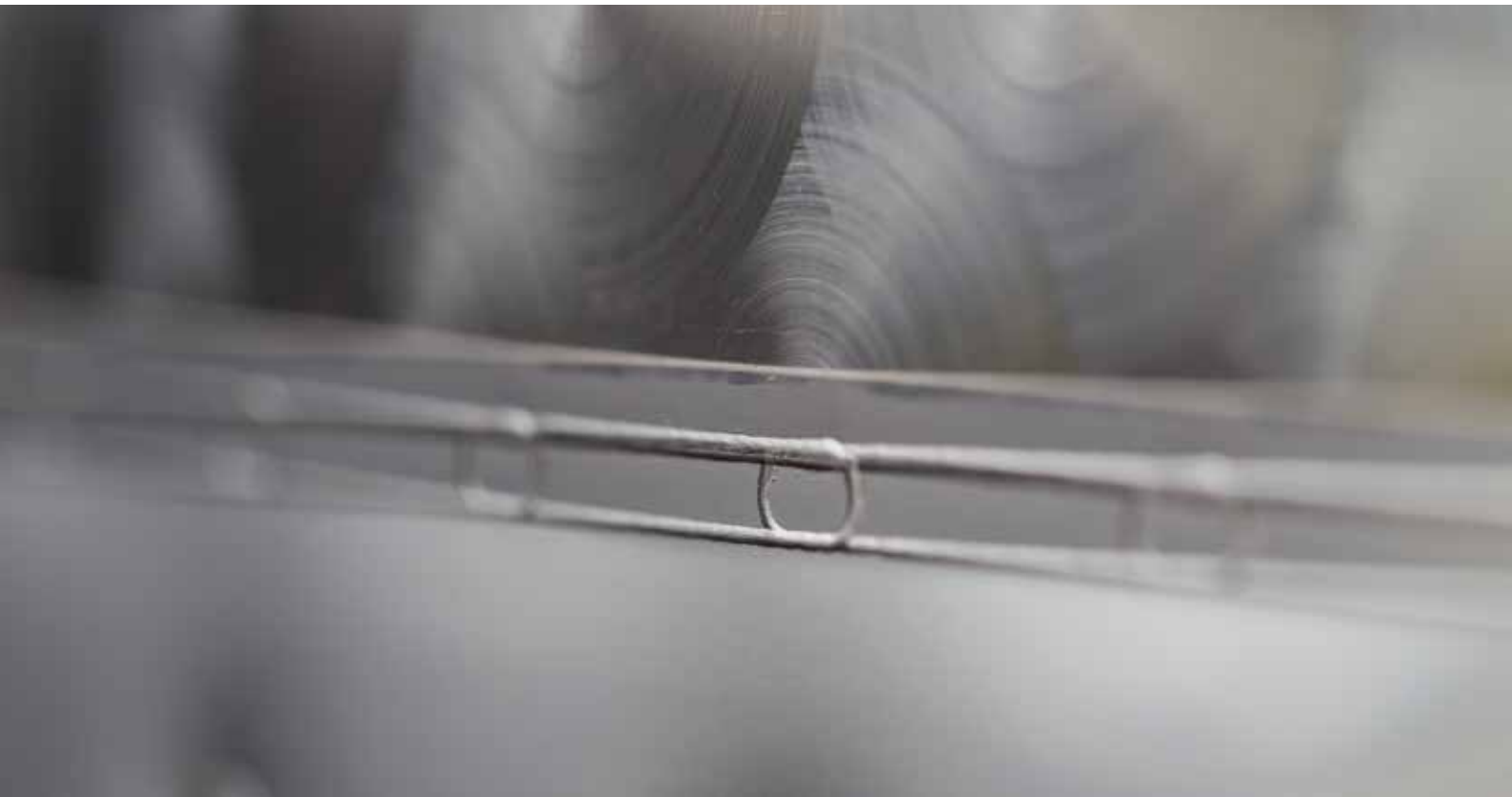



OPEN TOP TANKS

CLOSED TANKS

TANKS FOR MIXING, TRANSPORTATION AND STORAGE

PRESSURE TANKS/BLACK EYE

STANDARD EQUIPMENT FOR DOUBLE JACKETS

- Laser welded double jacket (data in accordance with chart)
- Water connections AG G 1" (BSP) (selection subject to column "connection position")
- Weld-on thread NW 10 DIN 11851 for temperature measurement (position located above sampling)

DOUBLE JACKET LAYOUTS

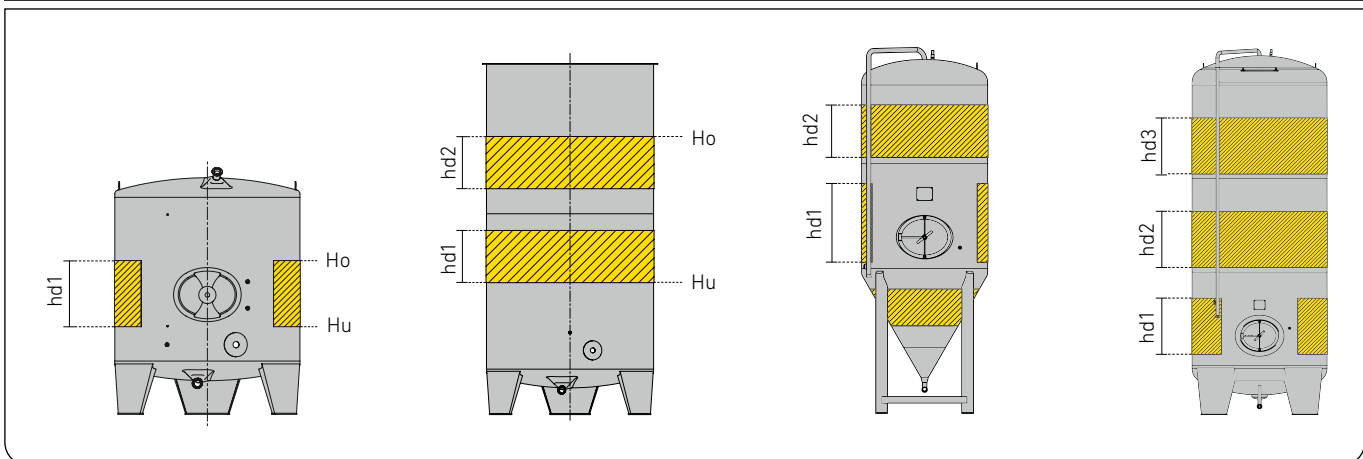

COOLING AND HEATING

ACCESSORIES

Double jackets

LAYOUTS DOUBLE JACKET FO

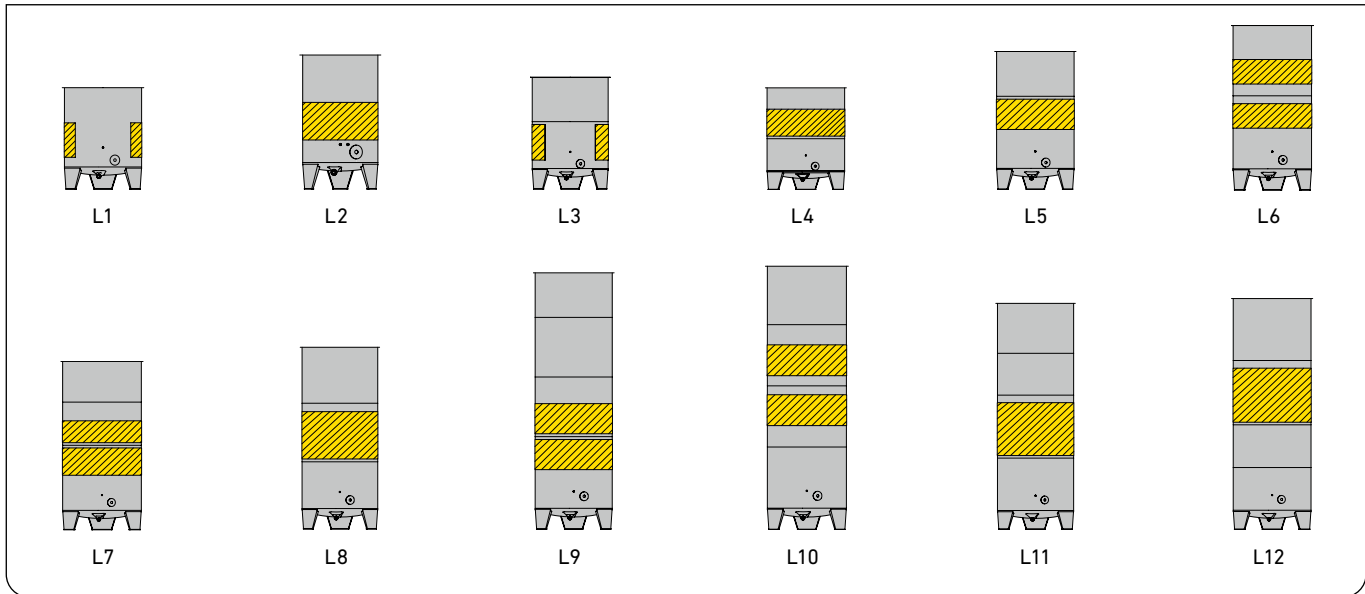

DOUBLE JACKET FO Ø 820–1,600 MM

Capacity liter	Tank-Ø mm	Version	Connection		Layout	Surface m ²	hd1 mm	hd2 mm	Ho %	Hu %	Order No. mounted
			position	Layout							
530	820	1	A1 : A2	L1	0.8	500	-	61	15	1A1 : 1A2	
*530	820	2	B1 : B2	L2	1.2	500	-	74	29	2B1 : 2B2	
675	820	1	A1 : A2	L1	1.1	750	-	65	9	1A1 : 1A2	
*675	820	2	B1 : B2	L2	1.2	500	-	64	27	2B1 : 2B2	
910	820	1	A1 : A2	L3	1.1	750	-	49	8	1A1 : 1A2	
*910	820	2	B1 : B2	L5	1.2	500	-	48	21	2B1 : 2B2	
1.100	1.000	1	A1 : A2	L1	1.2	625	-	61	18	1A1 : 1A2	
*1.100	1.000	2	B1 : B2	L2	1.5	500	-	61	26	2B1 : 2B2	
1.600	1.200	1	A1 : A2	L1	1.6	625	-	61	18	1A1 : 1A2	
*1.600	1.200	2	B1 : B2	L2	1.8	500	-	61	27	2B1 : 2B2	
2.200	1.400	1	A1 : A2	L1	2.0	625	-	61	18	1A1 : 1A2	
*2.200	1.400	2	B1 : B2	L2	2.2	500	-	41	18	2B1 : 2B2	
3.300	1.400	1	A1 : A2	L3	2.4	750	-	50	16	1A1 : 1A2	
*3.300	1.400	2	B1 : B2	L5	2.2	500	-	58	35	2B1 : 2B2	
*3.300	1.400	3	B1 : B2	L5	2.7	625	-	50	21	3B1 : 3B2	
2.850	1.600	1	A1 : A2	L1	2.4	625	-	61	19	1A1 : 1A2	
*2.850	1.600	2	B1 : B2	L2	2.5	500	-	61	27	2B1 : 2B2	
3.850	1.600	1	A1 : A2	L3	2.9	750	-	53	14	1A1 : 1A2	
3.850	1.600	2	B1 : B2	L5	2.5	500	-	65	40	2B1 : 2B2	
4.800	1.600	1	A1 : A2	L3	2.9	750	-	47	16	1A1 : 1A2	
4.800	1.600	2	B1 : B2	L5	3.1	625	-	62	37	2B1 : 2B2	
5.800	1.600	1	A1 : A2	L3	3.8	1,000	-	49	15	1A1 : 1A2	
5.800	1.600	2	B1 : B2	L5	3.1	625	-	52	31	2B1 : 2B2	
5.800	1.600	3	B3 : B4	L6	4.9	500	500	79	35	3B3 : 3B4	
6.800	1.600	1	B1 : B2	L8	4.9	1,000	-	62	33	1B1 : 1B2	
7.700	1.600	1	B1 : B2	L8	4.9	1,000	-	55	29	1B1 : 1B2	
7.700	1.600	2	B1 : B2	L8	4.9	1,000	-	67	42	2B1 : 2B2	
8.700	1.600	1	B1 : B2	L8	6.2	1,250	-	68	40	1B1 : 1B2	
9.700	1.600	1	B3 : B4	L9	6.2	625	625	46	18	1B3 : 1B4	
9.700	1.600	2	B3 : B4	L10	6.2	625	625	69	36	2B3 : 2B4	

* Version can only be chosen without manhole / mash door

CONNECTION POSITIONS DOUBLE JACKET FO

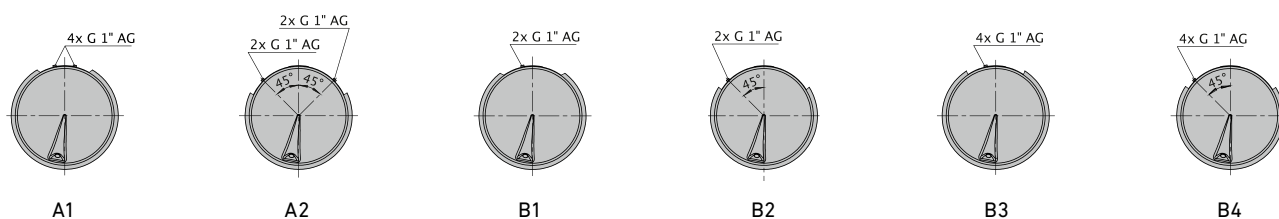

DOUBLE JACKET FO Ø 1,800–2,000 MM

Capacity liter	Tank- \varnothing mm	Version	Connection position	Layout Surface	hd1 mm	hd2 mm	Ho %	Hu %	Order No. mounted	
3,700	1,800	1	A1 : A2	L1	2.8	625	-	62	19	1A1 : 1A2
*3,700	1,800	2	B1 : B2	L2	3.5	625	-	68	28	2B1 : 2B2
4,900	1,800	1	A1 : A2	L3	3.3	750	-	53	15	1A1 : 1A2
4,900	1,800	2	B1 : B2	L4	3.5	625	-	78	46	2B1 : 2B2
6,100	1,800	1	A1 : A2	L3	4.5	1,000	-	52	11	1A1 : 1A2
6,100	1,800	2	B1 : B2	L5	4.2	750	-	62	32	2B1 : 2B2
7,400	1,800	1	A1 : A2	L3	4.5	1,000	-	49	16	1A1 : 1A2
7,400	1,800	2	B3 : B4	L6	5.5	500	500	77	29	2B3 : 2B4
8,600	1,800	1	B3 : B4	L7	6.3	625	500	62	27	1B3 : 1B4
8,600	1,800	2	B1 : B2	L8	5.6	1,000	-	62	33	2B1 : 2B2
9,800	1,800	1	B3 : B4	L7	6.3	625	500	55	23	1B3 : 1B4
9,800	1,800	2	B1 : B2	L8	6.9	1,250	-	61	29	2B1 : 2B2
11,000	1,800	1	B1 : B2	L8	6.9	1,250	-	65	37	1B1 : 1B2
11,000	1,800	2	B3 : B4	L7	7.0	625	625	56	23	2B3 : 2B4
12,200	1,800	1	B1 : B2	L11	6.9	1,250	-	57	29	1B1 : 1B2
12,200	1,800	2	B1 : B2	L12	6.9	1,250	-	69	43	2B1 : 2B2
12,200	1,800	3	B3 : B4	L10	8.1	750	750	69	23	3B3 : 3B4
4,500	2,000	1	A1 : A2	L1	3.2	625	-	62	20	1A1 : 1A2
*4,500	2,000	2	B1 : B2	L2	3.9	625	-	70	29	2B1 : 2B2
6,000	2,000	1	A1 : A2	L3	3.8	750	-	53	16	1A1 : 1A2
6,000	2,000	2	B1 : B2	L4	3.9	625	-	78	47	2B1 : 2B2
7,600	2,000	1	A1 : A2	L3	5.1	1,000	-	53	13	1A1 : 1A2
7,600	2,000	2	B1 : B2	L5	4.7	750	-	64	32	2B1 : 2B2
9,100	2,000	1	A1 : A2	L3	6.3	1,250	-	52	10	1A1 : 1A2
9,100	2,000	2	B3 : B4	L6	6.2	500	500	78	31	2B3 : 2B4
10,600	2,000	1	B3 : B4	L7	7.8	625	625	66	27	1B3 : 1B4
10,600	2,000	2	B1 : B2	L8	7.8	1,250	-	70	34	2B1 : 2B2
12,200	2,000	1	B3 : B4	L7	7.8	625	625	60	24	1B3 : 1B4
12,200	2,000	2	B1 : B2	L8	7.8	1,250	-	61	30	2B1 : 2B2
13,800	2,000	1	B3 : B4	L7	9.3	500	1,000	60	24	1B3 : 1B4
15,200	2,000	1	B3 : B4	L9	10.0	625	1,000	54	19	1B3 : 1B4
15,200	2,000	2	B3 : B4	L10	10.0	1,000	625	69	29	2B3 : 2B4

* Version can only be chosen without manhole / mash door

LAYOUTS DOUBLE JACKET FO



L70



L71

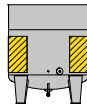

L72

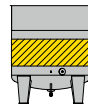

L73

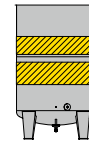

L74

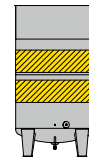

L75

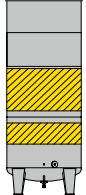

L76

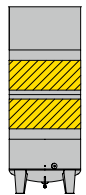

L77

CONNECTION POSITIONS DOUBLE JACKET FO

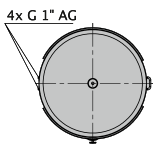

A3

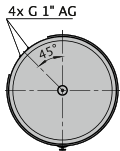

A4

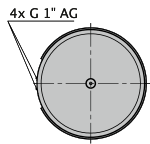

B5

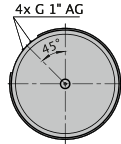

B6

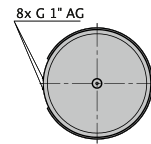

B7

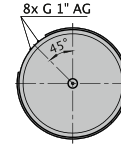

B8

DOUBLE JACKET FO Ø 2,200–2,400 MM

Capacity liter	Tank- \varnothing mm	Version	Connection position	Layout	Surface m ²	hd1 mm	hd2 mm	Ho %	Hu %	Order No. mounted
6,000	2,200	1	A3 : A4	L70	4.1 / 3.7	750	-	63	19	1A3 : 1A4
*6,000	2,200	2	B5 : B6	L71	4.2	625	-	66	30	2B5 : 2B6
8,000	2,200	1	A3 : A4	L72	5.5 / 5.0	1,000	-	60	14	1A3 : 1A4
*8,000	2,200	2	B5 : B6	L73	5.0	750	-	57	23	2B5 : 2B6
9,800	2,200	1	A3 : A4	L72	6.8 / 6.2	1,250	-	58	12	1A3 : 1A4
9,800	2,200	2	B5 : B6	L73	6.7	1,000	-	56	19	2B5 : 2B6
11,700	2,200	1	B7 : B8	L74	7.5	625	500	75	28	1B7 : 1B8
13,500	2,200	1	B7 : B8	L75	8.4	625	625	68	25	1B7 : 1B8
15,500	2,200	1	B7 : B8	L75	10.0	750	750	67	22	1B7 : 1B8
17,500	2,200	1	B7 : B8	L75	11.7	750	1,000	65	20	1B7 : 1B8
19,000	2,200	1	B7 : B8	L76	12.5	625	1,250	61	18	1B7 : 1B8
7,200	2,400	1	A3 : A4	L70	4.6 / 4.1	750	-	63	20	1A3 : 1A4
7,200	2,400	2	B5 : B6	L71	4.6	625	-	67	31	2B5 : 2B5
9,500	2,400	1	A3 : A4	L72	6.1 / 5.5	1,000	-	60	15	1A3 : 1A4
9,500	2,400	2	B5 : B6	L73	5.5	750	-	58	24	2B5 : 2B5
11,500	2,400	1	A3 : A4	L72	7.6 / 6.8	1,250	-	58	13	1A3 : 1A4
11,500	2,400	2	B5 : B6	L73	7.4	1,000	-	56	20	2B5 : 2B6
14,000	2,400	1	B7 : B8	L74	8.3	625	500	75	29	1B7 : 1B8
16,000	2,400	1	B7 : B8	L75	10.1	625	750	72	25	1B7 : 1B8
18,500	2,400	1	B7 : B8	L75	11.0	750	750	67	23	1B7 : 1B8
20,500	2,400	1	B7 : B8	L75	12.9	750	1,000	65	20	1B7 : 1B8
23,000	2,400	1	B7 : B8	L76	13.8	625	1,250	61	17	1B7 : 1B8
23,000	2,400	2	B7 : B8	L77	14.7	1,000	1,000	71	26	2B7 : 2B8
25,000	2,400	1	B7 : B8	L76	14.7	750	1,250	56	17	1B7 : 1B8
25,000	2,400	2	B7 : B8	L77	14.7	1,000	1,000	71	32	2B7 : 2B8

* Version can only be chosen without manhole / mash door

LAYOUTS DOUBLE JACKET FO

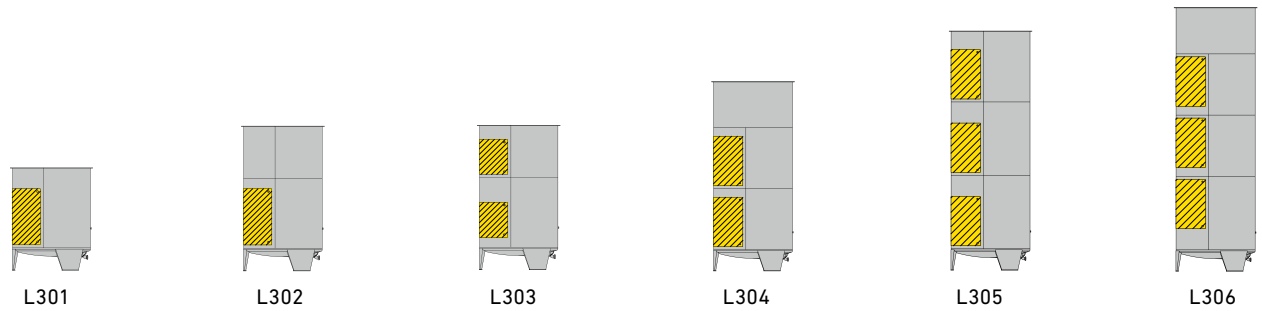

CONNECTION POSITIONS DOUBLE JACKET FO

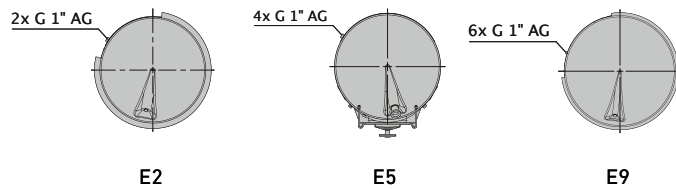

DOUBLE JACKET FO Ø 820–2,000 MM

Capacity	Tank-Ø	Version	Connection position	Layout	Surface	hd1	hd2	hd3	Ho	Hu	Order No.
liter	mm				m ²	mm	mm	mm	%	%	mounted
530	820	3	E2	301	0.6	625	-	-	70	15	3E2
675	820	3	E2	301	0.7	750	-	-	68	14	3E2
910	820	3	E2	302	0.9	1,000	-	-	68	15	3E2
1,100	1,000	3	E2	301	1.1	1,000	-	-	80	12	3E2
1,600	1,200	3	E2	301	1.3	1,000	-	-	76	12	3E2
2,200	1,400	3	E2	301	1.6	1,000	-	-	76	13	3E2
3,300	1,400	4	E5	303	2.0	625	625	-	89	14	4E5
2,850	1,600	3	E2	301	1.9	1,000	-	-	77	15	3E2
3,850	1,600	3	E5	303	2.4	625	625	-	88	17	3E5
4,800	1,600	3	E5	303	2.8	750	750	-	85	9	3E5
5,800	1,600	4	E5	303	3.8	1,000	1,000	-	88	8	4E5
6,800	1,600	2	E5	304	3.8	1,000	1,000	-	69	7	2E5
7,700	1,600	3	E5	304	3.8	1,000	1,000	-	76	15	3E5
8,700	1,600	2	E9	305	5.7	1,000	1,000	1,000	92	5	2E9
9,700	1,600	3	E9	306	5.7	1,000	1,000	1,000	80	12	3E9
3,700	1,800	3	E2	301	2.2	1,000	-	-	77	15	3E2
4,900	1,800	3	E5	303	2.8	625	625	-	88	14	3E5
6,100	1,800	3	E5	303	3.4	750	750	-	86	15	3E5
7,400	1,800	3	E5	303	4.4	1,000	1,000	-	88	12	3E5
8,600	1,800	3	E5	304	4.4	1,000	1,000	-	69	-	3E5
9,800	1,800	3	E9	305	6.1	1,000	1,000	750	97	12	3E9
11,000	1,800	3	E9	305	6.6	1,000	1,000	1,000	82	13	3E9
12,200	1,800	4	E9	306	6.6	1,000	1,000	1,000	80	14	4E9
4,500	2,000	3	E2	301	2.5	1,000	-	-	77	15	3E2
6,000	2,000	3	E5	303	3.2	625	625	-	88	17	3E5
7,600	2,000	3	E5	303	3.8	750	750	-	86	9	3E5
9,100	2,000	3	E5	303	5.0	1,000	1,000	-	88	8	3E5
10,600	2,000	3	E9	305	6.9	1,000	1,000	750	96	-	3E9
12,200	2,000	3	E9	305	6.9	1,000	1,000	750	97	15	3E9
13,800	2,000	2	E9	305	7.5	1,000	1,000	1,000	92	5	2E9
15,200	2,000	3	E9	306	7.5	1,000	1,000	1,000	80	12	3E9

All prices in Euro, subject to change, ex works, plus VAT.

LAYOUT DOUBLE JACKETS FS1-MO, FS-MO, AS1-MO, AS-MO, MS-MO

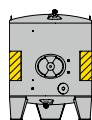

L13

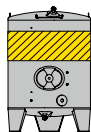

L14

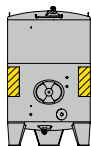

L15

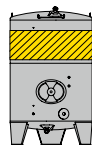

L16

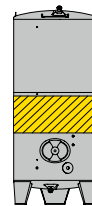

L17

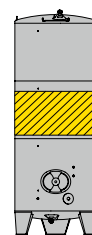

L18

DOUBLE JACKETS FS-MO, AS-MO Ø 820–1,200 MM, MS-MO 1,000–1,200 MM

Capacity	Tank-ø	Version	Connection position	Layout	Surface	hd1	hd2	Ho	Hu	Order No.
liter	mm				m ²	mm	mm	%	%	mounted
320	820	1	A1 : A2	L13	0.5	333	-	73	21	1A1 : 1A2
525	820	1	A1 : A2	L13	0.8	500	-	74	25	1A1 : 1A2
625	820	1	A1 : A2	L13	0.8	500	-	55	14	1A1 : 1A2
750	820	1	A1 : A2	L13	0.8	500	-	52	18	1A1 : 1A2
750	820	2	B1 : B2	L14	0.8	333	-	80	58	2B1 : 2B2
1,000	820	1	A1 : A2	L15	1.1	750	-	46	8	1A1 : 1A2
1,000	820	2	B1 : B2	L16	0.8	333	-	70	53	2B1 : 2B2
1,000	820	3	B1 : B2	L16	1.2	500	-	78	53	3B1 : 3B2
650	1,000	1	A1 : A2	L13	1.0	500	-	71	16	1A1 : 1A2
850	1,000	1	A1 : A2	L13	1.0	500	-	67	24	1A1 : 1A2
1,050	1,000	1	A1 : A2	L13	1.0	500	-	60	24	1A1 : 1A2
1,250	1,000	1	A1 : A2	L13	1.0	500	-	60	30	1A1 : 1A2
1,250	1,000	2	B1 : B2	L14	1.0	333	-	73	53	2B1 : 2B2
1,400	1,000	1	A1 : A2	L15	1.0	500	-	53	26	1A1 : 1A2
1,400	1,000	2	B1 : B2	L16	1.0	333	-	78	60	2B1 : 2B2
1,550	1,000	1	B1 : B2	L17	1.0	333	-	63	39	1B1 : 1B2
1,550	1,000	2	A1 : A2	L15	1.0	500	-	42	17	2A1 : 2A2
1,800	1,000	1	B1 : B2	L17	1.5	500	-	63	42	1B1 : 1B2
1,800	1,000	2	B1 : B2	L16	1.5	500	-	79	58	2B1 : 2B2
2,000	1,000	1	B1 : B2	L17	1.5	500	-	58	38	1B1 : 1B2
2,000	1,000	2	B1 : B2	L16	1.5	500	-	73	52	2B1 : 2B2
2,200	1,000	1	B1 : B2	L17	1.9	625	-	52	31	1B1 : 1B2
2,200	1,000	2	B1 : B2	L16	1.9	625	-	69	48	2B1 : 2B2
2,350	1,000	1	B1 : B2	L17	1.9	625	-	48	28	1B1 : 1B2
2,350	1,000	2	B1 : B2	L16	1.9	625	-	72	52	2B1 : 2B2
2,500	1,000	1	B1 : B2	L18	1.9	625	-	62	43	1B1 : 1B2
1,000	1,200	1	A1 : A2	L13	1.3	500	-	71	16	1A1 : 1A2
1,300	1,200	1	A1 : A2	L13	1.3	500	-	67	24	1A1 : 1A2
1,550	1,200	1	A1 : A2	L13	1.3	500	-	60	25	1A1 : 1A2
1,800	1,200	1	A1 : A2	L13	1.3	500	-	60	30	1A1 : 1A2
1,800	1,200	2	B1 : B2	L14	1.2	333	-	73	53	2B1 : 2B2
2,000	1,200	1	A1 : A2	L15	1.3	500	-	55	27	1A1 : 1A2
2,000	1,200	2	B1 : B2	L17	1.2	333	-	70	51	2B1 : 2B2
2,100	1,200	1	A1 : A2	L15	1.3	500	-	52	26	1A1 : 1A2
2,100	1,200	2	B1 : B2	L17	1.2	333	-	67	49	2B1 : 2B2
2,350	1,200	1	A1 : A2	L15	1.6	625	-	45	16	1A1 : 1A2
2,350	1,200	2	B1 : B2	L16	1.8	500	-	76	53	2B1 : 2B2
2,500	1,200	1	A1 : A2	L15	2.0	750	-	50	17	1A1 : 1A2
2,500	1,200	2	B1 : B2	L17	1.8	500	-	62	39	2B1 : 2B2
2,650	1,200	1	A1 : A2	L15	2.0	750	-	47	17	1A1 : 1A2
2,650	1,200	2	B1 : B2	L16	1.8	500	-	70	47	2B1 : 2B2
3,000	1,200	1	A1 : A2	L15	2.0	750	-	43	16	1A1 : 1A2
3,000	1,200	2	B1 : B2	L16	1.8	500	-	74	54	2B1 : 2B2
3,200	1,200	1	B1 : B2	L17	2.3	625	-	52	31	1B1 : 1B2

CONNECTION POSITIONS DOUBLE JACKETS FS-MO, AS-MO, MS-MO

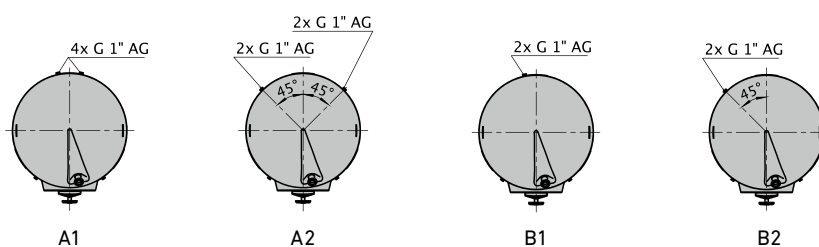

DOUBLE JACKETS FS-MO, AS-MO Ø 1,200–1,600 MM, MS-MO 1,200–1,600 MM

Capacity liter	Tank-Ø mm	Version	Connection position	Layout Surface	hd1 m ²	hd2 mm	Ho %	Hu %	Order No.	
									mounted	
3,200	1,200	2	B1 : B2	L16	2.3	625	-	69	48	2B1 : 2B2
3,500	1,200	1	B1 : B2	L17	2.3	625	-	48	28	1B1 : 1B2
3,500	1,200	2	B1 : B2	L16	2.3	625	-	73	52	2B1 : 2B2
3,750	1,200	1	B1 : B2	L18	2.3	625	-	59	41	1B1 : 1B2
4,000	1,200	1	B1 : B2	L18	2.8	750	-	59	38	1B1 : 1B2
4,300	1,200	1	B1 : B2	L18	3.7	1.000	-	61	36	1B1 : 1B2
4,600	1,200	1	B1 : B2	L18	3.7	1.000	-	64	40	1B1 : 1B2
1,400	1,400	1	A1 : A2	L13	1.6	500	-	76	17	1A1 : 1A2
1,750	1,400	1	A1 : A2	L13	1.6	500	-	70	24	1A1 : 1A2
2,150	1,400	1	A1 : A2	L13	1.6	500	-	61	25	1A1 : 1A2
2,500	1,400	1	A1 : A2	L13	1.6	500	-	60	30	1A1 : 1A2
2,500	1,400	2	B1 : B2	L14	2.2	500	-	87	53	2B1 : 2B2
2,850	1,400	1	A1 : A2	L15	1.6	500	-	53	27	1A1 : 1A2
2,850	1,400	2	B1 : B2	L16	2.2	500	-	90	60	2B1 : 2B2
3,000	1,400	1	A1 : A2	L15	2.0	625	-	47	16	1A1 : 1A2
3,000	1,400	2	B1 : B2	L16	2.2	500	-	80	53	2B1 : 2B2
3,200	1,400	1	A1 : A2	L15	2.0	625	-	47	18	1A1 : 1A2
3,200	1,400	2	B1 : B2	L16	2.2	500	-	78	53	2B1 : 2B2
3,600	1,400	1	A1 : A2	L15	2.0	625	-	45	20	1A1 : 1A2
3,600	1,400	2	B1 : B2	L16	2.2	500	-	70	47	2B1 : 2B2
4,000	1,400	1	A1 : A2	L16	2.4	750	-	43	15	1A1 : 1A2
4,000	1,400	2	B1 : B2	L15	2.2	500	-	73	52	2B1 : 2B2
4,400	1,400	1	B1 : B2	L17	2.7	625	-	52	31	1B1 : 1B2
4,400	1,400	2	B1 : B2	L16	2.7	625	-	70	48	2B1 : 2B2
4,750	1,400	1	B1 : B2	L17	2.7	625	-	48	28	1B1 : 1B2
4,750	1,400	2	B1 : B2	L16	2.7	625	-	73	52	2B1 : 2B2
5,100	1,400	1	B1 : B2	L18	3.2	750	-	63	41	1B1 : 1B2
5,500	1,400	1	B1 : B2	L18	3.2	750	-	59	38	1B1 : 1B2
5,850	1,400	1	B1 : B2	L18	4.3	1.000	-	62	36	1B1 : 1B2
6,300	1,400	1	B1 : B2	L18	4.3	1.000	-	64	40	1B1 : 1B2
6,700	1,400	1	B1 : B2	L18	4.3	1.000	-	60	37	1B1 : 1B2
1,800	1,600	1	A1 : A2	L13	1.9	500	-	70	17	1A1 : 1A2
2,300	1,600	1	A1 : A2	L13	1.9	500	-	66	25	1A1 : 1A2
2,800	1,600	1	A1 : A2	L13	1.9	500	-	60	25	1A1 : 1A2
3,300	1,600	1	A1 : A2	L13	1.9	500	-	53	24	1A1 : 1A2
3,800	1,600	1	A1 : A2	L15	2.9	750	-	53	15	1A1 : 1A2
3,800	1,600	2	B1 : B2	L16	2.5	500	-	89	60	2B1 : 2B2
4,200	1,600	1	A1 : A2	L15	2.9	750	-	47	13	1A1 : 1A2
4,200	1,600	2	B1 : B2	L16	3.1	625	-	85	53	2B1 : 2B2
4,800	1,600	1	A1 : A2	L15	2.9	750	-	47	17	1A1 : 1A2
4,800	1,600	1	B1 : B2	L16	3.1	625	-	86	58	2B1 : 2B2
5,200	1,600	2	A1 : A2	L15	2.9	750	-	43	15	1A1 : 1A2
5,200	1,600	1	B1 : B2	L16	3.1	625	-	78	52	2B1 : 2B2

LAYOUTS DOUBLE JACKETS FS-MO, AS-MO, MS-MO, FD-MBT

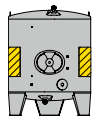

L13

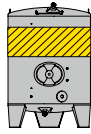

L14

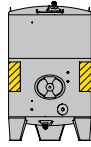

L15

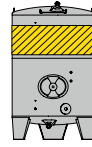

L16

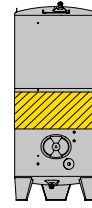

L17

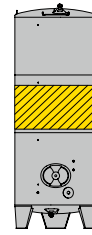

L18

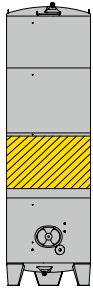

L19

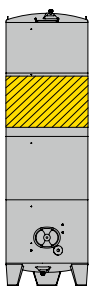

L20

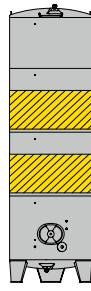

L21

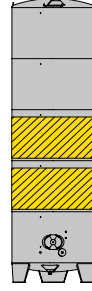

L22

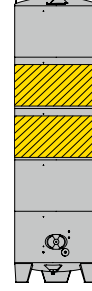

L23

DOUBLE JACKETS FS-MO, AS-MO Ø 1,600–1,800 MM, MS-MO 1,600–1,800 MM

Capacity	Tank-ø	Version	Connection position	Layout	Surface	hd1	hd2	Ho	Hu	Order No.
liter	mm				m ²	mm	mm	%	%	mounted
5,800	1,600	1	A1 : A2	L15	3.8	1,000	-	50	16	1A1 : 1A2
5,800	1,600	2	B1 : B2	L16	3.7	750	-	73	48	2B1 : 2B2
6,200	1,600	1	A1 : A2	L15	3.8	1,000	-	46	14	1A1 : 1A2
6,200	1,600	2	B1 : B2	L16	3.7	750	-	77	52	2B1 : 2B2
6,700	1,600	1	B1 : B2	L18	3.7	750	-	63	41	1B1 : 1B2
7,200	1,600	1	B1 : B2	L18	3.7	750	-	59	38	1B1 : 1B2
7,700	1,600	1	B1 : B2	L18	4.9	1,000	-	61	36	1B1 : 1B2
8,200	1,600	1	B1 : B2	L18	4.9	1,000	-	64	40	1B1 : 1B2
8,700	1,600	1	B1 : B2	L18	4.9	1,000	-	60	38	1B1 : 1B2
9,200	1,600	1	B1 : B2	L18	6.2	1,250	-	62	35	1B1 : 1B2
9,700	1,600	1	B1 : B2	L19	4.9	1,000	-	51	31	1B1 : 1B2
9,700	1,600	2	B1 : B2	L20	4.9	1,000	-	78	56	2B1 : 2B2
9,700	1,600	3	B3 : B4	L21	7.4	750	750	69	29	3B3 : 3B4
10,000	1,600	1	B1 : B2	L19	4.9	1,000	-	49	30	1B1 : 1B2
10,000	1,600	2	B1 : B2	L20	4.9	1,000	-	74	54	2B1 : 2B2
10,000	1,600	3	B3 : B4	L21	7.4	750	750	66	27	3B3 : 3B4
2,400	1,800	1	A1 : A2	L13	2.3	500	-	70	18	1A1 : 1A2
3,000	1,800	1	A1 : A2	L13	2.3	500	-	66	25	1A1 : 1A2
3,600	1,800	1	A1 : A2	L13	2.3	500	-	60	26	1A1 : 1A2
4,200	1,800	1	A1 : A2	L13	2.3	500	-	59	30	1A1 : 1A2
4,200	1,800	2	B1 : B2	L14	2.8	500	-	82	53	2B1 : 2B2
4,800	1,800	1	A1 : A2	L15	3.4	750	-	53	15	1A1 : 1A2
4,800	1,800	2	B1 : B2	L16	2.8	500	-	85	60	2B1 : 2B2
5,500	1,800	1	A1 : A2	L15	3.4	750	-	47	13	1A1 : 1A2
5,500	1,800	2	B1 : B2	L16	3.5	625	-	81	53	2B1 : 2B2
6,100	1,800	1	A1 : A2	L15	3.4	750	-	47	17	1A1 : 1A2
6,100	1,800	2	B1 : B2	L16	3.5	625	-	73	47	2B1 : 2B2
6,700	1,800	1	A1 : A2	L15	4.5	1,000	-	48	11	1A1 : 1A2
6,700	1,800	2	B1 : B2	L16	4.2	750	-	80	52	2B1 : 2B2
7,300	1,800	1	A1 : A2	L15	4.5	1,000	-	50	16	1A1 : 1A2
7,300	1,800	2	B1 : B2	L16	4.2	750	-	73	48	2B1 : 2B2
8,000	1,800	1	A1 : A2	L15	4.5	1,000	-	46	15	1A1 : 1A2
8,000	1,800	2	B1 : B2	L16	4.2	750	-	77	52	2B1 : 2B2

CONNECTION POSITIONS DOUBLE JACKETS FS-MO, AS-MO, MS-MO, FD-MBT

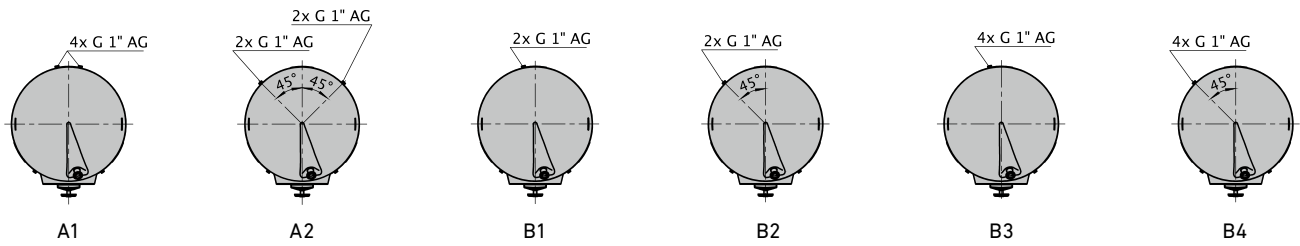

DOUBLE JACKETS FS-MO, AS-MO Ø 1,800–2,000 MM, MS-MO 1,800–2,000 MM, FD-MBT 2,000 MM

Capacity liter	Tank-ø mm	Version	Connection position	Layout	Surface m ²	hd1 mm	hd2 mm	Ho %	Hu %	Order No. mounted
8,500	1,800	1	B1 : B2	L18	4.2	750	-	63	41	1B1 : 1B2
9,200	1,800	1	B1 : B2	L18	5.6	1,000	-	65	38	1B1 : 1B2
9,800	1,800	1	B1 : B2	L18	5.6	1,000	-	61	36	1B1 : 1B2
10,400	1,800	1	B1 : B2	L18	5.6	1,000	-	64	40	1B1 : 1B2
11,000	1,800	1	B1 : B2	L18	6.9	1,250	-	66	37	1B1 : 1B2
11,600	1,800	1	B1 : B2	L18	6.9	1,250	-	62	36	1B1 : 1B2
12,200	1,800	1	B3 : B4	L21	8.3	750	750	69	29	1B3 : 1B4
12,800	1,800	1	B3 : B4	L21	8.3	750	750	65	27	1B3 : 1B4
13,500	1,800	1	B3 : B4	L21	8.3	750	750	67	31	1B3 : 1B4
14,000	1,800	1	B3 : B4	L21	8.3	750	750	69	29	1B3 : 1B4
14,700	1,800	1	B3 : B4	L21	11.0	1,000	1,000	70	28	1B3 : 1B4
15,300	1,800	1	B3 : B4	L21	11.0	1,000	1,000	67	27	1B3 : 1B4
3,000	2,000	1	A1 : A2	L13	2.6	500	-	69	19	1A1 : 1A2
3,800	2,000	1	A1 : A2	L13	2.6	500	-	55	26	1A1 : 1A2
4,600	2,000	1	A1 : A2	L13	2.6	500	-	60	26	1A1 : 1A2
5,200	2,000	1	A1 : A2	L13	3.8	750	-	60	17	1A1 : 1A2
5,300	2,000	1	A1 : A2	L13	3.8	750	-	60	17	1A1 : 1A2
6,000	2,000	1	A1 : A2	L15	3.8	750	-	53	15	1A1 : 1A2
6,000	2,000	2	B1 : B2	L16	3.9	625	-	91	59	1B1 : 1B2
6,100	2,000	1	A1 : A2	L15	3.8	750	-	53	15	1A1 : 1A2
6,100	2,000	2	B1 : B2	L16	3.9	625	-	91	59	2B1 : 2B2
6,700	2,000	1	A1 : A2	L15	3.8	750	-	47	13	1A1 : 1A2
6,700	2,000	2	B1 : B2	L16	3.9	625	-	91	59	1B1 : 1B2
6,800	2,000	1	A1 : A2	L15	3.8	750	-	47	13	1A1 : 1A2
6,800	2,000	2	B1 : B2	L16	3.9	625	-	81	53	2B1 : 2B2
7,600	2,000	1	A1 : A2	L15	5.1	1,000	-	53	12	1A1 : 1A2
7,600	2,000	2	B1 : B2	L16	4.7	750	-	78	47	2B1 : 2B2
8,300	2,000	1	A1 : A2	L15	5.1	1,000	-	48	12	1A1 : 1A2
8,300	2,000	2	B1 : B2	L16	4.7	750	-	80	52	1B1 : 1B2
8,400	2,000	1	A1 : A2	L15	5.1	1,000	-	48	12	1A1 : 1A2
8,400	2,000	2	B1 : B2	L16	4.7	750	-	80	52	2B1 : 2B2
9,200	2,000	1	A1 : A2	L15	5.1	1,000	-	52	19	1A1 : 1A2
9,200	2,000	2	B1 : B2	L16	6.2	1,000	-	81	48	2B1 : 2B2
9,800	2,000	1	A1 : A2	L15	5.1	1,000	-	48	17	1A1 : 1A2
9,800	2,000	1	B1 : B2	L16	6.2	1,000	-	83	52	1B1 : 1B2
10,000	2,000	1	A1 : A2	L15	5.1	1,000	-	48	17	1A1 : 1A2
10,000	2,000	2	B1 : B2	L16	6.2	1,000	-	83	52	2B1 : 2B2
10,600	2,000	1	B1 : B2	L18	6.2	1,000	-	63	34	1B1 : 1B2
11,400	2,000	1	B1 : B2	L18	6.2	1,000	-	65	28	1B1 : 1B2
12,200	2,000	1	B1 : B2	L18	6.2	1,000	-	61	36	1B1 : 1B2
13,000	2,000	1	B1 : B2	L18	6.2	1,000	-	63	40	1B1 : 1B2
13,700	2,000	1	B1 : B2	L18	7.8	1,250	-	65	38	1B1 : 1B2
14,500	2,000	1	B1 : B2	L18	7.8	1,250	-	62	36	1B3 : 1B4
15,200	2,000	1	B3 : B4	L21	9.3	750	750	69	29	1B3 : 1B4
16,000	2,000	1	B3 : B4	L21	9.3	750	750	66	27	1B3 : 1B4
16,800	2,000	1	B3 : B4	L21	9.3	750	750	67	31	1B3 : 1B4
17,500	2,000	1	B3 : B4	L21	12.4	1,000	1,000	69	29	1B3 : 1B4
18,300	2,000	1	B3 : B4	L21	12.4	1,000	1,000	70	28	1B3 : 1B4
19,000	2,000	1	B3 : B4	L21	12.4	1,000	1,000	67	27	1B3 : 1B4
20,000	2,000	1	B3 : B4	L22	12.4	1,000	1,000	57	22	1B3 : 1B4
20,000	2,000	2	B3 : B4	L23	12.4	1,000	1,000	76	41	2B3 : 2B4

LAYOUTS DOUBLE JACKETS FS1-MO, FS-MO, AS1-MO, AS-MO, MS-MO

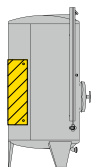

L201

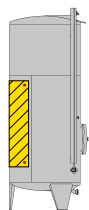

L202

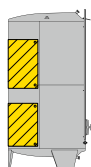

L203

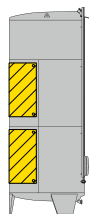

L204

DOUBLE JACKETS FS-MO, AS-MO Ø 820–1,200 MM, MS-MO 1,000–1,200 MM

Capacity	Tank-Ø	Version	Connection position	Layout	Surface	hd1	hd2	Ho	Hu	Order No.
liter	mm				m ²	mm	mm	%	%	mounted
320	820	2	E2	201	0.3	333	-	72	23	2E2
525	820	2	E2	201	0.6	625	-	73	15	2E2
625	820	2	E2	201	0.7	750	-	74	16	2E2
750	820	3	E2	201	0.7	750	-	68	20	3E2
1,000	820	4	E2	202	0.9	1,000	-	63	14	4E2
650	1,000	2	E2	201	0.6	500	-	70	18	2E2
850	1,000	2	E2	201	0.8	500	-	79	18	2E2
1,050	1,000	2	E2	201	1.1	1,000	-	80	12	2E2
1,250	1,000	3	E2	201	1.1	1,000	-	74	16	3E2
1,400	1,000	3	E2	202	1.1	1,000	-	66	15	3E2
1,550	1,000	3	E2	202	1.1	1,000	-	62	14	3E2
1,800	1,000	3	E5	203	1.6	750	750	90	9	3E5
2,000	1,000	3	E5	203	1.6	750	750	81	8	3E5
2,200	1,000	3	E5	203	2.2	1,000	1,000	88	6	3E5
2,350	1,000	3	E5	203	2.2	1,000	1,000	83	5	3E5
2,500	1,000	2	E5	204	2.2	1,000	1,000	73	5	2E5
1,000	1,200	2	E2	201	0.7	500	-	69	19	2E2
1,300	1,200	2	E2	201	1.0	750	-	78	19	2E2
1,550	1,200	2	E2	201	1.3	1,000	-	82	13	2E2
1,800	1,200	3	E2	201	1.3	1,000	-	74	17	3E2
2,000	1,200	3	E2	202	1.3	1,000	-	69	16	3E2
2,100	1,200	3	E2	202	1.3	1,000	-	66	16	3E2
2,350	1,200	3	E5	203	1.6	625	625	80	9	3E5
2,500	1,200	3	E5	203	1.6	625	625	87	8	3E5
2,650	1,200	3	E5	203	1.6	625	625	82	15	3E5
3,000	1,200	3	E5	203	2.6	1,000	1,000	89	7	3E5
3,200	1,200	3	E5	203	2.6	1,000	1,000	88	7	3E5

CONNECTION POSITIONS DOUBLE JACKETS FS-MO, AS-MO, MS-MO

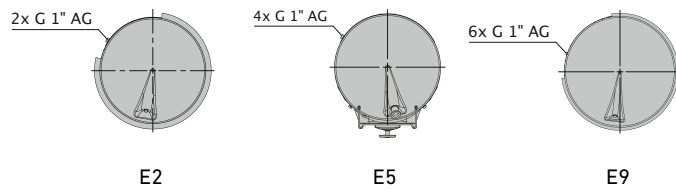

DOUBLE JACKETS FS-MO, AS-MO Ø 1,200–1,600 MM, MS-MO 1,200–1,600 MM

Capacity	Tank-Ø	Version	Connection position	Layout	Surface	hd1	hd2	hd3	Ho	Hu	Order No.
liter	mm				m ²	mm	mm	mm	%	%	mounted
3,500	1,200	3	E5	203	2.6	1,000	1,000	-	83	6	3E5
3,750	1,200	2	E5	204	2.6	1,000	1,000	-	73	9	2E5
4,000	1,200	2	E5	204	2.6	1,000	1,000	-	75	15	2E5
4,300	1,200	2	E9	205	3.9	1,000	1,000	1,000	92	5	2E9
4,600	1,200	2	E9	205	3.9	1,000	1,000	1,000	93	5	2E9
1,400	1,400	2	E2	201	0.8	500	-	-	68	20	2E2
1,750	1,400	2	E2	201	1.2	750	-	-	78	20	2E2
2,150	1,400	2	E2	201	1.6	1,000	-	-	79	14	2E2
2,500	1,400	3	E2	201	1.6	1,000	-	-	73	17	3E2
2,850	1,400	3	E2	202	1.6	1,000	-	-	66	16	3E2
3,000	1,400	3	E2	202	1.6	1,000	-	-	63	16	3E2
3,200	1,400	3	E5	203	2.0	625	625	-	80	9	3E5
3,600	1,400	3	E5	203	2.0	625	625	-	82	16	3E5
4,000	1,400	3	E5	203	2.4	750	750	-	79	8	3E5
4,400	1,400	3	E5	203	2.4	750	750	-	81	7	3E5
4,750	1,400	3	E5	203	3.2	1,000	1,000	-	82	6	3E5
5,100	1,400	2	E5	204	3.2	1,000	1,000	-	73	9	2E5
5,500	1,400	2	E5	204	3.2	1,000	1,000	-	70	16	2E5
5,850	1,400	2	E9	205	3.6	750	750	750	86	5	2E9
6,300	1,400	2	E9	205	3.6	750	750	750	86	5	2E9
6,700	1,400	2	E9	205	4.4	1,000	1,000	750	87	5	2E9
1,800	1,600	2	E2	201	1.2	625	-	-	79	22	2E2
2,300	1,600	2	E2	201	1.4	750	-	-	77	21	2E2
2,800	1,600	2	E2	201	1.9	1,000	-	-	78	15	2E2
3,300	1,600	2	E2	201	1.9	1,000	-	-	74	19	2E2
3,800	1,600	3	E2	202	1.9	1,000	-	-	65	17	3E2
4,200	1,600	3	E5	203	2.4	625	625	-	79	10	3E5
4,800	1,600	3	E5	203	2.8	750	750	-	86	16	3E5
5,200	1,600	3	E5	203	2.8	750	750	-	79	15	3E5

LAYOUTS DOUBLE JACKETS FS-MO, AS-MO, MS-MO

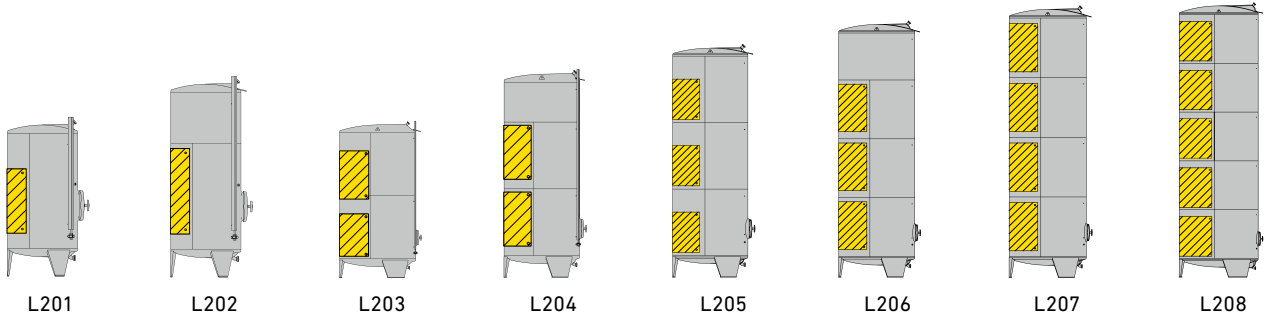

DOUBLE JACKETS FS-MO, AS-MO Ø 1.600–1.800 MM, MS-MO 1.600–1.800 MM

Capacity liter	Tank-Ø mm	Version	Connection position	Layout	Surface m ²	hd1 mm	hd2 mm	hd3 mm	Ho %	Hu %	Order No. mounted
5,800	1,600	3	E5	203	3.8	1,000	1,000	-	89	15	3E5
6,200	1,600	3	E5	203	3.8	1,000	1,000	-	82	8	3E5
6,700	1,600	2	E5	204	3.8	1,000	1,000	-	73	7	2E5
7,200	1,600	2	E5	204	3.8	1,000	1,000	-	75	10	2E5
7,700	1,600	2	E9	205	4.2	750	750	750	85	16	2E9
8,200	1,600	2	E9	205	4.2	750	750	750	86	6	2E9
8,700	1,600	2	E9	205	5.2	1,000	1,000	750	87	5	2E9
9,200	1,600	2	E9	205	5.7	1,000	1,000	1,000	87	5	2E9
9,700	1,600	4	E9	206	5.7	1,000	1,000	1,000	81	5	4E9
10,000	1,600	4	E9	206	5.7	1,000	1,000	1,000	86	12	4E9
2,400	1,800	2	E2	201	1.4	625	-	-	78	22	2E2
3,000	1,800	2	E2	201	1.7	750	-	-	76	21	2E2
3,600	1,800	2	E2	201	2.2	1,000	-	-	77	15	2E2
4,200	1,800	3	E2	201	2.2	1,000	-	-	72	19	3E2
4,800	1,800	3	E5	203	2.8	625	625	-	89	12	3E5
5,500	1,800	3	E5	203	2.8	625	625	-	79	10	3E5
6,100	1,800	3	E5	203	3.4	750	750	-	86	17	3E5
6,700	1,800	3	E5	203	4.4	1,000	1,000	-	87	9	3E5
7,300	1,800	3	E5	203	4.4	1,000	1,000	-	88	8	3E5
8,000	1,800	3	E5	203	4.4	1,000	1,000	-	82	7	3E5

CONNECTION POSITIONS DOUBLE JACKETS FS-MO, AS-MO, MS-MO

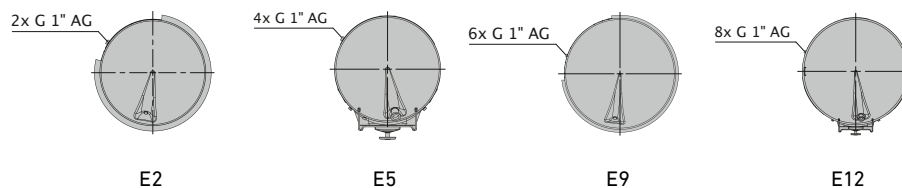

DOUBLE JACKETS FS-MO, AS-MO Ø 1.800–2.000 MM, MS-MO 1.800–2.000 MM

Capacity liter	Tank- \varnothing mm	Version	Stutzenpos.	Layout	Surface m ²	hd1 mm	hd2 mm	hd3 mm	hd4 mm	hd5 mm	Ho %	Hu %	Order No. mounted
8,500	1,800	2	E5	204	4.4	1,000	1,000	-	-	-	73	10	2E5
9,200	1,800	2	E9	205	5.1	750	750	750	-	-	91	6	2E9
9,800	1,800	2	E9	205	5.1	750	750	750	-	-	85	6	2E9
10,400	1,800	2	E9	205	5.6	1,000	750	750	-	-	86	6	2E9
11,000	1,800	2	E9	205	6.1	1,000	1,000	750	-	-	87	5	2E9
11,600	1,800	2	E9	205	6.6	1,000	1,000	1,000	-	-	87	5	2E9
12,200	1,800	2	E9	206	6.6	1,000	1,000	1,000	-	-	81	12	2E9
12,800	1,800	2	E9	206	6.6	1,000	1,000	1,000	-	-	86	12	2E9
13,500	1,800	2	E12	207	8.8	1,000	1,000	1,000	1,000	-	93	4	2E12
14,000	1,800	2	E12	207	8.8	1,000	1,000	1,000	1,000	-	94	4	2E12
14,700	1,800	2	E12	207	8.8	1,000	1,000	1,000	1,000	-	98	4	2E12
15,300	1,800	2	E12	207	8.8	1,000	1,000	1,000	1,000	-	90	4	2E12
3,000	2,000	2	E2	201	1.6	625	-	-	-	-	77	24	2E2
3,800	2,000	2	E2	201	1.9	750	-	-	-	-	75	22	2E2
4,600	2,000	2	E2	201	2.5	1,000	-	-	-	-	76	16	2E2
5,300	2,000	2	E2	201	2.5	1,000	-	-	-	-	72	20	2E2
6,100	2,000	3	E5	203	3.2	625	625	-	-	-	88	13	3E5
6,800	2,000	3	E5	203	3.8	750	750	-	-	-	84	11	3E5
7,600	2,000	3	E5	203	3.8	750	750	-	-	-	85	12	3E5
8,400	2,000	3	E5	203	5.0	1,000	1,000	-	-	-	86	9	3E5
9,200	2,000	3	E5	203	5.0	1,000	1,000	-	-	-	88	9	3E5
10,000	2,000	3	E5	203	5.0	1,000	1,000	-	-	-	81	8	3E5
10,600	2,000	2	E9	205	5.7	750	750	750	-	-	89	8	2E9
11,400	2,000	2	E9	205	5.7	750	750	750	-	-	90	7	2E9
12,200	2,000	2	E9	205	6.3	1,000	750	750	-	-	84	7	2E9
13,000	2,000	2	E9	205	6.3	1,000	750	750	-	-	85	6	2E9
13,700	2,000	2	E9	205	6.9	1,000	1,000	750	-	-	86	6	2E9
14,500	2,000	2	E9	205	7.5	1,000	1,000	1,000	-	-	87	6	2E9
15,200	2,000	2	E9	206	7.5	1,000	1,000	1,000	-	-	80	13	2E9
16,000	2,000	2	E12	206	10.0	1,000	1,000	1,000	1,000	-	93	5	2E12
16,800	2,000	2	E12	207	10.0	1,000	1,000	1,000	1,000	-	93	5	2E12
17,500	2,000	2	E12	207	10.0	1,000	1,000	1,000	1,000	-	93	5	2E12
18,300	2,000	2	E12	207	10.0	1,000	1,000	1,000	1,000	-	94	4	2E12
19,000	2,000	2	E12	207	10.0	1,000	1,000	1,000	1,000	-	90	4	2E12
20,000	2,000	3	E14	208	12.5	1,000	1,000	1,000	1,000	1,000	94	4	3E14

LAYOUTS DOUBLE JACKET FS-MO, FD-MBT

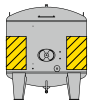

L30

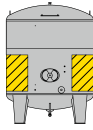

L31

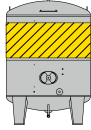

L32

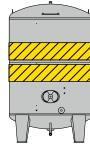

L33

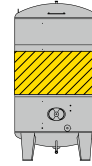

L34

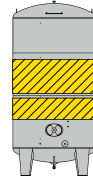

L35

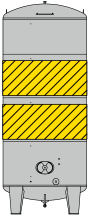

L37

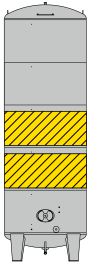

L38

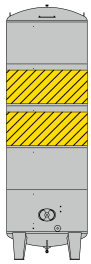

L39

DOUBLE JACKET FS-MO Ø 2,200 MM

Capacity	Tank-ø	Version	Connection position	Layout	Surface	hd1	hd2	Ho	Hu	Order No.
liter	mm				m ²	mm	mm	%	%	mounted
7,400	2,200	1	A3 : A4	L30	5.5 / 5.0	1,000	-	66	16	1A3 : 1A4
8,400	2,200	1	A3 : A4	L31	5.5 / 5.0	1,000	-	58	14	1A3 : 1A4
9,200	2,200	1	A3 : A4	L31	5.5 / 5.0	1,000	-	53	13	1A3 : 1A4
9,200	2,200	2	B5 : B6	L32	5.0	750	-	83	53	2B5 : 2B6
10,200	2,200	1	A3 : A4	L31	5.5 / 5.0	1,000	-	52	16	1A3 : 1A4
10,200	2,200	2	B5 : B6	L32	6.7	1,000	-	84	48	2B5 : 2B6
11,000	2,200	1	A3 : A4	L31	6.8 / 6.2	1,250	-	52	11	1A3 : 1A4
11,000	2,200	2	B5 : B6	L32	6.7	1,000	-	77	44	2B5 : 2B6
12,000	2,200	1	A3 : A4	L31	6.8 / 6.2	1,250	-	48	10	1A3 : 1A4
12,000	2,200	2	B5 : B6	L32	6.7	1,000	-	79	48	2B5 : 2B6
13,000	2,200	1	B7 : B8	L33	8.4	625	625	70	30	1B7 : 1B8
14,000	2,200	1	B5 : B6	L34	8.4	1,250	-	68	35	1B5 : 1B6
15,000	2,200	1	B5 : B6	L34	8.4	1,250	-	64	33	1B5 : 1B6
16,000	2,200	1	B7 : B8	L35	10.0	500	1,000	66	28	1B7 : 1B8
16,800	2,200	1	B7 : B8	L35	10.0	500	1,000	63	26	1B7 : 1B8
17,500	2,200	1	B7 : B8	L35	11.7	500	1,250	65	25	1B7 : 1B8
18,500	2,200	1	B7 : B8	L35	11.7	500	1,250	61	24	1B7 : 1B8
19,500	2,200	1	B7 : B8	L37	11.7	1,000	750	68	30	1B7 : 1B8
20,500	2,200	1	B7 : B8	L37	11.7	1,000	750	65	28	1B7 : 1B8
21,500	2,200	1	B7 : B8	L37	11.7	1,000	750	66	32	1B7 : 1B8
22,500	2,200	1	B7 : B8	L37	13.4	1,000	1,000	72	34	1B7 : 1B8
23,500	2,200	1	B7 : B8	L37	13.4	1,000	1,000	69	33	1B7 : 1B8
24,500	2,200	1	B7 : B8	L37	13.4	1,000	1,000	66	32	1B7 : 1B8
25,000	2,200	1	B7 : B8	L38	13.4	1,000	1,000	57	23	1B7 : 1B8
25,000	2,200	2	B7 : B8	L39	13.4	1,000	1,000	75	42	2B7 : 2B8

CONNECTION POSITIONS DOUBLE JACKET FS-MO, FD-MBT

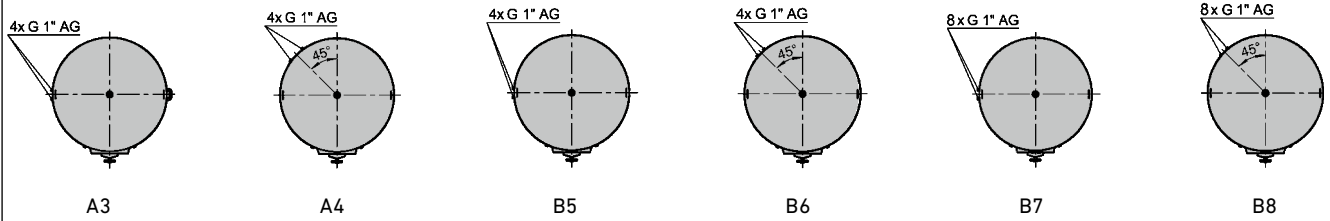

DOUBLE JACKET FS-MO, FD-MBT Ø 2,400 MM

Capacity liter	Tank- \varnothing mm	Version	Connection position	Layout	Surface m ²	hd1 mm	hd2 mm	Ho %	Hu %	Order No. mounted
8,900	2,400	1	A3 : A4	L30	6.1/5.5	1,000	-	65	17	1A3 : 1A4
10,000	2,400	1	A3 : A4	L31	6.1/5.5	1,000	-	58	15	1A3 : 1A4
11,200	2,400	1	A3 : A4	L31	6.1/5.5	1,000	-	53	13	1A3 : 1A4
12,300	2,400	1	A3 : A4	L31	6.1/5.5	1,000	-	52	16	1A3 : 1A4
12,300	2,400	2	B5 : B6	L32	7.4	1,000	-	90	48	2B5 : 2B6
13,500	2,400	1	A3 : A4	L31	7.6/6.8	1,250	-	52	11	1A3 : 1A4
13,500	2,400	2	B5 : B6	L32	7.4	1,000	-	77	44	2B5 : 2B6
14,500	2,400	1	A3 : A4	L31	7.6/6.8	1,250	-	48	10	1A3 : 1A4
14,500	2,400	2	B5 : B6	L32	7.4	1,000	-	71	48	2B5 : 2B6
15,500	2,400	1	B7 : B8	L33	9.2	625	625	70	31	1B7 : 1B8
16,500	2,400	1	B5 : B6	L34	9.2	1,250	-	68	35	1B5 : 1B6
18,000	2,400	1	B5 : B6	L34	9.2	1,250	-	64	33	1B5 : 1B6
19,000	2,400	1	B7 : B8	L35	12.0	625	1,000	66	25	1B7 : 1B8
20,000	2,400	1	B7 : B8	L35	12.9	500	1,250	68	27	1B7 : 1B8
21,000	2,400	1	B7 : B8	L35	12.9	500	1,250	64	25	1B7 : 1B8
22,500	2,400	1	B7 : B8	L35	12.9	500	1,250	60	24	1B7 : 1B8
23,500	2,400	1	B7 : B8	L37	14.7	1,000	1,000	72	30	1B7 : 1B8
24,500	2,400	1	B7 : B8	L37	14.7	1,000	1,000	69	29	1B7 : 1B8
25,500	2,400	1	B7 : B8	L37	14.7	1,000	1,000	71	32	1B7 : 1B8
27,000	2,400	1	B7 : B8	L37	14.7	1,000	1,000	72	35	1B7 : 1B8
28,000	2,400	1	B7 : B8	L37	14.7	1,000	1,000	69	33	1B7 : 1B8
29,000	2,400	1	B7 : B8	L37	14.7	1,000	1,000	66	32	1B7 : 1B8
30,000	2,400	1	B7 : B8	L38	14.7	1,000	1,000	56	23	1B7 : 1B8
30,000	2,400	2	B7 : B8	L39	14.7	1,000	1,000	76	42	2B7 : 2B8

LAYOUTS DOUBLE JACKET FS-MO, FD-MBT

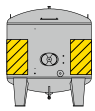

L30

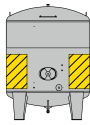

L31

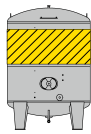

L32

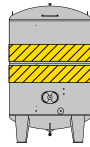

L33

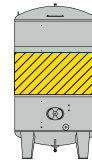

L34

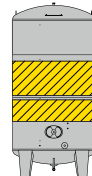

L35

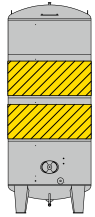

L37



L40

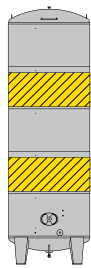

L42

DOUBLE JACKET FS-MO Ø 2,600 MM

Capacity	Tank-ø	Version	Connection position	Layout	Surface	hd1	hd2	hd3	Ho	Hu	Order No.
liter	mm				m ²	mm	mm	mm	%	%	mounted
10,800	2,600	1	A3 : A4	L30	6.7 / 5.9	1,000	-	-	65	17	1A3 : 1A4
12,200	2,600	1	A3 : A4	L31	6.7 / 5.9	1,000	-	-	58	16	1A3 : 1A4
13,500	2,600	1	A3 : A4	L31	8.4 / 7.4	1,250	-	-	62	14	1A3 : 1A4
14,500	2,600	1	A3 : A4	L31	8.4 / 7.4	1,250	-	-	57	13	1A3 : 1A4
14,500	2,600	2	B5 : B6	L32	8.0	1,000	-	-	83	48	2B5 : 2B6
16,000	2,600	1	A3 : A4	L31	8.4 / 7.4	1,250	-	-	52	12	1A3 : 1A4
16,000	2,600	2	B5 : B6	L32	10.0	1,250	-	-	84	44	2B5 : 2B6
17,300	2,600	1	B7 : B8	L33	10.0	625	625	-	74	33	1B7 : 1B8
18,500	2,600	1	B7 : B8	L33	11.0	625	750	-	73	31	1B7 : 1B8
20,000	2,600	1	B7 : B8	L35	11.0	625	750	-	68	29	1B7 : 1B8
21,300	2,600	1	B7 : B8	L35	12.0	500	1,000	-	70	30	1B7 : 1B8
22,500	2,600	1	B7 : B8	L35	12.0	500	1,000	-	66	28	1B7 : 1B8
24,000	2,600	1	B7 : B8	L35	14.0	500	1,250	-	68	27	1B7 : 1B8
25,300	2,600	1	B7 : B8	L35	14.0	500	1,250	-	64	25	1B7 : 1B8
26,500	2,600	1	B7 : B8	L35	14.0	500	1,250	-	61	24	1B7 : 1B8
28,000	2,600	1	B7 : B8	L37	15.9	1,000	1,000	-	72	30	1B7 : 1B8
29,000	2,600	1	B7 : B8	L37	15.9	1,000	1,000	-	69	29	1B7 : 1B8
30,500	2,600	1	B7 : B8	L37	15.9	1,000	1,000	-	70	32	1B7 : 1B8
32,000	2,600	1	B7 : B8	L37	17.9	1,250	1,000	-	72	31	1B7 : 1B8
33,000	2,600	1	B7 : B8	L37	19.9	1,250	1,250	-	72	29	1B7 : 1B8
34,500	2,600	1	B7 : B8	L37	19.9	1,250	1,250	-	70	28	1B7 : 1B8
35,800	2,600	1	B7 : B8	L42	19.9	1,250	1,250	-	78	23	1B7 : 1B8
37,000	2,600	1	B7 : B8	L42	19.9	1,250	1,250	-	79	23	1B7 : 1B8
38,500	2,600	1	B9 : B10	L40	23.9	1,000	1,000	1,000	77	22	1B9 : 1B10
39,800	2,600	1	B9 : B10	L40	23.9	1,000	1,000	1,000	74	21	1B9 : 1B10

CONNECTION POSITIONS DOUBLE JACKET FS-MO, FD-MBT

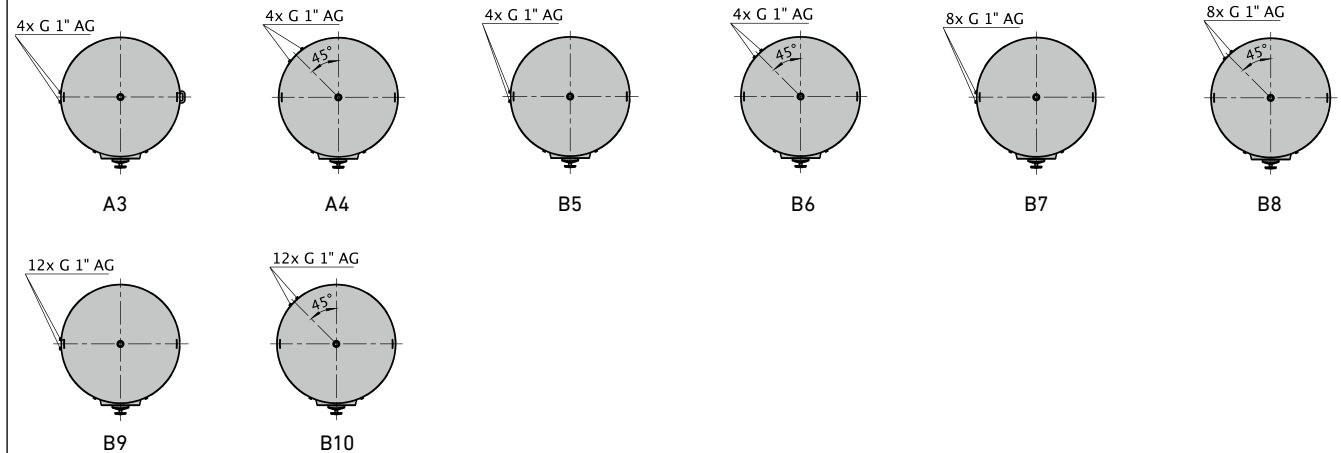

DOUBLE JACKET FS-MO, FD-MBT Ø 2,800 MM

Capacity	Tank-ø	Version	Connection position	Layout Surface	hd1	hd2	hd3	Ho	Hu	Order No.
liter	mm			m ²	mm	mm	mm	%	%	mounted
12,500	2,800	1	A3 : A4	L30	7.2 / 6.4	1,000	-	65	18	1A3 : 1A4
14,000	2,800	1	A3 : A4	L31	7.2 / 6.4	1,000	-	58	16	1A3 : 1A4
15,500	2,800	1	A3 : A4	L31	9.0 / 8.0	1,250	-	62	14	1A3 : 1A4
17,000	2,800	1	A3 : A4	L31	9.0 / 8.0	1,250	-	57	13	1A3 : 1A4
17,000	2,800	2	B5 : B6	L32	8.6	1,000	-	83	48	2B5 : 2B6
18,500	2,800	1	A3 : A4	L31	9.0 / 8.0	1,250	-	52	12	1A3 : 1A4
18,500	2,800	2	B5 : B6	L32	10.8	1,250	-	84	44	2B5 : 2B6
20,000	2,800	1	B5 : B6	L32	10.8	1,250	-	86	48	1B5 : 1B6
20,000	2,800	2	B7 : B8	L33	11.9	625	750	77	33	2B7 : 2B8
21,500	2,800	1	B7 : B8	L33	11.9	625	750	72	31	1B7 : 1B8
23,000	2,800	1	B7 : B8	L35	11.9	625	750	68	29	1B7 : 1B8
24,500	2,800	1	B7 : B8	L35	14.0	625	1,000	70	27	1B7 : 1B8
26,000	2,800	1	B7 : B8	L35	14.0	625	1,000	66	26	1B7 : 1B8
27,500	2,800	1	B7 : B8	L35	15.1	500	1,250	68	27	1B7 : 1B8
29,400	2,800	1	B7 : B8	L35	15.1	500	1,250	64	26	1B7 : 1B8
31,000	2,800	1	B7 : B8	L35	16.2	625	1,250	61	22	1B7 : 1B8
32,500	2,800	1	B7 : B8	L37	17.3	1,000	1,000	72	30	1B7 : 1B8
34,000	2,800	1	B7 : B8	L37	21.6	1,250	1,250	74	24	1B7 : 1B8
35,500	2,800	1	B7 : B8	L37	21.6	1,250	1,250	71	23	1B7 : 1B8
37,000	2,800	1	B7 : B8	L37	21.6	1,250	1,250	76	30	1B7 : 1B8
38,500	2,800	1	B7 : B8	L37	21.6	1,250	1,250	73	29	1B7 : 1B8
40,000	2,800	1	B7 : B8	L37	21.6	1,250	1,250	70	28	1B7 : 1B8
41,500	2,800	1	B9 : B10	L40	25.8	1,000	1,000	75	23	1B9 : 1B10
43,000	2,800	1	B9 : B10	L40	25.8	1,000	1,000	76	26	1B9 : 1B10
44,500	2,800	1	B9 : B10	L40	25.8	1,000	1,000	69	25	1B9 : 1B10

LAYOUTS DOUBLE JACKET FS-MO



L30

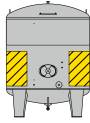

L31

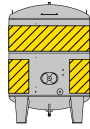

L43

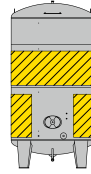

L44

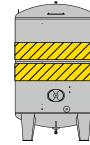

L33



L35

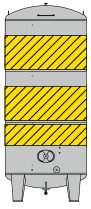

L45

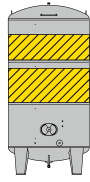

L36

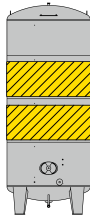

L37



L40

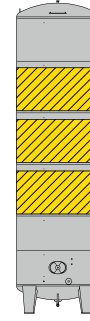

L46

DOUBLE JACKET FS-MO Ø 3,000 MM

Capacity	Tank-ø	Version	Connection position	Layout	Surface	hd1	hd2	hd3	Ho	Hu	Order No.
liter	mm				m ²	mm	mm	mm	%	%	mounted
16,000	3,000	1	A3 : A4	L30	9.9/8.6	1,250	-	-	75	20	1A3 : 1A4
17,500	3,000	1	A3 : A4	L31	7.9/6.9	1,000	-	-	62	23	1A3 : 1A4
19,500	3,000	1	A3 : A4	L31	9.9/8.6	1,250	-	-	61	17	1A3 : 1A4
21,000	3,000	1	B7 : B8	L33	10.4	625	500	-	80	40	1B7 : 1B8
23,000	3,000	1	B7 : B8	L33	12.7	625	750	-	82	37	1B7 : 1B8
24,500	3,000	1	B7 : B8	L33	12.7	625	750	-	76	34	1B7 : 1B8
26,500	3,000	1	B7 : B8	L33	15.0	625	1,000	-	78	32	1B7 : 1B8
28,000	3,000	1	B7 : B8	L35	15.0	625	1,000	-	73	30	1B7 : 1B8
30,000	3,000	1	B7 : B8	L35	17.3	625	1,250	-	75	28	1B7 : 1B8
31,500	3,000	1	B7 : B8	L35	17.3	625	1,250	-	71	27	1B7 : 1B8
33,500	3,000	1	B7 : B8	L35	17.3	625	1,250	-	67	25	1B7 : 1B8
35,000	3,000	1	B7 : B8	L35	17.3	625	1,250	-	64	24	1B7 : 1B8
35,000	3,000	2	B7 : B8	L36	20.8	1,250	1,000	-	83	34	2B7 : 2B8
37,000	3,000	1	B7 : B8	L36	20.8	1,250	1,000	-	84	37	1B7 : 1B8
38,500	3,000	1	B7 : B8	L37	23.1	1,250	1,250	-	76	27	1B7 : 1B8
40,500	3,000	1	B7 : B8	L37	23.1	1,250	1,250	-	73	25	1B7 : 1B8
42,000	3,000	1	B7 : B8	L37	23.1	1,250	1,250	-	69	24	1B7 : 1B8
44,000	3,000	1	B7 : B8	L37	23.1	1,250	1,250	-	75	31	1B7 : 1B8
45,500	3,000	1	B7 : B8	L37	23.1	1,250	1,250	-	72	30	1B7 : 1B8
47,500	3,000	1	B7 : B8	L37	23.1	1,250	1,250	-	69	29	1B7 : 1B8
49,000	3,000	1	B9 : B10	L40	27.7	1,000	1,000	1,000	74	25	1B9 : 1B10
51,000	3,000	1	B9 : B10	L40	27.7	1,000	1,000	1,000	75	27	1B9 : 1B10
53,000	3,000	1	B9 : B10	L40	27.7	1,000	1,000	1,000	72	26	1B9 : 1B10
54,500	3,000	1	B9 : B10	L40	34.5	1,250	1,250	1,250	77	22	1B9 : 1B10
56,500	3,000	1	B9 : B10	L40	34.5	1,250	1,250	1,250	77	24	1B9 : 1B10
58,000	3,000	1	B9 : B10	L40	34.5	1,250	1,250	1,250	75	24	1B9 : 1B10

CONNECTION POSITIONS DOUBLE JACKET FS-MO

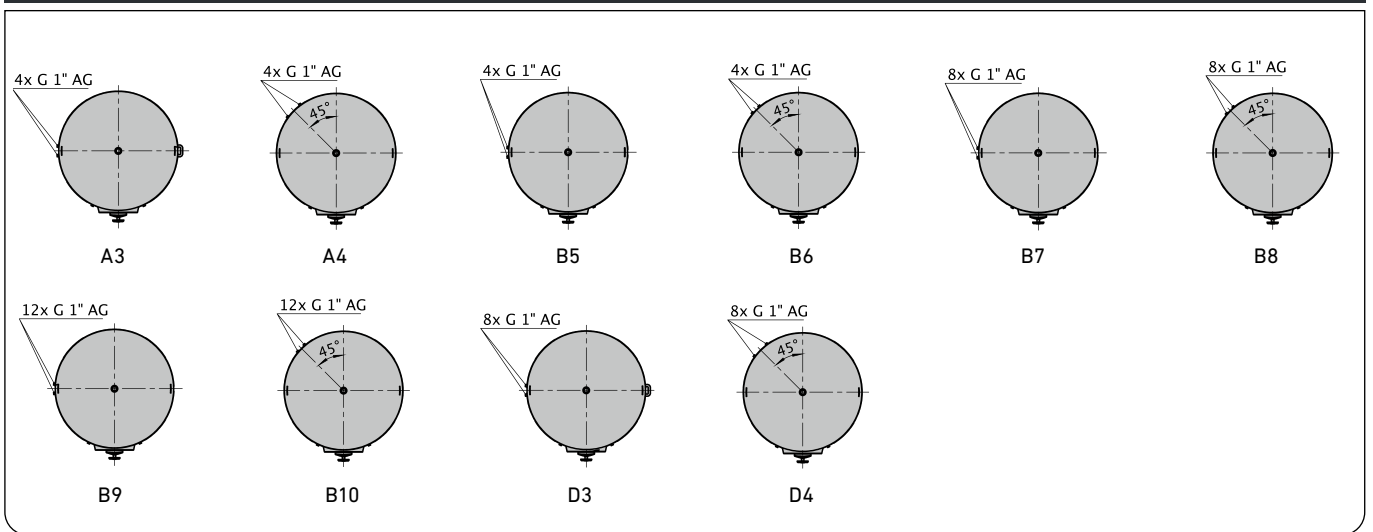

DOUBLE JACKET FS-MO Ø 3,200 MM

Capacity	Tank-ø	Version	Connection position	Layout Surface	hd1	hd2	hd3	Ho	Hu	Order No.
liter	mm			m ²	mm	mm	mm	%	%	mounted
18,800	3,200	1	A3 : A4	L30 10.5/09.1	1,250	-	-	74	21	1A3 : 1A4
20,500	3,200	1	D3 : D4*	L43 12.4/11.5	750	625	-	81	19	1D3 : 1D4
22,500	3,200	1	D3 : D4*	L43 13.7/12.8	750	750	-	78	17	1D3 : 1D4
24,500	3,200	1	D3 : D4*	L43 15.8/14.6	1,000	750	-	80	16	1D3 : 1D4
26,500	3,200	1	D3 : D4*	L43 15.8/14.6	1000	750	-	74	15	1D3 : 1D4
26,500	3,200	2	B7 : B8	L33 13.4	625	750	-	82	37	2B7 : 2B8
28,500	3,200	1	D3 : D4*	L43 17.9/16.4	1,250	750	-	76	14	1D3 : 1D4
28,500	3,200	2	B7 : B8	L33 15.9	625	1,000	-	83	34	2B7 : 2B8
30,500	3,200	1	D3 : D4*	L43 20.3/18.9	1,250	1,000	-	77	13	1D3 : 1D4
30,500	3,200	2	B7 : B8	L33 18.3	625	1,250	-	84	32	2B7 : 2B8
32,500	3,200	1	D3 : D4*	L44 20.7/19.5	1,000	1,250	-	73	12	1D3 : 1D4
32,500	3,200	2	B7 : B8	L36 18.3	1,250	625	-	88	36	2B7 : 2B8
34,500	3,200	1	D3 : D4*	L44 20.3/18.9	1,250	1,000	-	69	11	1D3 : 1D4
34,500	3,200	2	B7 : B8	L36 19.6	1,000	1,000	-	86	34	2B7 : 2B8
36,500	3,200	1	B7 : B8	L36 22.0	1,250	1,000	-	86	32	1B7 : 1B8
38,500	3,200	1	B7 : B8	L36 22.0	1,250	1,000	-	82	31	1B7 : 1B8
40,500	3,200	1	B7 : B8	L36 24.5	1,250	1,250	-	88	34	1B7 : 1B8
42,500	3,200	1	B9 : B10	L45 25.7	625	1,000	1,000	84	23	1B9 : 1B10
44,500	3,200	1	B9 : B10	L41 29.4	1,000	1,000	1,000	89	27	1B9 : 1B10
46,500	3,200	1	B9 : B10	L41 29.4	1,000	1,000	1,000	89	30	1B9 : 1B10
48,500	3,200	1	B9 : B10	L41 29.4	1,000	1,000	1,000	90	24	1B9 : 1B10
50,500	3,200	1	B9 : B10	L41 29.4	1,000	1,000	1,000	86	23	1B9 : 1B10
52,500	3,200	1	B9 : B10	L41 29.4	1,000	1,000	1,000	87	26	1B9 : 1B10
54,500	3,200	1	B9 : B10	L41 31.8	1,250	1,000	1,000	87	29	1B9 : 1B10
56,500	3,200	1	B9 : B10	L40 31.8	1,250	1,000	1,000	77	25	1B9 : 1B10
58,500	3,200	1	B9 : B10	L40 34.3	1,250	1,250	1,000	78	24	1B9 : 1B10
60,500	3,200	1	B9 : B10	L40 36.7	1,250	1,250	1,250	79	23	1B9 : 1B10
62,500	3,200	1	B9 : B10	L40 36.7	1,250	1,250	1,250	76	22	1B9 : 1B10
64,000	3,200	1	B9 : B10	L40 36.7	1,250	1,250	1,250	77	25	1B9 : 1B10
66,500	3,200	1	B9 : B10	L40 36.7	1,250	1,250	1,250	75	24	1B9 : 1B10
68,500	3,200	1	B9 : B10	L46 36.7	1,250	1,250	1,250	78	29	1B9 : 1B10

D3 = combination A3 / B5, D4 = combination A4 / B6

LAYOUTS DOUBLE JACKET FS-MO



DOUBLE JACKET FS-MO Ø 3,400 MM

Capacity liter	Tank- ϕ mm	Version	Connection position	Layout	Surface m ²	hd1 mm	hd2 mm	hd3 mm	Ho %	Hu %	Order No. mounted
21,500	3,400	1	A3 : A4	L30	11.3/9.7	1,250	-	-	73	22	1A3 : 1A4
24,000	3,400	1	D3 : D4*	L43	13.3/12.3	750	625	-	80	20	1D3 : 1D4*
26,000	3,400	1	D3 : D4*	L43	14.6/13.6	750	750	-	78	18	1D3 : 1D4*
28,000	3,400	1	D3 : D4*	L43	16.9/15.5	1,000	750	-	80	16	1D3 : 1D4*
30,500	3,400	1	D3 : D4*	L43	19.5/18.1	1,000	1,000	-	81	15	1D3 : 1D4*
30,500	3,400	2	B7 : B8	L33	14.3	625	750	-	81	37	2B7 : 2B8
33,000	3,400	1	D3 : D4*	L43	21.7/20.1	1,250	1,000	-	82	14	1D3 : 1D4*
33,000	3,400	2	B7 : B8	L33	16.9	625	1,000	-	82	35	2B7 : 2B8
35,000	3,400	1	D3 : D4*	L43	21.7/20.1	1,250	1,000	-	77	13	1D3 : 1D4*
35,000	3,400	2	B7 : B8	L33	19.5	625	1,250	-	83	32	2B7 : 2B8
37,500	3,400	1	D3 : D4*	L44	22.1/20.7	1,000	1,250	-	72	13	1D3 : 1D4*
37,500	3,400	2	B7 : B8	L36	19.5	1,250	625	-	87	36	2B7 : 2B8
39,500	3,400	1	D3 : D4*	L44	24.3/22.7	1,250	1,250	-	74	12	1D3 : 1D4*
39,500	3,400	2	B7 : B8	L36	20.8	1,000	1,000	-	85	34	2B7 : 2B8
42,000	3,400	1	B7 : B8	L36	23.4	1,250	1,000	-	86	33	1B7 : 1B8
44,000	3,400	1	B7 : B8	L36	26.0	1,250	1,250	-	87	31	1B7 : 1B8
46,500	3,400	1	B7 : B8	L36	26.0	1,250	1,250	-	87	34	1B7 : 1B8
48,500	3,400	1	B9 : B10	L45	27.3	625	1,000	1,000	83	23	1B9 : 1B10
51,000	3,400	1	B9 : B10	L41	31.2	1,000	1,000	1,000	89	27	1B9 : 1B10
53,000	3,400	1	B9 : B10	L41	31.2	1,000	1,000	1,000	89	30	1B9 : 1B10
55,500	3,400	1	B9 : B10	L41	31.2	1,000	1,000	1,000	89	25	1B9 : 1B10
57,500	3,400	1	B9 : B10	L41	31.2	1,000	1,000	1,000	86	24	1B9 : 1B10

D3 = combination A3/B5, D4 = combination A4/B6

CONNECTION POSITIONS DOUBLE JACKET FS-MO

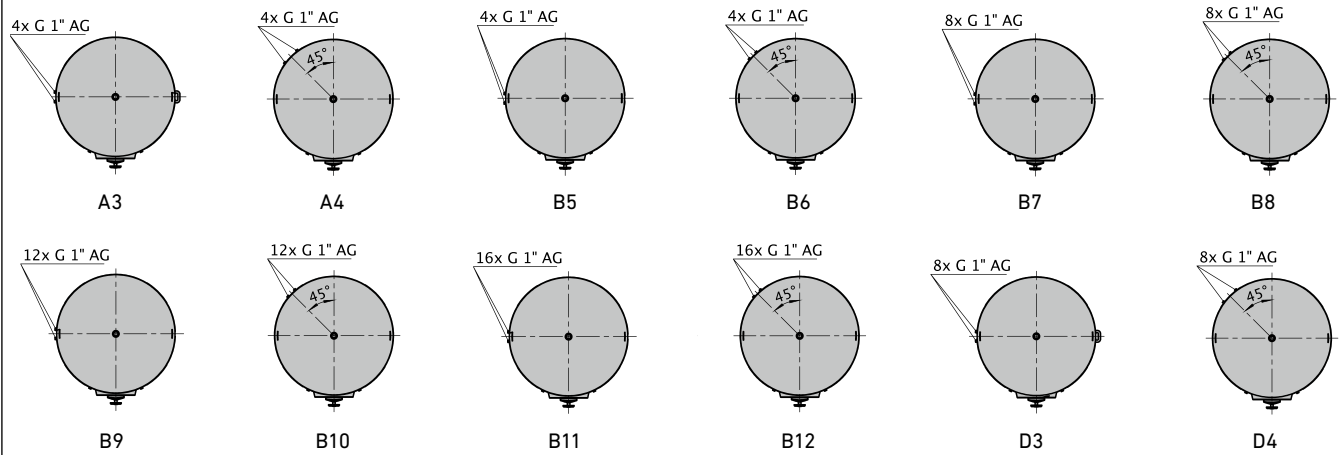

DOUBLE JACKET FS-MO Ø 3,400 MM

Capacity	Tank-ø	Version	Connection position	Layout	Surface	hd1	hd2	hd3	hd4	Ho	Hu	Order No.
liter	mm				m ²	mm	mm	mm	mm	%	%	mounted
60,000	3,400	1	B9 : B10	L41	33.8	1,250	1,000	1,000	-	87	27	1B9 : 1B10
62,000	3,400	1	B9 : B10	L41	33.8	1,250	1,000	1,000	-	87	29	1B9 : 1B10
64,500	3,400	1	B9 : B10	L40	39.0	1,250	1,250	1,250	-	80	21	1B9 : 1B10
66,500	3,400	1	B9 : B10	L40	39.0	1,250	1,250	1,250	-	78	20	1B9 : 1B10
69,000	3,400	1	B9 : B10	L40	39.0	1,250	1,250	1,250	-	78	23	1B9 : 1B10
71,000	3,400	1	B9 : B10	L40	39.0	1,250	1,250	1,250	-	76	22	1B9 : 1B10
73,000	3,400	1	B11 : B12	L47	41.6	1,000	1,000	1,000	1,000	89	22	1B11 : 1B12
73,000	3,400	2	B9 : B10	L40	39.0	1,250	1,250	1,250	-	77	25	2B9 : 2B10
75,500	3,400	1	B11 : B12	L47	41.6	1,000	1,000	1,000	1,000	89	24	1B11 : 1B12
75,500	3,400	2	B9 : B10	L40	39.0	1,250	1,250	1,250	-	74	24	2B9 : 2B10
78,000	3,400	1	B11 : B12	L48	41.6	1,000	1,000	1,000	1,000	81	18	1B11 : 1B12
80,000	3,400	1	B11 : B12	L48	46.8	1,250	1,000	1,250	1,000	79	17	1B11 : 1B12
82,000	3,400	1	B11 : B12	L48	49.4	1,250	1,250	1,250	1,000	79	19	1B11 : 1B12
84,500	3,400	1	B11 : B12	L48	49.4	1,250	1,250	1,250	1,000	80	21	1B11 : 1B12
87,000	3,400	1	B11 : B12	L48	49.4	1,250	1,250	1,250	1,000	78	21	1B11 : 1B12
89,000	3,400	1	B11 : B12	L48	52.0	1,250	1,250	1,250	1,250	78	20	1B11 : 1B12

LAYOUTS DOUBLE JACKET FS-MO

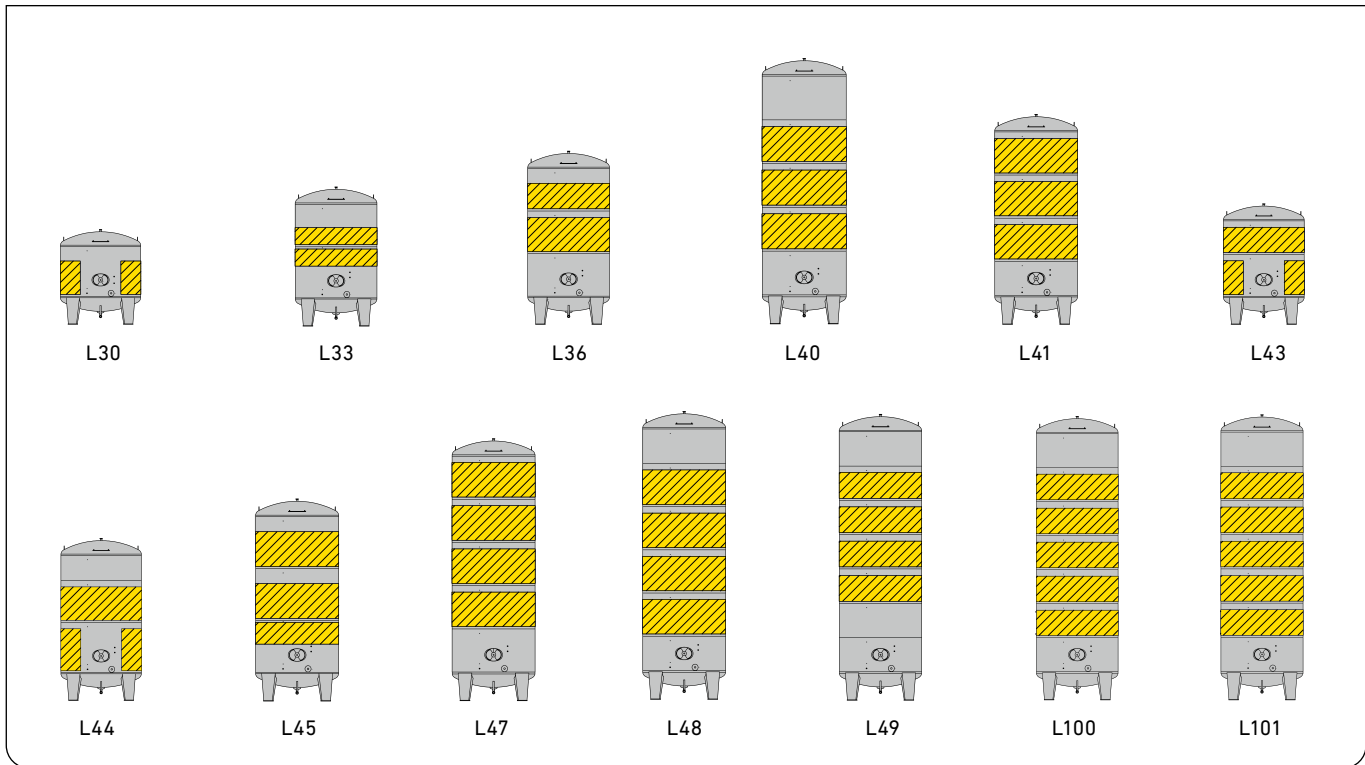

DOUBLE JACKET FS-MO Ø 3,600 MM

Capacity	Tank-ø	Version	Connection position	Layout	Surface	hd1	hd2	hd3	hd4	hd5	Ho	Hu	Order No.
liter	mm				m ²	mm	mm	mm	mm	mm	%	%	mounted
24,500	3,600	1	A3 : A4	L30	12.1 / 10.2	1,250	-	-	-	-	73	22	1A3 : 1A4
27,000	3,600	1	D3 : D4 *	L43	14.2 / 13.0	750	625	-	-	-	80	20	1D3 : 1D4
29,500	3,600	1	D3 : D4 *	L43	15.5 / 14.4	750	750	-	-	-	77	18	1D3 : 1D4
32,000	3,600	1	D3 : D4 *	L43	18.0 / 16.4	1,000	750	-	-	-	79	17	1D3 : 1D4
35,000	3,600	1	D3 : D4 *	L43	20.7 / 19.2	1,000	1,000	-	-	-	81	16	1D3 : 1D4
35,000	3,600	2	B7 : B8	L33	15.1	625	750	-	-	-	81	37	2B7 : 2B8
37,500	3,600	1	D3 : D4 *	L43	23.1 / 21.2	1,250	1,000	-	-	-	82	15	1D3 : 1D4
37,500	3,600	2	B7 : B8	L33	17.9	625	1,000	-	-	-	82	35	2B7 : 2B8
40,000	3,600	1	D3 : D4 *	L43	23.1 / 21.2	1,250	1,000	-	-	-	77	14	1D3 : 1D4
40,000	3,600	2	B7 : B8	L33	20.7	625	1,250	-	-	-	83	33	2B7 : 2B8
42,500	3,600	1	D3 : D4 *	L44	23.5 / 22.0	1,000	1,250	-	-	-	72	13	1D3 : 1D4
42,500	3,600	2	B7 : B8	L36	20.7	1,250	625	-	-	-	87	37	2B7 : 2B8
45,000	3,600	1	D3 : D4 *	L44	25.9 / 24.0	1,250	1,250	-	-	-	74	12	1D3 : 1D4
45,000	3,600	2	B7 : B8	L36	22.0	1,000	1,000	-	-	-	85	35	2B7 : 2B8
47,500	3,600	1	B7 : B8	L36	24.8	1,250	1,000	-	-	-	86	33	1B7 : 1B8
50,000	3,600	1	B7 : B8	L36	27.6	1,250	1,250	-	-	-	86	31	1B7 : 1B8
52,500	3,600	1	B7 : B8	L36	27.6	1,250	1,250	-	-	-	87	34	1B7 : 1B8
55,000	3,600	1	B9 : B10	L45	28.9	625	1,000	1,000	-	-	83	24	1B9 : 1B10
57,500	3,600	1	B9 : B10	L41	33.0	1,000	1,000	1,000	-	-	88	27	1B9 : 1B10
60,000	3,600	1	B9 : B10	L41	33.0	1,000	1,000	1,000	-	-	89	30	1B9 : 1B10
62,500	3,600	1	B9 : B10	L41	38.6	1,250	1,250	1,000	-	-	89	25	1B9 : 1B10
65,000	3,600	1	B9 : B10	L41	38.6	1,250	1,250	1,000	-	-	86	24	1B9 : 1B10
67,500	3,600	1	B9 : B10	L41	38.6	1,250	1,250	1,000	-	-	86	27	1B9 : 1B10
70,000	3,600	1	B9 : B10	L41	41.4	1,250	1,250	1,250	-	-	90	29	1B9 : 1B10
72,500	3,600	1	B9 : B10	L40	41.4	1,250	1,250	1,250	-	-	80	21	1B9 : 1B10
75,000	3,600	1	B9 : B10	L40	41.4	1,250	1,250	1,250	-	-	78	21	1B9 : 1B10
78,000	3,600	1	B9 : B10	L40	41.4	1,250	1,250	1,250	-	-	78	23	1B9 : 1B10
80,000	3,600	1	B9 : B10	L40	41.4	1,250	1,250	1,250	-	-	76	23	1B9 : 1B10
83,000	3,600	1	B11 : B12	L47	49.6	1,250	1,000	1,250	1,000	-	89	22	1B11 : 1B12
85,500	3,600	1	B11 : B12	L47	49.6	1,250	1,000	1,250	1,000	-	89	24	1B11 : 1B12
88,000	3,600	1	B11 : B12	L48	49.6	1,250	1,250	1,000	1,000	-	81	21	1B11 : 1B12

CONNECTION POSITIONS DOUBLE JACKET FS-MO

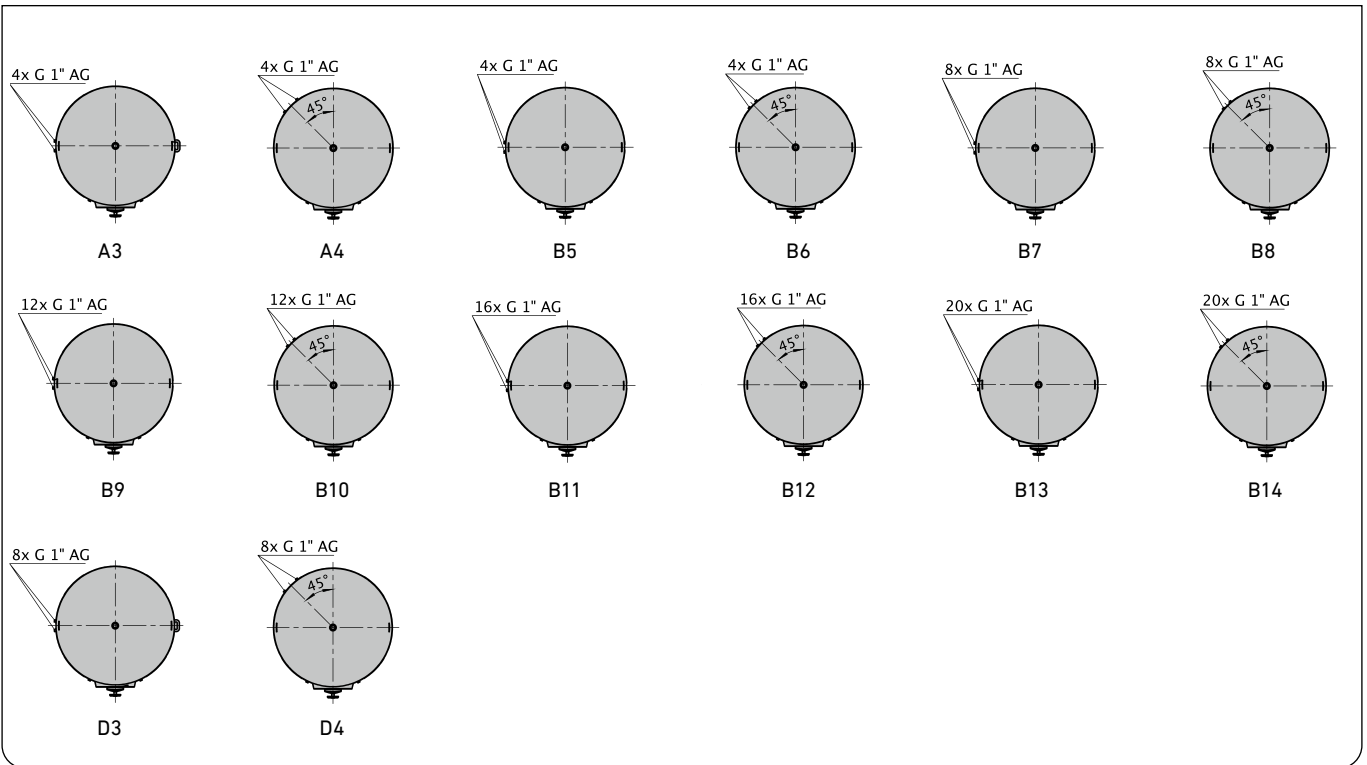

DOUBLE JACKET FS-MO Ø 3,600 MM

Capacity liter	Tank-ø mm	Version	Connection		Surface	hd1	hd2	hd3	hd4	hd5	Ho	Hu	Order No. mounted
			position	Layout									
90,000	3,600	1	B11 : B12	L48	52.4	1,250	1,250	1,250	1,000	-	81	20	1B11 : 1B12
93,000	3,600	1	B11 : B12	L48	52.4	1,250	1,250	1,250	1,000	-	79	19	1B11 : 1B12
95,500	3,600	1	B11 : B12	L48	55.2	1,250	1,250	1,250	1,250	-	80	19	1B11 : 1B12
98,000	3,600	1	B11 : B12	L48	55.2	1,250	1,250	1,250	1,250	-	80	21	1B11 : 1B12
100,500	3,600	1	B11 : B12	L48	55.2	1,250	1,250	1,250	1,250	-	78	21	1B11 : 1B12
103,000	3,600	1	B11 : B12	L49	55.2	1,250	1,250	1,250	1,250	-	81	25	1B11 : 1B12
105,500	3,600	1	B13 : B14	L100	63.4	1,000	1,250	1,250	1,250	1,000	82	17	1B13 : 1B14
108,000	3,600	1	B13 : B14	L100	63.4	1,000	1,250	1,250	1,250	1,000	82	19	1B13 : 1B14
110,500	3,600	1	B13 : B14	L100	63.4	1,000	1,250	1,250	1,250	1,000	82	21	1B13 : 1B14
113,000	3,600	1	B13 : B14	L100	63.4	1,000	1,250	1,250	1,250	1,000	81	20	1B13 : 1B14
115,500	3,600	1	B13 : B14	L100	63.4	1,000	1,250	1,250	1,250	1,000	79	20	1B13 : 1B14
118,000	3,600	1	B13 : B14	L101	63.4	1,250	1,250	1,250	1,000	1,000	84	26	1B13 : 1B14
120,500	3,600	1	B13 : B14	L101	69.0	1,250	1,250	1,250	1,250	1,250	84	23	1B13 : 1B14
123,000	3,600	1	B13 : B14	L101	69.0	1,250	1,250	1,250	1,250	1,250	84	25	1B13 : 1B14
126,000	3,600	1	B13 : B14	L101	69.0	1,250	1,250	1,250	1,250	1,250	83	24	1B13 : 1B14

LAYOUTS DOUBLE JACKET RS-MO, RA-MO, RS-MO-Q, RA-MO-Q

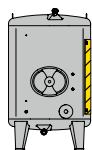

L50

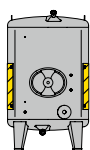

L51

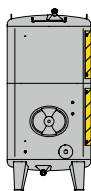

L52

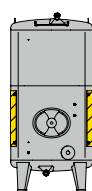

L53

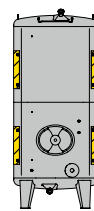

L54

DOUBLE JACKETS RS-MO, RA-MO Ø 900 X 1,400–1,300 X 1,800 MM

Capacity	Tank-Ø	Version	Connection position	Layout	Surface	hd1	hd2	Ho	Hu	Order No.
liter	mm				m ²	mm	mm	%	%	mounted
950	900x1,400	1	C1 : C5	L50	0.6	500	-	79	21	1C1 : 1C5
950	900x1,400	2	C2 : C6	L51	0.7	333	-	67	28	2C2 : 2C6
1,100	900x1,400	1	C1 : C5	L50	0.7	625	-	82	18	1C1 : 1C5
1,100	900x1,400	2	C2 : C6	L51	0.7	333	-	65	31	2C2 : 2C6
1,400	900x1,400	1	C1 : C5	L50	0.8	750	-	76	15	1C1 : 1C5
1,400	900x1,400	2	C2 : C6	L51	0.7	333	-	60	33	2C2 : 2C6
1,650	900x1,400	1	C1 : C5	L50	1.1	1,000	-	80	12	1C1 : 1C5
1,650	900x1,400	2	C2 : C6	L51	1.1	500	-	59	25	2C2 : 2C6
1,950	900x1,400	1	C1 : C5	L50	1.1	1,000	-	68	10	1C1 : 1C5
1,950	900x1,400	2	C2 : C6	L51	1.1	500	-	56	27	2C2 : 2C6
2,250	900x1,400	1	C3 : C7	L52	1.4	750	500	85	15	1C3 : 1C7
2,250	900x1,400	2	C2 : C6	L53	1.4	625	-	53	21	2C2 : 2C6
2,500	900x1,400	1	C3 : C7	L52	1.4	750	500	75	13	1C3 : 1C7
2,500	900x1,400	2	C2 : C6	L53	1.4	625	-	47	19	2C2 : 2C6
2,500	900x1,400	3	C4 : C8	L54	2.2	500	500	81	13	3C4 : 3C8
2,800	900x1,400	1	C3 : C7	L52	1.7	1,000	500	78	12	1C3 : 1C7
2,800	900x1,400	2	C2 : C6	L53	1.7	750	-	49	19	2C2 : 2C6
2,800	900x1,400	3	C4 : C8	L54	2.2	500	500	82	12	3C4 : 3C8
3,100	900x1,400	1	C3 : C7	L52	1.7	1,000	500	71	11	1C3 : 1C7
3,100	900x1,400	2	C2 : C6	L53	1.7	750	-	44	17	2C2 : 2C6
3,100	900x1,400	3	C4 : C8	L54	2.2	500	500	75	11	3C4 : 3C8
1,500	1,100x1,600	1	C1 : C5	L50	0.8	625	-	82	18	1C1 : 1C5
1,500	1,100x1,600	2	C2 : C6	L51	0.8	333	-	63	29	2C2 : 2C6
1,900	1,100x1,600	1	C1 : C5	L50	0.9	750	-	76	15	1C1 : 1C5
1,900	1,100x1,600	2	C2 : C6	L51	1.3	500	-	62	22	2C2 : 2C6
2,300	1,100x1,600	1	C1 : C5	L50	1.3	1,000	-	80	12	1C1 : 1C5
2,300	1,100x1,600	2	C2 : C6	L51	1.6	625	-	59	17	2C2 : 2C6
2,700	1,100x1,600	1	C1 : C5	L50	1.6	1,250	-	83	11	1C1 : 1C5
2,700	1,100x1,600	2	C2 : C6	L51	1.6	625	-	56	20	2C2 : 2C6
3,100	1,100x1,600	1	C3 : C7	L52	1.7	750	625	91	15	1C3 : 1C7
3,100	1,100x1,600	2	C2 : C6	L53	1.9	750	-	53	15	2C2 : 2C6
3,500	1,100x1,600	1	C3 : C7	L52	1.9	750	750	87	14	1C3 : 1C7
3,500	1,100x1,600	2	C4 : C8	L54	2.5	500	500	81	13	2C4 : 2C8
3,900	1,100x1,600	1	C3 : C7	L52	2.2	1,000	750	88	12	1C3 : 1C7
3,900	1,100x1,600	2	C4 : C8	L54	2.5	500	500	83	12	2C4 : 2C8
4,300	1,100x1,600	1	C3 : C7	L52	2.5	1,000	1,000	89	11	1C3 : 1C7
4,300	1,100x1,600	2	C4 : C8	L54	2.5	500	500	75	11	2C4 : 2C8
2,000	1,300x1,800	1	C1 : C5	L50	0.9	625	-	82	18	1C1 : 1C5
2,000	1,300x1,800	2	C2 : C6	L51	1.5	500	-	69	19	2C2 : 2C6
2,500	1,300x1,800	1	C1 : C5	L50	1.1	750	-	76	15	1C1 : 1C5
2,500	1,300x1,800	2	C2 : C6	L51	1.5	500	-	62	22	2C2 : 2C6
3,000	1,300x1,800	1	C1 : C5	L50	1.5	1,000	-	80	12	1C1 : 1C5
3,000	1,300x1,800	2	C2 : C6	L51	1.9	625	-	59	17	2C2 : 2C6

CONNECTION POSITIONS DOUBLE JACKET RS-MO, RA-MO, RS-MO-Q, RA-MO-Q

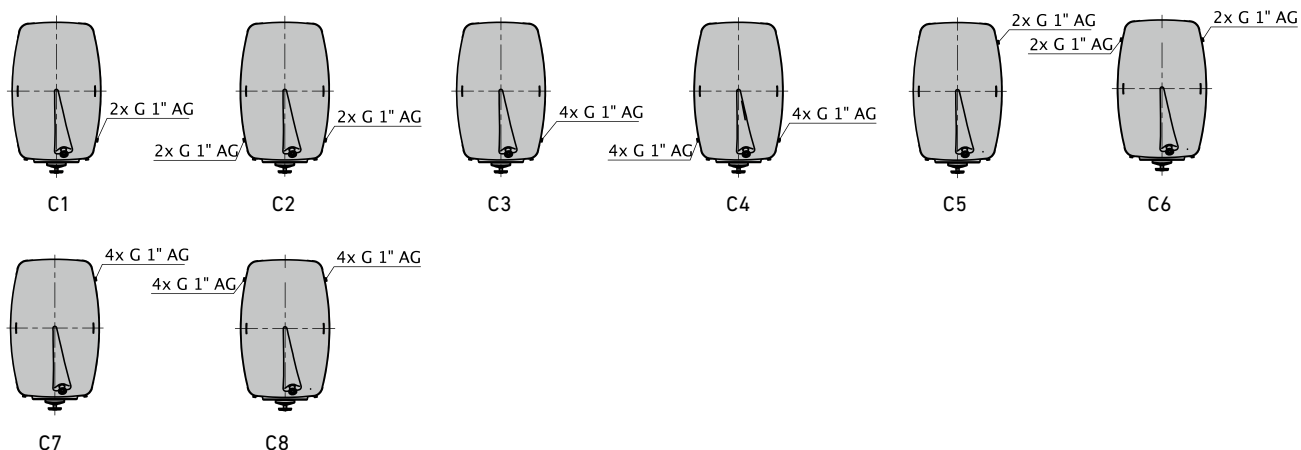

DOUBLE JACKETS RS-MO, RA-MO, RS-MO-Q, RA-MO-Q Ø 1,300 X 1,800–1,400 X 1,400 MM

Capacity	Tank-ø	Version	Connection position	Layout Surface	hd1	hd2	Ho	Hu	Order No.	
liter	mm			m ²	mm	mm	%	%	mounted	
3,500	1,300x1,800	1	C1 : C5	L50	1.9	1,250	-	83	11	1C1 : 1C5
3,500	1,300x1,800	2	C2 : C6	L51	2.3	750	-	59	15	2C2 : 2C6
4,000	1,300x1,800	1	C3 : C7	L52	2.1	750	625	91	15	1C3 : 1C7
4,000	1,300x1,800	2	C2 : C6	L53	2.3	750	-	53	15	2C2 : 2C6
4,500	1,300x1,800	1	C3 : C7	L52	2.3	750	750	87	14	1C3 : 1C7
4,500	1,300x1,800	2	C4 : C8	L54	3.0	500	500	80	13	2C4 : 2C8
5,000	1,300x1,800	1	C3 : C7	L52	2.6	1,000	750	88	12	1C3 : 1C7
5,000	1,300x1,800	2	C4 : C8	L54	3.0	500	500	82	12	2C4 : 2C8
5,600	1,300x1,800	1	C3 : C7	L52	3.0	1,000	1,000	89	11	1C3 : 1C7
5,600	1,300x1,800	2	C4 : C8	L54	3.0	500	500	75	11	2C4 : 2C8
2,600	1,500x2,000	1	C2 : C6	L51	1.6	500	-	69	19	1C2 : 1C6
3,200	1,500x2,000	1	C2 : C6	L51	2.0	625	-	65	15	1C2 : 1C6
3,900	1,500x2,000	1	C2 : C6	L51	2.4	750	-	63	13	1C2 : 1C6
4,500	1,500x2,000	1	C2 : C6	L51	2.4	750	-	59	16	1C2 : 1C6
5,200	1,500x2,000	1	C2 : C6	L53	2.4	750	-	53	15	1C2 : 1C6
5,200	1,500x2,000	2	C4 : C8	L54	3.2	500	500	90	15	2C4 : 2C8
5,800	1,500x2,000	1	C4 : C8	L54	3.2	500	500	80	14	1C4 : 1C8
6,500	1,500x2,000	1	C4 : C8	L54	4.0	750	500	82	12	1C4 : 1C8
7,200	1,500x2,000	1	C4 : C8	L54	4.8	750	750	84	11	1C4 : 1C8
1,500	1,400x1,400	1	C2 : C6	L51	1.0	500	-	79	21	1C2 : 1C6
1,700	1,400x1,400	1	C2 : C6	L51	1.0	500	-	69	18	1C2 : 1C6
2,150	1,400x1,400	1	C2 : C6	L51	1.5	750	-	66	15	1C2 : 1C6
2,600	1,400x1,400	1	C2 : C6	L51	1.5	750	-	63	12	1C2 : 1C6
3,000	1,400x1,400	1	C2 : C6	L51	2.0	1,000	-	68	10	1C2 : 1C6
3,400	1,400x1,400	1	C2 : C6	L53	2.0	1,000	-	60	9	1C2 : 1C6
3,400	1,400x1,400	2	C4 : C8	L54	2.2	625	500	85	21	2C4 : 2C8
3,900	1,400x1,400	1	C2 : C6	L53	2.5	1,250	-	64	8	1C2 : 1C6
3,900	1,400x1,400	2	C4 : C8	L54	2.5	750	500	75	13	2C4 : 2C8
4,350	1,400x1,400	1	C2 : C6	L53	2.5	1,250	-	62	12	1C2 : 1C6
4,350	1,400x1,400	2	C4 : C8	L54	3.0	1,000	500	78	12	2C4 : 2C8
4,800	1,400x1,400	1	C2 : C6	L53	2.5	1,250	-	57	11	1C2 : 1C6
4,800	1,400x1,400	2	C4 : C8	L54	3.0	750	500	84	11	2C4 : 2C8

LAYOUTS DOUBLE JACKET ZKG-3B

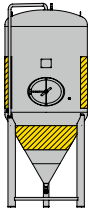

L92

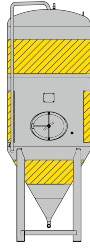

L93

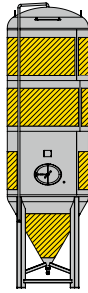

L94

DOUBLE JACKET ZKG-3B Ø 1,000–1,600 MM

Capacity	Tank-Ø	Version	Connection position	Layout	Surface tank shell	Surface conical bottom	hd1	hd2	Order No.
liter	mm				m ²	m ²	mm	mm	
300	*630	1	B1 : B2	L92	0.9	0,3	500	-	1B1 : 1B2
800	1,000	1	F1 : F2	L92	1.0	0,8	500	-	1F1 : 1F2
900	1,000	1	F1 : F2	L92	1.0	0,8	500	-	1F1 : 1F2
1,100	1,000	1	F1 : F2	L92	1.6	0,8	750	-	1F1 : 1F2
1,200	1,000	1	F1 : F2	L92	1.6	0,8	750	-	1F1 : 1F2
1,500	1,000	1	F1 : F2	L92	2.1	0,8	1,000	-	1F1 : 1F2
1,700	1,000	1	F3 : F4	L93	3.1	0,8	750	500	1F3 : 1F4
1,800	1,000	1	F3 : F4	L93	3.1	0,8	750	500	1F3 : 1F4
2,050	1,000	1	F3 : F4	L93	3.1	0,8	1,000	500	1F3 : 1F4
2,250	1,000	1	F3 : F4	L93	4.4	0,8	1,000	750	1F3 : 1F4
1,800	1,200	1	F1 : F2	L92	2.0	1,3	750	-	1F1 : 1F2
2,000	1,200	1	F1 : F2	L92	2.6	1,3	1,000	-	1F1 : 1F2
2,400	1,200	1	F3 : F4	L93	3.8	1,3	750	500	1F3 : 1F4
3,000	1,200	1	F3 : F4	L93	4.2	1,3	1,000	500	1F3 : 1F4
3,300	1,200	1	F3 : F4	L93	5.2	1,3	1,000	750	1F3 : 1F4
2,400	1,400	1	F1 : F2	L92	2.4	2,0	750	-	1F1 : 1F2
3,000	1,400	1	F1 : F2	L92	3.3	2,0	1,000	-	1F1 : 1F2
3,600	1,400	1	F3 : F4	L93	4.6	2,0	750	500	1F3 : 1F4
4,000	1,400	1	F3 : F4	L93	4.6	2,0	750	500	1F3 : 1F4
4,400	1,400	1	F3 : F4	L93	5.5	2,0	1,000	500	1F3 : 1F4
4,700	1,400	1	F3 : F4	L93	6.5	2,0	1,000	750	1F3 : 1F4
5,100	1,400	1	F3 : F4	L93	8.4	2,0	1,250	1,000	1F3 : 1F4
3,500	1,600	1	F1 : F2	L92	2.9	2,3	750	-	1F1 : 1F2
4,000	1,600	1	F1 : F2	L92	3.8	2,3	1,000	-	1F1 : 1F2
4,500	1,600	1	F1 : F2	L92	4.8	2,3	1,250	-	1F1 : 1F2
5,000	1,600	1	F3 : F4	L93	5.3	2,3	750	500	1F3 : 1F4
5,500	1,600	1	F3 : F4	L93	5.3	2,3	750	500	1F3 : 1F4
6,000	1,600	1	F3 : F4	L93	7.5	2,3	1,000	750	1F3 : 1F4
6,500	1,600	1	F3 : F4	L93	7.5	2,3	1,000	750	1F3 : 1F4
7,000	1,600	1	F3 : F4	L93	9.7	2,3	1,250	1,000	1F3 : 1F4
7,500	1,600	1	F3 : F4	L93	9.7	2,3	1,250	1,000	1F3 : 1F4

* only available as a FD tank

CONNECTION POSITIONEN DOUBLE JACKETS ZKG-3B

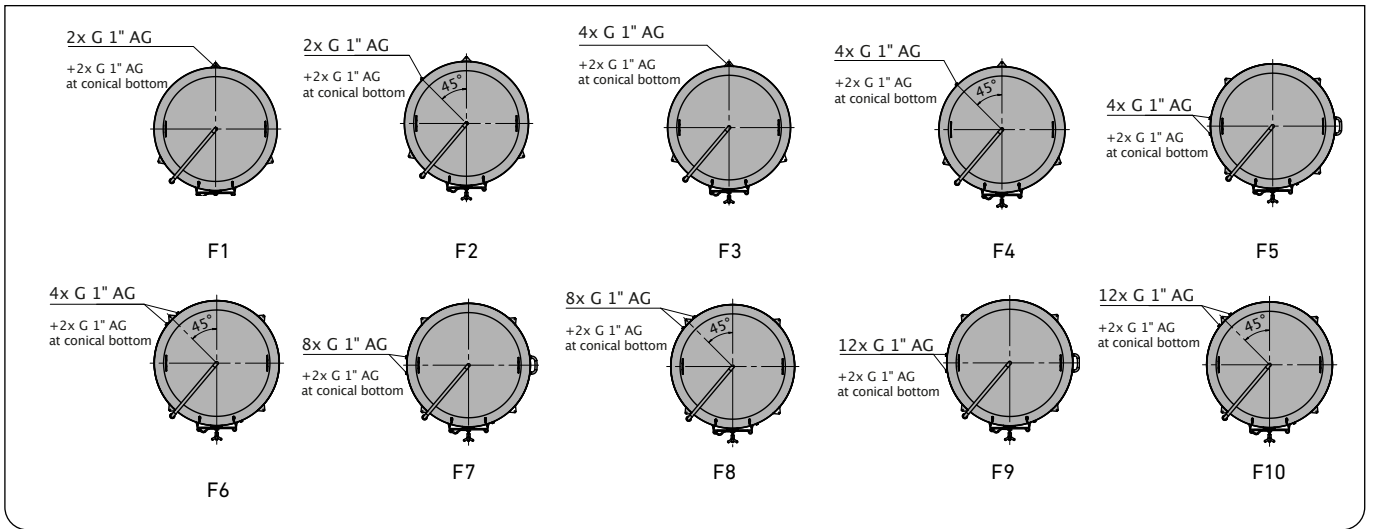

DOUBLE JACKET ZKG-3B Ø 1,800–2,200 MM

Capacity Tank-ø		Version	Connection position		Layout	Surface tank shell	Surface conical bottom	hd1	hd2	hd3	Order No.
liter	mm					m ²	m ²	mm	mm	mm	
4,750	1,800	1	F1	F2	L92	3.1	3.0	750	-	-	1F1 : 1F2
5,400	1,800	1	F1	F2	L92	4.5	3.0	1,000	-	-	1F1 : 1F2
6,000	1,800	1	F1	F2	L92	4.5	3.0	1,000	-	-	1F1 : 1F2
6,600	1,800	1	F3	F4	L93	5.9	3.0	750	500	-	1F3 : 1F4
7,200	1,800	1	F3	F4	L93	5.9	3.0	750	500	-	1F3 : 1F4
7,800	1,800	1	F3	F4	L93	7.3	3.0	750	750	-	1F3 : 1F4
8,500	1,800	1	F3	F4	L93	8.7	3.0	1,000	750	-	1F3 : 1F4
9,100	1,800	1	F3	F4	L93	8.7	3.0	1,000	750	-	1F3 : 1F4
9,700	1,800	1	F3	F4	L93	11.5	3.0	1,000	1,000	-	1F3 : 1F4
6,200	2,000	1	F1	F2	L92	3.8	3.5	750	-	-	1F1 : 1F2
6,900	2,000	1	F1	F2	L92	5.1	3.5	1,000	-	-	1F1 : 1F2
7,700	2,000	1	F1	F2	L92	5.1	3.5	1,000	-	-	1F1 : 1F2
8,500	2,000	1	F3	F4	L93	6.9	3.5	750	500	-	1F3 : 1F4
9,200	2,000	1	F3	F4	L93	6.9	3.5	750	500	-	1F3 : 1F4
10,000	2,000	1	F3	F4	L93	8.4	3.5	750	750	-	1F3 : 1F4
10,800	2,000	1	F3	F4	L93	9.7	3.5	1,000	750	-	1F3 : 1F4
11,500	2,000	1	F3	F4	L93	9.7	3.5	1,000	750	-	1F3 : 1F4
12,300	2,000	1	F3	F4	L93	11.3	3.5	1,000	1,000	-	1F3 : 1F4
7,800	2,200	1	F5	F6	L92	3.7	2.8	750	-	-	1F5 : 1F6
8,800	2,200	1	F5	F6	L92	5.0	2.8	1,000	-	-	1F5 : 1F6
9,700	2,200	1	F5	F6	L92	6.2	2.8	1,250	-	-	1F5 : 1F6
10,500	2,200	1	F7	F8	L93	7.0	2.8	750	500	-	1F7 : 1F8
11,500	2,200	1	F7	F8	L93	7.0	2.8	750	500	-	1F7 : 1F8
12,500	2,200	1	F7	F8	L93	8.3	2.8	1,000	500	-	1F7 : 1F8
14,300	2,200	1	F7	F8	L93	10.0	2.8	1,000	750	-	1F7 : 1F8
15,200	2,200	1	F7	F8	L93	10.0	2.8	1,000	750	-	1F7 : 1F8
17,200	2,200	1	F7	F8	L93	11.7	2.8	1,000	1,000	-	1F7 : 1F8
18,000	2,200	1	F7	F8	L93	11.7	2.8	1,000	1,000	-	1F7 : 1F8
19,000	2,200	1	F9	F10	L94	15.0	2.8	1,000	750	750	1F9 : 1F10
20,000	2,200	1	F9	F10	L94	15.0	2.8	1,000	750	750	1F9 : 1F10

LAYOUTS DOUBLE JACKETS FS-MO-1B / FS-MO-3B

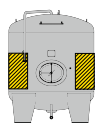

L95

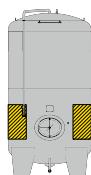

L105

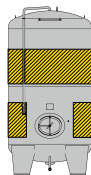

L96

DOUBLE JACKETS FS-MO-1B / FS-MO-3B Ø 630–1,600 MM

Capacity	Tank-ø	Version	Connection position	Layout	Surface	hd1	hd2	hd3	Order No.
liter	mm				m ²	mm	mm	%	mounted
280	630	1	B1 : B2	L95	0.9	500	-	-	1B : 1B2
600	1.000	1	F11 : F12	L95	1.0	500	-	-	1F11 : 1F12
750	1.000	1	F11 : F12	L95	1.0	500	-	-	1F11 : 1F12
950	1.000	1	F11 : F12	L95	1.6	750	-	-	1F11 : 1F12
1.150	1.000	1	F11 : F12	L95	1.6	750	-	-	1F11 : 1F12
1.350	1.000	1	F11 : F12	L95	1.6	750	-	-	1F11 : 1F12
1.500	1.000	1	F11 : F12	L105	1.6	750	-	-	1F11 : 1F12
1.750	1.000	1	F11 : F12	L105	1.6	750	-	-	1F11 : 1F12
1.900	1.000	1	F11 : F12	L105	2.1	1.000	-	-	1F11 : 1F12
2.100	1.000	1	F11 : F12	L105	2.1	1.000	-	-	1F11 : 1F12
1.450	1.200	1	F11 : F12	L95	1.3	500	-	-	1F11 : 1F12
1.750	1.200	1	F11 : F12	L95	2.0	750	-	-	1F11 : 1F12
1.800	1.200	1	F11 : F12	L95	2.0	750	-	-	1F11 : 1F12
2.000	1.200	1	F11 : F12	L95	2.0	750	-	-	1F11 : 1F12
2.250	1.200	1	F11 : F12	L105	2.0	750	-	-	1F11 : 1F12
2.400	1.200	1	F11 : F12	L105	2.0	750	-	-	1F11 : 1F12
2.550	1.200	1	F11 : F12	L105	2.0	750	-	-	1F11 : 1F12
2.800	1.200	1	F11 : F12	L105	2.6	1.000	-	-	1F11 : 1F12
3.100	1.200	1	F11 : F12	L105	2.6	1.000	-	-	1F11 : 1F12
2.100	1.400	1	F11 : F12	L95	2.4	750	-	-	1F11 : 1F12
2.400	1.400	1	F11 : F12	L95	2.4	750	-	-	1F11 : 1F12
2.450	1.400	1	F11 : F12	L95	2.4	750	-	-	1F11 : 1F12
2.850	1.400	1	F11 : F12	L95	2.4	750	-	-	1F11 : 1F12
3.000	1.400	1	F11 : F12	L95	2.4	750	-	-	1F11 : 1F12
3.200	1.400	1	F11 : F12	L105	2.4	750	-	-	1F11 : 1F12
3.600	1.400	1	F11 : F12	L105	2.4	750	-	-	1F11 : 1F12
4.000	1.400	1	F11 : F12	L105	3.3	1.000	-	-	1F11 : 1F12
4.300	1.400	1	F11 : F12	L105	3.3	1.000	-	-	1F11 : 1F12
4.700	1.400	1	F11 : F12	L105	4.1	1.250	-	-	1F11 : 1F12
5.100	1.400	1	F11 : F12	L105	4.1	1.250	-	-	1F11 : 1F12
2.800	1.600	1	F11 : F12	L95	2.9	750	-	-	1F11 : 1F12
3.050	1.600	1	F11 : F12	L95	2.9	750	-	-	1F11 : 1F12
3.300	1.600	1	F11 : F12	L95	2.9	750	-	-	1F11 : 1F12
3.500	1.600	1	F11 : F12	L95	2.9	750	-	-	1F11 : 1F12
3.800	1.600	1	F11 : F12	L95	2.9	750	-	-	1F11 : 1F12
4.000	1.600	1	F11 : F12	L95	2.9	750	-	-	1F11 : 1F12
4.300	1.600	1	F11 : F12	L95	2.9	750	-	-	1F11 : 1F12
4.500	1.600	1	F11 : F12	L105	2.9	750	-	-	1F11 : 1F12
4.800	1.600	1	F11 : F12	L105	2.9	750	-	-	1F11 : 1F12
5.000	1.600	1	F13 : F14	L96	5.4	750	500	-	1F13 : 1F14
5.300	1.600	1	F13 : F14	L96	5.4	750	500	-	1F13 : 1F14
5.500	1.600	1	F13 : F14	L96	5.4	750	500	-	1F13 : 1F14
5.800	1.600	1	F13 : F14	L96	5.4	750	500	-	1F13 : 1F14
6.000	1.600	1	F13 : F14	L96	5.4	750	500	-	1F13 : 1F14
6.300	1.600	1	F13 : F14	L96	5.4	750	500	-	1F13 : 1F14
6.500	1.600	1	F13 : F14	L96	5.4	750	500	-	1F13 : 1F14
6.800	1.600	1	F13 : F14	L96	5.4	750	500	-	1F13 : 1F14

CONNECTION POSITIONS DOUBLE JACKETS FS-MO-1B / FS-MO-3B

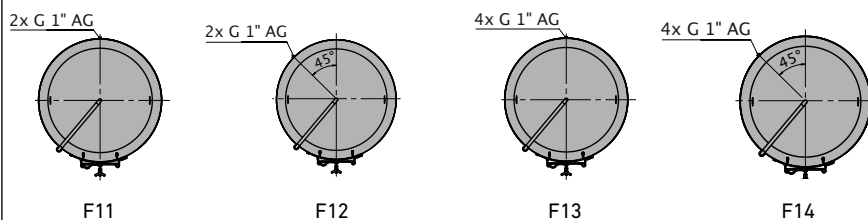

DOUBLE JACKETS FS-MO-1B / FS-MO-3B Ø 1,800–2,000 MM

Capacity liter	Tank- \varnothing mm	Version	Connection position	Layout Surface	hd1 mm	hd2 mm	hd3 %	Order No. mounted
3,700	1,800	1	F11 : F12	L95	750	-	-	1F11 : 1F12
4,000	1,800	1	F11 : F12	L95	750	-	-	1F11 : 1F12
4,300	1,800	1	F11 : F12	L95	750	-	-	1F11 : 1F12
4,700	1,800	1	F11 : F12	L95	750	-	-	1F11 : 1F12
5,000	1,800	1	F11 : F12	L95	750	-	-	1F11 : 1F12
5,300	1,800	1	F11 : F12	L95	750	-	-	1F11 : 1F12
5,500	1,800	1	F13 : F14	L96	750	500	-	1F13 : 1F14
5,900	1,800	1	F13 : F14	L96	750	500	-	1F13 : 1F14
6,200	1,800	1	F13 : F14	L96	750	500	-	1F13 : 1F14
6,500	1,800	1	F13 : F14	L96	750	500	-	1F13 : 1F14
6,800	1,800	1	F13 : F14	L96	750	500	-	1F13 : 1F14
7,100	1,800	1	F13 : F14	L96	750	500	-	1F13 : 1F14
7,400	1,800	1	F13 : F14	L96	750	500	-	1F13 : 1F14
7,800	1,800	1	F13 : F14	L96	750	500	-	1F13 : 1F14
8,100	1,800	1	F13 : F14	L96	1,000	500	-	1F13 : 1F14
8,400	1,800	1	F13 : F14	L96	1,000	500	-	1F13 : 1F14
8,700	1,800	1	F13 : F14	L96	1,000	500	-	1F13 : 1F14
4,700	2,000	1	F11 : F12	L95	750	-	-	1F11 : 1F12
5,200	2,000	1	F11 : F12	L95	750	-	-	1F11 : 1F12
5,500	2,000	1	F11 : F12	L95	750	-	-	1F11 : 1F12
6,000	2,000	1	F11 : F12	L95	750	-	-	1F11 : 1F12
6,300	2,000	1	F11 : F12	L95	750	-	-	1F11 : 1F12
6,800	2,000	1	F11 : F12	L95	750	-	-	1F11 : 1F12
7,000	2,000	1	F11 : F12	L105	750	-	-	1F11 : 1F12
7,500	2,000	1	F11 : F12	L105	750	-	-	1F11 : 1F12
7,800	2,000	1	F11 : F12	L105	750	-	-	1F11 : 1F12
8,300	2,000	1	F13 : F14	L96	750	500	-	1F13 : 1F14
8,600	2,000	1	F13 : F14	L96	750	500	-	1F13 : 1F14
9,100	2,000	1	F13 : F14	L96	750	500	-	1F13 : 1F14
9,400	2,000	1	F13 : F14	L96	750	500	-	1F13 : 1F14
9,900	2,000	1	F13 : F14	L96	750	500	-	1F13 : 1F14
10,100	2,000	1	F13 : F14	L96	1,000	500	-	1F13 : 1F14
10,600	2,000	1	F13 : F14	L96	1,000	500	-	1F13 : 1F14
10,900	2,000	1	F13 : F14	L96	1,000	500	-	1F13 : 1F14

LAYOUTS DOUBLE JACKETS FS-MO-1B / FS-MO-3B

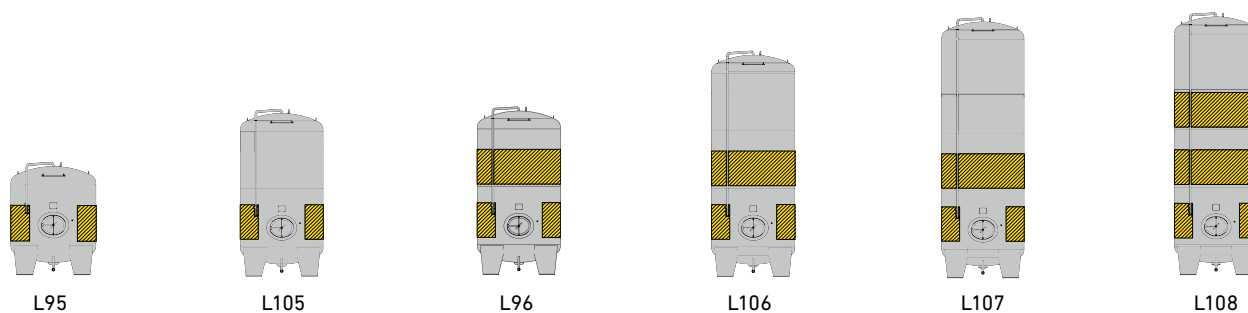

DOUBLE JACKETS FS-MO-1B / FS-MO-3B Ø 2,200–2,400 MM

Capacity liter	Tank- \emptyset mm	Version	Connection position	Layout	Surface m ²	hd1 mm	hd2 mm	hd3 %	Order No. mounted
6,500	2,200	1	A3 : A4	L95	3.7	750	-	-	1A3 : 1A4
7,400	2,200	1	A3 : A4	L95	4.9	1,000	-	-	1A3 : 1A4
8,400	2,200	1	A3 : A4	L105	4.9	1,000	-	-	1A3 : 1A4
9,200	2,200	1	D3 : D4	L96	7.0	750	500	-	1D3 : 1D4
10,200	2,200	1	D3 : D4	L96	7.0	750	500	-	1D3 : 1D4
12,000	2,200	1	D3 : D4	L96	8.2	1,000	500	-	1D3 : 1D4
14,000	2,200	1	D3 : D4	L96	8.2	1,000	500	-	1D3 : 1D4
15,000	2,200	1	D3 : D4	L106	9.1	1,000	625	-	1D3 : 1D4
16,000	2,200	1	D3 : D4	L106	11.2	1,250	750	-	1D3 : 1D4
16,800	2,200	1	D3 : D4	L106	11.2	1,250	750	-	1D3 : 1D4
18,500	2,200	1	D3 : D4	L106	11.2	1,250	750	-	1D3 : 1D4
19,000	2,200	1	D3 : D4	L106	11.6	1,000	1,000	-	1D3 : 1D4
20,000	2,200	1	D3 : D4	L106	11.6	1,000	1,000	-	1D3 : 1D4
7,800	2,400	1	A3 : A4	L95	4.1	750	-	-	1A3 : 1A4
8,000	2,400	1	A3 : A4	L95	4.1	750	-	-	1A3 : 1A4
8,900	2,400	1	A3 : A4	L95	5.5	1,000	-	-	1A3 : 1A4
9,200	2,400	1	A3 : A4	L95	5.5	1,000	-	-	1A3 : 1A4
10,000	2,400	1	A3 : A4	L95	5.5	1,000	-	-	1A3 : 1A4
10,300	2,400	1	A3 : A4	L95	5.5	1,000	-	-	1A3 : 1A4
12,200	2,400	1	D3 : D4	L96	9.2	1,000	500	-	1D3 : 1D4
12,500	2,400	1	D3 : D4	L96	9.2	1,000	500	-	1D3 : 1D4
14,500	2,400	1	D3 : D4	L96	9.2	1,000	500	-	1D3 : 1D4
15,800	2,400	1	D3 : D4	L96	10.0	1,000	625	-	1D3 : 1D4
16,200	2,400	1	D3 : D4	L96	10.0	1,000	625	-	1D3 : 1D4
17,000	2,400	1	D3 : D4	L96	10.0	1,000	625	-	1D3 : 1D4
17,300	2,400	1	D3 : D4	L96	10.0	1,000	625	-	1D3 : 1D4
19,200	2,400	1	D3 : D4	L106	10.0	1,000	625	-	1D3 : 1D4
19,500	2,400	1	D3 : D4	L106	10.0	1,000	625	-	1D3 : 1D4
20,400	2,400	1	D3 : D4	L106	10.0	1,000	625	-	1D3 : 1D4
20,500	2,400	1	D3 : D4	L106	10.0	1,000	625	-	1D3 : 1D4
22,500	2,400	1	D3 : D4	L106	12.7	1,000	1,000	-	1D3 : 1D4
23,000	2,400	1	D3 : D4	L106	12.7	1,000	1,000	-	1D3 : 1D4
23,500	2,400	1	D3 : D4	L106	12.7	1,000	1,000	-	1D3 : 1D4
24,000	2,400	1	D3 : D4	L107	12.7	1,000	1,000	-	1D3 : 1D4
24,800	2,400	1	D3 : D4	L107	12.7	1,000	1,000	-	1D3 : 1D4
25,000	2,400	1	D3 : D4	L107	12.7	1,000	1,000	-	1D3 : 1D4

D3 = combination A3/B5 D4 = combination A4/B6

CONNECTION POSITIONS DOUBLE JACKETS FS-MO-1B / FS-MO-3B

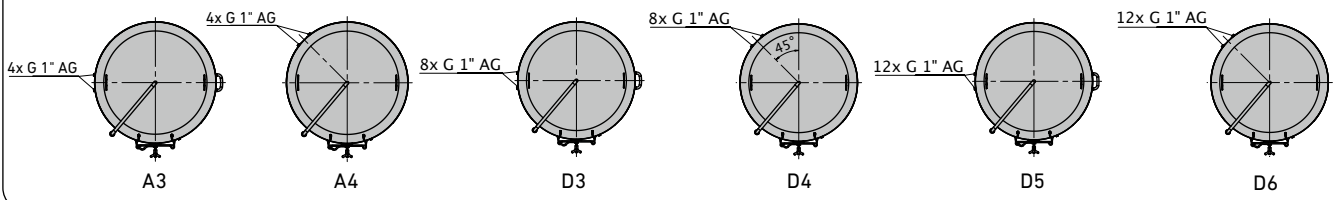

DOUBLE JACKETS FS-MO-1B / FS-MO-3B Ø 2,600–2,800 MM

Capacity liter	Tank- \varnothing mm	Version	Connection position	Layout Surface m ²	hd1 mm	hd2 mm	hd3 %	Order No. mounted
9,900	2,600	1	A3 : A4	L95	5.9	1,000	-	1A3 : 1A4
10,200	2,600	1	A3 : A4	L95	5.9	1,000	-	1A3 : 1A4
11,200	2,600	1	A3 : A4	L95	5.9	1,000	-	1A3 : 1A4
11,500	2,600	1	A3 : A4	L95	5.9	1,000	-	1A3 : 1A4
12,500	2,600	1	A3 : A4	L95	5.9	1,000	-	1A3 : 1A4
12,600	2,600	1	A3 : A4	L95	5.9	1,000	-	1A3 : 1A4
13,600	2,600	1	D3 : D4	L96	8.3	750	500	1D3 : 1D4
14,000	2,600	1	D3 : D4	L96	8.3	750	500	1D3 : 1D4
16,500	2,600	1	D3 : D4	L96	9.8	1,000	500	1D3 : 1D4
16,600	2,600	1	D3 : D4	L96	9.8	1,000	500	1D3 : 1D4
17,500	2,600	1	D3 : D4	L96	9.8	1,000	500	1D3 : 1D4
18,000	2,600	1	D3 : D4	L96	9.8	1,000	500	1D3 : 1D4
20,300	2,600	1	D3 : D4	L106	11.8	1,000	750	1D3 : 1D4
20,500	2,600	1	D3 : D4	L106	11.8	1,000	750	1D3 : 1D4
21,500	2,600	1	D3 : D4	L106	11.8	1,000	750	1D3 : 1D4
22,000	2,600	1	D3 : D4	L106	11.8	1,000	750	1D3 : 1D4
24,200	2,600	1	D3 : D4	L106	13.8	1,000	1,000	1D3 : 1D4
24,500	2,600	1	D3 : D4	L106	13.8	1,000	1,000	1D3 : 1D4
25,500	2,600	1	D3 : D4	L106	13.8	1,000	1,000	1D3 : 1D4
26,000	2,600	1	D3 : D4	L106	13.8	1,000	1,000	1D3 : 1D4
27,000	2,600	1	D3 : D4	L106	13.8	1,000	1,000	1D3 : 1D4
28,000	2,600	1	D3 : D4	L106	13.8	1,000	1,000	1D3 : 1D4
28,500	2,600	1	D3 : D4	L106	13.8	1,000	1,000	1D3 : 1D4
29,500	2,600	1	D3 : D4	L107	13.8	1,000	1,000	1D3 : 1D4
30,000	2,600	1	D3 : D4	L107	13.8	1,000	1,000	1D3 : 1D4
32,000	2,600	1	D3 : D4	L107	13.8	1,000	1,000	1D3 : 1D4
32,500	2,600	1	D3 : D4	L107	13.8	1,000	1,000	1D3 : 1D4
11,800	2,800	1	A3 : A4	L95	6.4	1,000	-	1A3 : 1A4
12,100	2,800	1	A3 : A4	L95	6.4	1,000	-	1A3 : 1A4
13,400	2,800	1	A3 : A4	L95	7.9	1,250	-	1A3 : 1A4
13,600	2,800	1	A3 : A4	L95	7.9	1,250	-	1A3 : 1A4
15,000	2,800	1	D3 : D4	L96	9.0	750	500	1D3 : 1D4
16,500	2,800	1	D3 : D4	L96	9.0	750	500	1D3 : 1D4
18,000	2,800	1	D3 : D4	L96	10.7	1,000	500	1D3 : 1D4
18,200	2,800	1	D3 : D4	L96	10.7	1,000	500	1D3 : 1D4
21,000	2,800	1	D3 : D4	L96	12.2	1,250	500	1D3 : 1D4
21,200	2,800	1	D3 : D4	L96	12.2	1,250	500	1D3 : 1D4
22,500	2,800	1	D3 : D4	L96	12.2	1,250	500	1D3 : 1D4
22,800	2,800	1	D3 : D4	L96	12.2	1,250	500	1D3 : 1D4
24,000	2,800	1	D3 : D4	L96	12.8	1,000	750	1D3 : 1D4
24,200	2,800	1	D3 : D4	L106	12.8	1,000	750	1D3 : 1D4
25,500	2,800	1	D3 : D4	L106	12.8	1,000	750	1D3 : 1D4
25,800	2,800	1	D3 : D4	L106	15.0	1,000	1,000	1D3 : 1D4
27,000	2,800	1	D3 : D4	L106	15.0	1,000	1,000	1D3 : 1D4
27,400	2,800	1	D3 : D4	L106	15.0	1,000	1,000	1D3 : 1D4
28,500	2,800	1	D3 : D4	L106	15.0	1,000	1,000	1D3 : 1D4
29,000	2,800	1	D3 : D4	L106	16.5	1,250	1,000	1D3 : 1D4
31,500	2,800	1	D3 : D4	L106	16.5	1,250	1,000	1D3 : 1D4
32,000	2,800	1	D3 : D4	L106	16.5	1,250	1,000	1D3 : 1D4
33,000	2,800	1	D3 : D4	L106	16.5	1,250	1,000	1D3 : 1D4
33,500	2,800	1	D5 : D6	L108	19.2	1,000	750	1D5 : 1D6
34,500	2,800	1	D5 : D6	L108	19.2	1,000	750	1D5 : 1D6
35,000	2,800	1	D5 : D6	L108	19.2	1,000	750	1D5 : 1D6

D5 = combination A3/B7, D6 = combination A4/B8

LAYOUTS DOUBLE JACKETS FS-MO-1B / FS-MO-3B

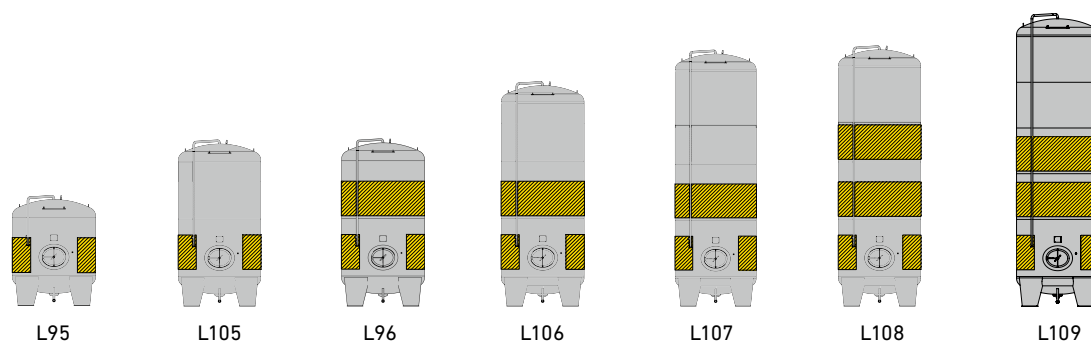

L95

L105

L96

L106

L107

L108

L109

DOUBLE JACKETS FS-MO-1B / FS-MO-3B Ø 2,800–3,000 MM

Capacity liter	Tank-ø mm	Version	Connection position	Layout	Surface m ²	hd1 mm	hd2 mm	hd3 %	Order No. mounted
36,000	2,800	1	D5 : D6	L108	19.2	1,000	750	750	1D5 : 1D6
36,500	2,800	1	D5 : D6	L108	19.2	1,000	750	750	1D5 : 1D6
37,500	2,800	1	D5 : D6	L108	19.2	1,000	750	750	1D5 : 1D6
38,000	2,800	1	D5 : D6	L108	19.2	1,000	750	750	1D5 : 1D6
39,000	2,800	1	D5 : D6	L108	19.2	1,000	750	750	1D5 : 1D6
39,500	2,800	1	D5 : D6	L108	19.2	1,000	750	750	1D5 : 1D6
40,800	2,800	1	D5 : D6	L108	19.2	1,000	750	750	1D5 : 1D6
41,000	2,800	1	D5 : D6	L108	19.2	1,000	750	750	1D5 : 1D6
14,100	3,000	1	A3 : A4	L95	6.9	1,000	-	-	1A3 : 1A4
14,300	3,000	1	A3 : A4	L95	6.9	1,000	-	-	1A3 : 1A4
16,000	3,000	1	A3 : A4	L95	8.5	1,250	-	-	1A3 : 1A4
17,500	3,000	1	A3 : A4	L95	8.5	1,250	-	-	1A3 : 1A4
18,000	3,000	1	D3 : D4	L96	9.7	750	500	-	1D3 : 1D4
19,500	3,000	1	D3 : D4	L96	9.7	750	500	-	1D3 : 1D4
21,000	3,000	1	D3 : D4	L96	9.7	750	500	-	1D3 : 1D4
21,500	3,000	1	D3 : D4	L96	11.5	1,000	500	-	1D3 : 1D4
23,000	3,000	1	D3 : D4	L96	11.5	1,000	500	-	1D3 : 1D4
24,500	3,000	1	D3 : D4	L96	11.5	1,000	500	-	1D3 : 1D4
25,000	3,000	1	D3 : D4	L96	13.1	1,250	500	-	1D3 : 1D4
26,500	3,000	1	D3 : D4	L96	13.1	1,250	500	-	1D3 : 1D4
28,000	3,000	1	D3 : D4	L96	13.1	1,250	500	-	1D3 : 1D4
28,500	3,000	1	D3 : D4	L106	13.8	1,000	750	-	1D3 : 1D4
30,000	3,000	1	D3 : D4	L106	16.1	1,000	1,000	-	1D3 : 1D4
31,500	3,000	1	D3 : D4	L106	16.1	1,000	1,000	-	1D3 : 1D4
32,000	3,000	1	D3 : D4	L106	16.1	1,000	1,000	-	1D3 : 1D4
33,500	3,000	1	D3 : D4	L106	16.1	1,000	1,000	-	1D3 : 1D4
33,800	3,000	1	D3 : D4	L106	16.1	1,000	1,000	-	1D3 : 1D4
35,000	3,000	1	D3 : D4	L106	16.1	1,000	1,000	-	1D3 : 1D4
35,500	3,000	1	D3 : D4	L106	17.7	1,250	1,000	-	1D3 : 1D4
37,000	3,000	1	D3 : D4	L106	17.7	1,250	1,000	-	1D3 : 1D4
37,200	3,000	1	D3 : D4	L106	17.7	1,250	1,000	-	1D3 : 1D4
38,500	3,000	1	D3 : D4	L106	17.7	1,250	1,000	-	1D3 : 1D4
39,000	3,000	1	D5 : D6	L108	20.7	1,000	750	750	1D5 : 1D6
40,500	3,000	1	D5 : D6	L108	20.7	1,000	750	750	1D5 : 1D6
42,000	3,000	1	D5 : D6	L108	20.7	1,000	750	750	1D5 : 1D6
42,500	3,000	1	D5 : D6	L108	20.7	1,000	750	750	1D5 : 1D6
44,000	3,000	1	D5 : D6	L108	20.7	1,000	750	750	1D5 : 1D6
44,200	3,000	1	D5 : D6	L108	20.7	1,000	750	750	1D5 : 1D6
45,500	3,000	1	D5 : D6	L108	20.7	1,000	750	750	1D5 : 1D6
46,000	3,000	1	D5 : D6	L108	20.7	1,000	750	750	1D5 : 1D6
47,500	3,000	1	D5 : D6	L108	23.0	1,000	1,000	750	1D5 : 1D6
47,800	3,000	1	D5 : D6	L108	23.0	1,000	1,000	750	1D5 : 1D6
49,000	3,000	1	D5 : D6	L108	23.0	1,000	1,000	750	1D5 : 1D6
49,500	3,000	1	D5 : D6	L109	23.0	1,000	1,000	750	1D5 : 1D6

D5 = combination A3/B7, D6 = combination A4/B8

CONNECTION POSITIONS DOUBLE JACKETS FS-MO-1B / FS-MO-3B

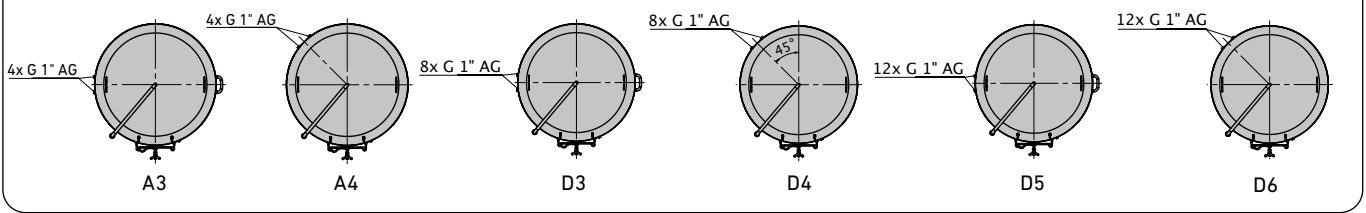

LAYOUTS / CONNECTION POSITIONS DOUBLE JACKET PRESSURE TANK FS-MO-8B

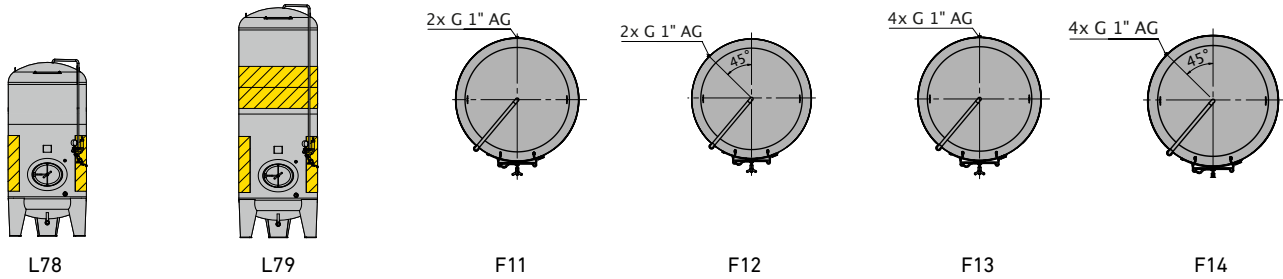

DOUBLE JACKET PRESSURE TANK FS-MO-8B Ø 1,000–1,600 MM

Capacity liter	Tank- \varnothing mm	Version	Connection position	Layout	Surface m ²	hd1 mm	hd2 mm	Order No. mounted
1,000	1,000	1	F11 : F12	L78	1.0	500	-	1F11 : 1F12
1,200	1,000	1	F11 : F12	L78	1.5	750	-	1F11 : 1F12
1,400	1,000	1	F11 : F12	L78	1.5	750	-	1F11 : 1F12
1,600	1,000	1	F11 : F12	L78	1.5	750	-	1F11 : 1F12
1,800	1,000	1	F11 : F12	L78	1.5	750	-	1F11 : 1F12
2,000	1,000	1	F11 : F12	L78	2.0	1,000	-	1F11 : 1F12
2,150	1,000	1	F11 : F12	L78	2.0	1,000	-	1F11 : 1F12
1,500	1,200	1	F11 : F12	L78	1.3	500	-	1F11 : 1F12
1,800	1,200	1	F11 : F12	L78	2.0	750	-	1F11 : 1F12
2,100	1,200	1	F11 : F12	L78	2.0	750	-	1F11 : 1F12
2,400	1,200	1	F11 : F12	L78	2.0	750	-	1F11 : 1F12
2,600	1,200	1	F11 : F12	L78	2.0	750	-	1F11 : 1F12
2,900	1,200	1	F11 : F12	L78	2.6	1,000	-	1F11 : 1F12
3,200	1,200	1	F11 : F12	L78	2.6	1,000	-	1F11 : 1F12
2,200	1,400	1	F11 : F12	L78	2.4	750	-	1F11 : 1F12
2,600	1,400	1	F11 : F12	L78	2.4	750	-	1F11 : 1F12
3,000	1,400	1	F11 : F12	L78	2.4	750	-	1F11 : 1F12
3,400	1,400	1	F11 : F12	L78	2.4	750	-	1F11 : 1F12
3,700	1,400	1	F11 : F12	L78	2.4	750	-	1F11 : 1F12
4,100	1,400	1	F11 : F12	L78	3.2	1,000	-	1F11 : 1F12
4,500	1,400	1	F11 : F12	L78	3.2	1,000	-	1F11 : 1F12
4,900	1,400	1	F11 : F12	L78	4.0	1,250	-	1F11 : 1F12
5,200	1,400	1	F11 : F12	L78	4.0	1,250	-	1F11 : 1F12
3,000	1,600	1	F11 : F12	L78	2.9	750	-	1F11 : 1F12
3,500	1,600	1	F11 : F12	L78	2.9	750	-	1F11 : 1F12
4,000	1,600	1	F11 : F12	L78	2.9	750	-	1F11 : 1F12
4,500	1,600	1	F11 : F12	L78	2.9	750	-	1F11 : 1F12
5,000	1,600	1	F11 : F12	L78	2.9	750	-	1F11 : 1F12
5,500	1,600	1	F13 : F14	L79	5.4	750	500	1F13 : 1F14
6,000	1,600	1	F13 : F14	L79	5.4	750	500	1F13 : 1F14
6,500	1,600	1	F13 : F14	L79	5.4	750	500	1F13 : 1F14
7,000	1,600	1	F13 : F14	L79	5.4	750	500	1F13 : 1F14
10,000	1,600	1	F13 : F14	L79	7.4	750	750	1F13 : 1F14

Heat exchange panels for cooling / heating

HEAT EXCHANGE PANELS FOR COOLING / HEATING

- Low-priced solution – also suitable for retrofit
- Monitoring is possible via manual or automatic regulation (not included in the delivery scope)
- Simple installation
- Drilled holes in the tank top \varnothing 22 mm
- Operating pressure 5 bar
- Material: AISI 304 stainless steel high gloss polished
- Completely threaded connection

Range of use

- Moderated fermentation
- Start temperature for fermentation
- Cold stabilisation
- Acid reduction

Cooling executed via

- Tap water
- Cooling unit

Heating executed via

- Boiler
- Hot-water apparatus

- Due to their spot welding Speidel's exchanging plates for cooling and heating are constructed in such a way that perfect transmission of energy via the swirling of the coolant medium is guaranteed.
- Available only for Speidel tanks FS-MO / AS-MO with \varnothing of 820 mm to 2,000 mm and RS-MO / RA-MO. Can not be used for the base tank in case of tank stack and for the lower respectively middle tank compartment of multi-compartment tanks.

INSTALLATION OF COLD / HOT EXCHANGE PLATE

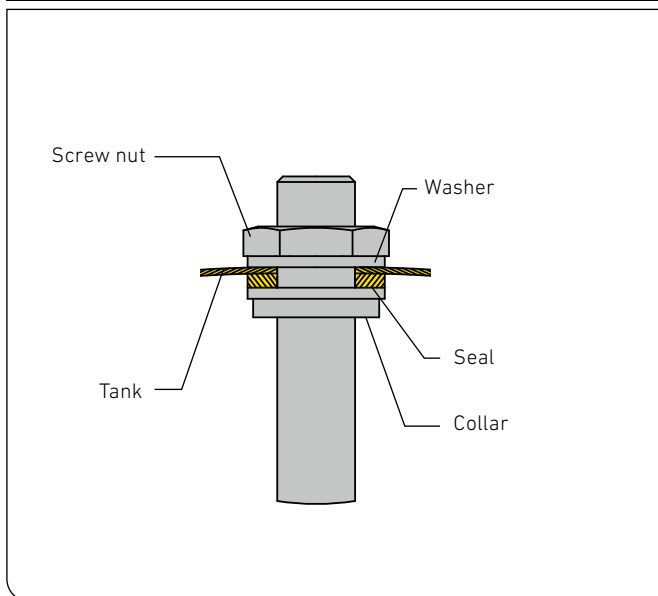

DIMENSIONS OF COLD / HOT EXCHANGE PLATE

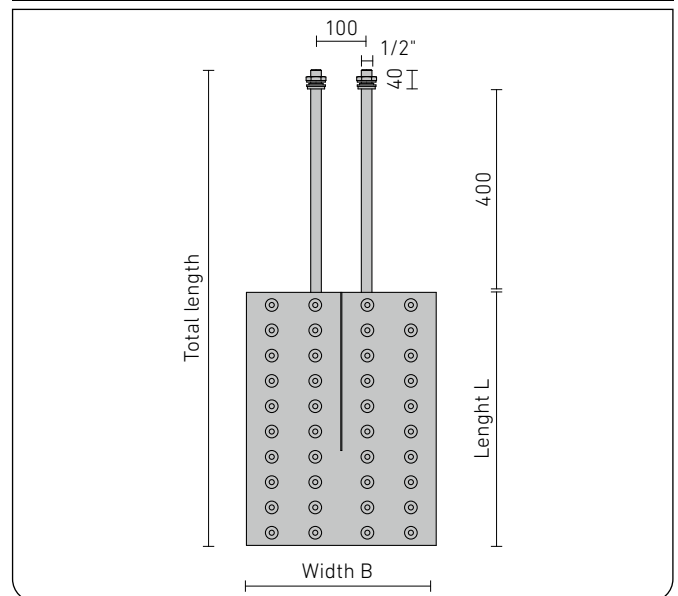

HEAT EXCHANGE PANELS FOR COOLING / HEATING

Capacity	Sizes	Total length	Exchange Surface	Order No.
liter	LxBmm	mm	m ²	loose
525 bis 2,000*	550x375	940	0.38	68641
3,000	750x375	1,190	0.56	68642
4,000*	1,000x375	1,440	0.75	68643
6,000	1,500x375	1,940	1.13	68644
8,000	1,950x375	2,390	1.46	68645
10,000	2,450x375	2,890	1.84	68646
12,000	2,950x375	3,390	2.21	68647
16,000	3,950x375	4,390	2.96	68648

* Not to be used at a tank diameter of 2,000 mm with a capacity of 3,000 liter respectively 3,800 liter – choose the subsequently following smaller size

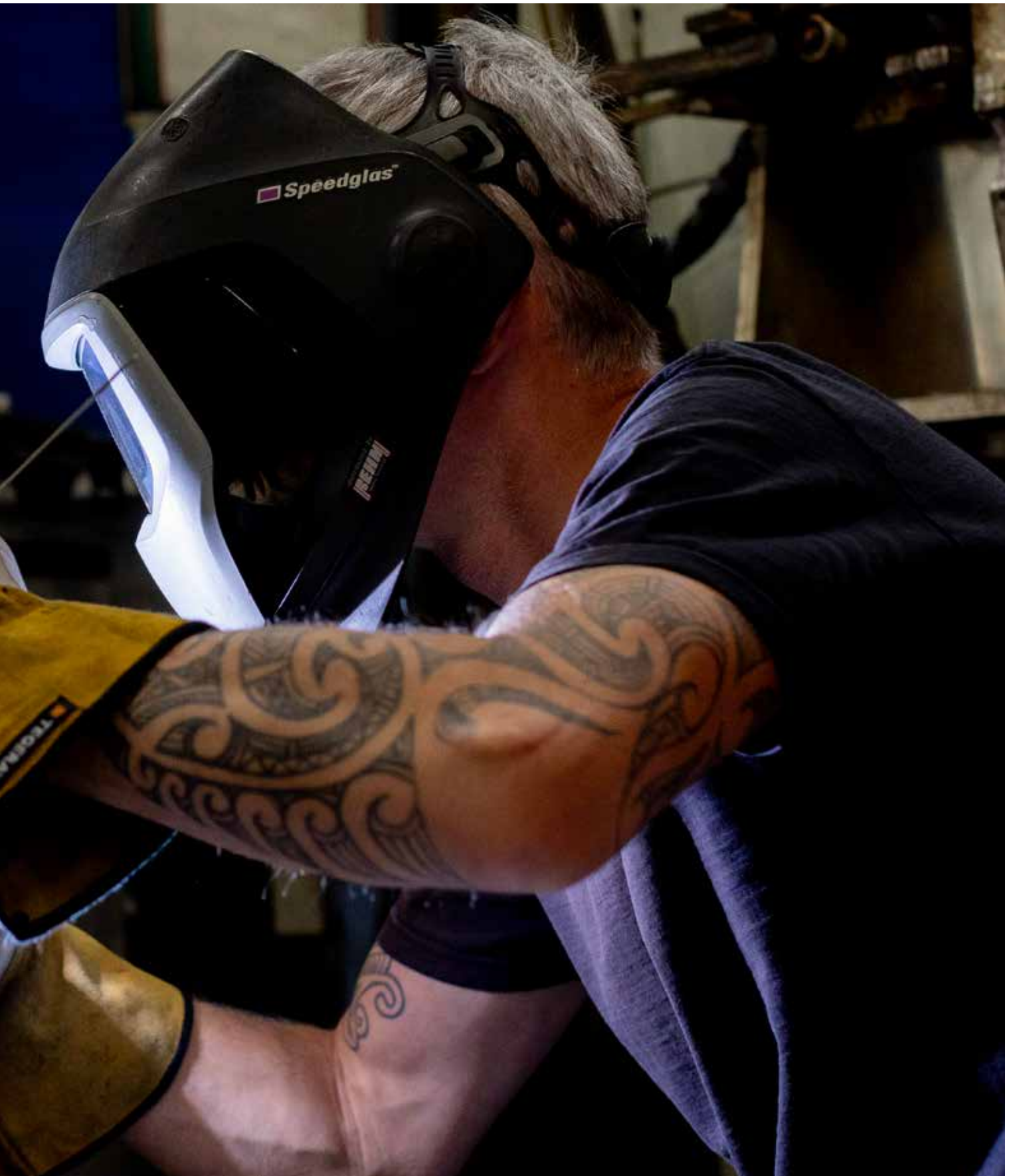

We adapt our tanks to your needs

Every use is different. And we at Speidel encourage this diversity: you can actually order your customised tank as if it were a tailor-made suit. Feel free to ask!





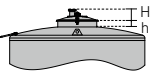
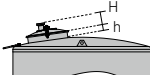
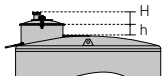

Ventilation

ACCESSORIES VENTILATION (WELD-ON PIECES)

Item	Tank- \varnothing mm	Material	Order No. loose	Order No. mounted
For dome lid · BD, FD				
	Stainless steel vent connection AGG 1 1/2" (BSP) in lid with sealing cap · Instead of drilled hole \varnothing 38 mm with plastic blank cap			
	440–820	AISI 304	-	OB-041D
Instead of filling and vent connection external thread NW 50 Rd 78 x 1/6" · FS-MO, AS-MO, MS-MO, RS-MO, RA-MO				
	Filling and vent connection			
	1 External thread NW 65 Rd 95 x 1/6"	820–3,600	AISI 316	- ES-080H
	2 External thread 40 Macon	820–3,600	AISI 316	- ES-080D
	3 Additional external thread 70 Macon	820–3,600	AISI 316	- ES-080C
	4 Clamp 2"	820–3,600	AISI 316	- ES-080L
Dome "pressureless"				
	Filler neck located in the centre of the tank top · Tank top without moulded channel · Flap lid with NW 50, external thread Rd 78 x 1/6"			
	1 NW 400, h = 65 mm, H = approx. 195 mm	820–3,600	AISI 316	- OB-040L
	2 NW 400, h = 200 mm, H = approx. 330 mm	820–3,600	AISI 316	- OB-040R
	3 NW 600, h = 100 mm, H = approx. 230 mm	1,000–3,600	AISI 316	- OB-040Z
	4 NW 600, h = 200 mm, H = approx. 330 mm	1,000–3,600	AISI 316	- OB-041F
	5 NW 800, h = 105 mm, H = approx. 160 mm (with filler neck protection)	1,400–3,600	AISI 316	- OB-041A
	6 NW 1,000, h = 200 mm, H = approx. 300 mm (with filler neck protection)	1,600–3,600	AISI 316	- OB-041H
	Filler neck located in the tank top in a forward position · Tank top without moulded channel without complete deaeration · Flap lid with NW 50, external thread Rd 78 x 1/6"			
	1 NW 200, h = 85 mm, H = approx. 185 mm	1,000–1,400	AISI 316	- OB-040X
	2 NW 400, h = 65 mm, H = approx. 165 mm	1,000–3,600	AISI 316	- OB-040F
	3 NW 600, h = 100 mm, H = approx. 230 mm	1,000–3,600	AISI 316	- OB-040Y
	Filler neck located in the tank top in a forward upright position · Tank top with moulded channel for complete deaeration · Flap lid with NW 50, external thread Rd 78 x 1/6"			
	1 NW 200, h = approx. 150 mm, H = approx. 270 mm	1,000–2,000 Rectangular tanks	AISI 316	- OB-041B
	2 NW 400, h = approx. 150 mm, H = approx. 270 mm	do.	AISI 316	- OB-0400
	3 NW 600, h = approx. 150 mm, H = approx. 270 mm	1,400–2,000 Rectangular tanks	AISI 316	- OB-041C

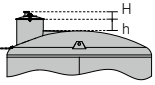
Pay attention to sufficient space / height for the opening and handling of the domes.

ACCESSORIES VENTILATION (WELD-ON PIECES)

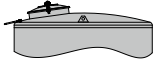

Item	Tank- \varnothing mm	Material	Order No.	
			loose	mounted
 <p>Filler neck located in the tank top in a forward upright position, with vent channel</p> <ul style="list-style-type: none"> · Tank top with welded-on vent · Flap lid with NW 50, external thread Rd 78 x 1/6" NW 400, h = approx. 200 mm, H = approx. 320 mm 	2,200–3,600	AISI 316	-	OB-040T
 <p>Filler neck in flap lid instead of NW 50 Rd 78 x 1/6"</p> <ul style="list-style-type: none"> 1 Connection external thread 40 Macon 2 Clamp 2" 	820–3,600 820–3,600	AISI 316 AISI 316	- -	ES-080D ES-080L
 <p>Vent outlet</p> <ul style="list-style-type: none"> · With filling and vent connection NW 50 Rd 78 x 1/6" 	2,200–3,600	AISI 316	-	OB-040U
 <p>Drain outlet</p> <ul style="list-style-type: none"> · With drain outlet elbow NW 50 DIN 11851 	2,200–3,600	AISI 304	-	RA-151H
 <p>Ventilation hood</p> <ul style="list-style-type: none"> · For ventilation for large volumes · With air redirection and fly screen · For pressureless application 1 NW 200 2 NW 400 	820–3,600 820–3,600	AISI 304 AISI 304	- -	OB-043A OB-043B
Dome "Pressure"				
 <p>Filler neck located in the tank top in a forward position</p> <ul style="list-style-type: none"> · Tank top without moulded channel without complete deaeration · With flap lid · NW 400, h = 65 mm, H = approx. 165 mm 1 Pressure stability 1,0 bar 2 Pressure stability 3,0 bar 	1,000–3,600 1,000–3,600	AISI 316 AISI 316	- -	OB-042A OB-042B



ACCESSORIES VENTILATION (SCREW-ON AND SPARE PARTS)

	Item	Tank- \emptyset mm	Material	Order No.	
				loose	mounted
	For dome lid · BD, FD				
	Complete replacement lid · New version with inner bracket closing · With drilled hole \emptyset 38 mm and plastic blank cap to hold the fermentation lock with bung	440-820	-	75555	-
	For lid UF				
	Lid without venting screw connection, clamping ring and ball knob 1 \emptyset 280 mm 2 \emptyset 350 mm 3 \emptyset 440 mm	- - -	- - -	95494 95495 95496	- - -
	Clamping ring for UF lid 1 \emptyset 280 mm 2 \emptyset 350 mm 3 \emptyset 440 mm	- - -	- - -	91856 76691 76692	- - -
	Fermentation lock with bung	440-820	plastic, rubber	21010	-
	To filling and vent connection external thread NW 50 Rd 78 x 1/6" · FS-M0, AS-M0, MS-M0, RS-M0, RA-M0				
	Fermentation tube with two compartments including bung, straight version 1 For tank capacity up to 10,000 liter 2 For tank capacity from 10,000 liter upwards	550-2.000 2.200-3.600	plastic, rubber	80430 84873	- -
	Fermentation tube with two compartments including bung, inclined version 1 For tank capacity up to 10,000 liter 2 For tank capacity from 10,000 liter upwards	820-2,000 2,200-3,600	acrylic/ rubber	70371 84874	- -
	Pressure compensating valve (spring-loaded) NW 50 DIN 11851	820-3,600	plastic	60911	-
	Feed hopper	820-3,600	plastic	46950	-

ACCESSORIES VENTILATION (SCREW-ON AND SPARE PARTS)







Item	Tank- \emptyset mm	Material	Order No.		
			loose	mounted	
To dome					
· BD, FD, UF, FS-MO, AS-MO, MS-MO, RS-MO, RA-MO					
Seals					
	1 Sealing for dome lid BD / FD: old version (for gluing in)*	-	-	60094	-
	2 Sealing for dome lid BD / FD: new version	-	-	74914	-
	3 For clamping ring lid UF \emptyset 280 mm	-	-	91859	-
	4 For clamping ring lid UF \emptyset 350 mm	-	-	76685	-
	5 For clamping ring lid UF \emptyset 440 mm	-	-	76686	-
	6 Sealing for filler neck NW200 (Mat. EPDM)	-	-	87850	-
	7 Sealing for filler neck NW400 (Mat. EPDM)	-	-	86386	-
	8 Sealing for filler neck NW600 (Mat. EPDM)	-	-	87976	-
	9 Sealing for filler neck NW200 (Mat. Silikon) - standard	-	-	87852	-
	10 Sealing for filler neck NW400 (Mat. Silikon) - standard	-	-	87750	-
	11 Sealing for filler neck NW600 (Mat. Silikon) - standard	-	-	87857	-
To open top tanks					
	Dust lid	440	AISI 304	95247	-
	· FO, BO, SO-Z, KO, RO-Z	550	AISI 304	92375	-
		630	AISI 304	70325	-
		820	AISI 304	70326	-
		1,000	AISI 304	70327	-
		1,200	AISI 304	70328	-
		1,400	AISI 304	68962	-
	Sack support				
	· SO-Z, RO-Z				
	1 For tank 530 liter	820	AISI 304	70319	-
	2 For tank 750 liter	1,000	AISI 304	70320	-
3 For tank 1,000 liter	1,200	AISI 304	70321	-	

* Adhesives can be found on page 185



Racking outlet and bottom outlet



ACCESSORIES RACKING OUTLET AND BOTTOM OUTLET (WELD-ON PIECES)

Item	Tank- \varnothing mm	Material	Order No. loose	Order No. mounted
To racking outlet drilled hole 48 mm · FO, FS-MO, AS-MO, MS-MO, RS-MO, RA-MO				
Weld-on gland with thread				
	1 NW 40 DIN 11851	630-820	AISI304	- KA-120C
	2 NW 50 DIN 11851	630-3.600	AISI304	- KA-120D
	3 NW 65 DIN 11851	820-3.600	AISI304	- KA-120L
	4 NW 80 DIN 11851	1.000-3.600	AISI304	- KA-121C
	5 NW 100 DIN 11851	1.000-3.600	AISI304	- KA-120X
	6 NW 125 DIN 11851	1.000-3.600	AISI304	- KA-120Y
	7 Clamp 1 1/2"	820-3.600	AISI304	- KA-120Z
	8 Clamp 2"	820-3.600	AISI304	- KA-121D
	9 Clamp 2 1/2"	820-3.600	AISI304	- KA-121E
	10 NW 50 with flange 100x100	820-3.600	AISI304	- KA-120E
	11 RJT 1 1/2"	820-3.600	AISI304	- KA-1210
	12 RJT 2"	820-3.600	AISI304	- KA-121P
	13 RJT 2 1/2"	820-3.600	AISI304	- KA-121Q
Instead of bottom outlet external thread NW 40 DIN 11851 · FO, FS-MO, AS-MO, MS-MO, RS-MO, RA-MO				
Weld-on bow with connection				
	1 NW 50 DIN 11851	630-820	AISI304	- RA-150B
	2 NW 65 DIN 11851	820	AISI304	- RA-150G
	3 NW 50 with flange 100x100	820	AISI304	- RA-150C
	4 Clamp 1 1/2"	630-820	AISI304	- RA-151B
	5 Clamp 2"	630-820	AISI304	- RA-151C
	6 RJT 1 1/2"	820-3.600	AISI304	- RA-1510
	7 RJT 2"	820-3.600	AISI304	- RA-151J
	8 RJT 2 1/2"	820-3.600	AISI304	- RA-151K
Instead of bottom outlet external thread · FO, FS-MO, AS-MO, MS-MO, RS-MO, RA-MO				
Anschweiß-Stutzen				
	1 NW 40 DIN 11851	820-3.600	AISI304	- RA-150A
	2 NW 65 DIN 11851	820-3.600	AISI304	- RA-150G
	3 NW 80 DIN 11851	1.000-3.600	AISI304	- RA-150X
	4 NW 100 DIN 11851	1.000-3.600	AISI304	- RA-150Y
	5 MG 90	1.000-3.600	AISI304	- RA-150Z
	6 NW 50 with flange 100x100	820-3.600	AISI304	- RA-150C
	7 Clamp 1 1/2"	820-3.600	AISI304	- RA-151B
	8 Clamp 2"	820-3.600	AISI304	- RA-151C
	9 Clamp 2 1/2"	820-3.600	AISI304	- RA-151D
	10 Macon 40	820-3.600	AISI304	- RA-151I
	11 RJT 1 1/2"	820-3.600	AISI304	- RA-151L
	12 RJT 2"	820-3.600	AISI304	- RA-151M
	13 RJT 2 1/2"	820-3.600	AISI304	- RA-151N
As racking outlet · FS-MO-1B, FS-MO-3B, FS-MO-3B-ZKG				
Racking outlet neck in tank bottom				
	1 With outlet NW 40 DIN 11851	630-3.000	AISI304	- KA-121I
	2 With outlet NW 50 DIN 11851	630-3.000	AISI304	- KA-121J
	3 With outlet Clamp 1 1/2"	630-3.000	AISI304	- KA-121K
	4 With outlet Clamp 2"	630-3.000	AISI304	- KA-121L
	Yeast plug inside bottom outlet neck			
	1 NW 40	630-3.000	AISI304	- HS-100-A

ACCESSORIES RACKING OUTLET AND BOTTOM OUTLET (SCREW-ON AND SPARE PARTS)

Item	Tank- \emptyset mm	Material	Order No. loose	Order No. mounted	
<u>Taps etc. G 3/4"</u> · BD, FD, B0, F0					
	Drain valve G 3/4" (BSP) with counter nut	350–550	AISI 304	65276	-
	Drain valve G 3/4" (BSP)	350–550	red brass chrome-plated	65079	-
	Ball valve AG / AG G 3/4" (BSP)	350–550	AISI 304	75104	-
	Drain valve G 3/4" (BSP)	350–550	plastic	21013	-
	Blank bung G 3/4" (not shown)	350–550	plastic	60068	-
<u>Taps etc. G 1"</u> · BD, FD, B0, F01					
	Sealing cap G 1" (BSP)	630–820	AISI 304	64938	-
	Drain valve with cap nut G 1" (BSP)	630–820	AISI 304	65277	-
	Ball valve AGG 1" (BSP)	630–820	AISI 304	64939	-
	Outlet elbow 90° with cap nut G 1" (BSP)	630–820	plastic	64852	-
	Transmission: IG 1" outgoing unit WKN	630–820	AISI 304	67832	-
	Transmission: IG 1" outgoing unit MZR	630–820	AISI 304	67833	-
<u>Taps etc. G 1 1/4"</u> · BD, FD, B0, F01					
	Ball valve outlet AG G 1 1/4" (BSP)	630–820	AISI 304	64940	-
	Ball valve outlet IG G 1 1/4" (BSP)	630–820	AISI 304	64941	-
	Sealing cap G 1 1/4" (BSP)	630–820	AISI 304	64960	-
<u>Taps etc. G 2 1/2"</u>					
	Sealing cap G 2 1/2" (BSP)	-	AISI 304	63921	-
	Ball valve NW 65 IG G 2 1/2" (BSP)	-	Ms-tin-coated	64944	-

ACCESSORIES RACKING OUTLET AND BOTTOM OUTLET (SCREW-ON AND SPARE PARTS)

Item	Tank- \emptyset mm	Material	Order No. loose	Order No. mounted	
To racking outlet thread and bottom outlet thread · FO, F02, FS-M0, AS-M0, MS-M0, RS-M0, RA-M0					
Sealing cap					
	1 NW 25 DIN 11851	630-3,000	AISI 304	76493	-
	2 NW 40 DIN 11851	630-3,000	AISI 304	62982	-
	3 NW 50 DIN 11851	1,000-3,000	AISI 304	62983	-
	4 NW 65 DIN 11851	1,000-3,000	AISI 304	65475	-
	5 Gr. 37 W 47 x 1/9"	-	AISI 304	63969	-
	6 Macon 40	-	AISI 304	68380	-
	7 G 1 1/4"	-	AISI 304	64960	-
	8 3/4"	630-3,000	AISI 304	64524	-
Disc valve NW 40 with security locking device and sealing caps with chain					
	1 Outlet NW 40 DIN 11851	630-820	AISI 304	61375	-
	2 Outlet WKN	630-820	AISI 304	61376	-
	3 Outlet Mzr. 32	630-820	AISI 304	61377	-
	4 Outlet Pfälzer 38	630-820	AISI 304	63008	-
Disc valve NW 50 with security locking device and sealing caps with chain					
	1 Outlet NW 40 DIN 11851	1,000-3,600	AISI 304	64948	-
	2 Outlet NW 50 DIN 11851	1,000-3,600	AISI 304	64945	-
	3 Outlet WKN	1,000-3,600	AISI 304	64946	-
	4 Outlet Mzr. 32	1,000-3,600	AISI 304	63109	-
	5 Outlet Pfälzer 38	1,000-3,600	AISI 304	64947	-
Disc valve with security locking device and sealing caps with chain					
	1 NW 25 DIN 11851	630-3,600	AISI 304	66417	-
	2 NW 32 DIN 11851	630-3,600	AISI 304	66418	-
	3 NW 65 DIN 11851	630-3,600	AISI 304	66235	-
	4 NW 80 DIN 11851	1,000-3,600	AISI 304	72747	-
	5 RJT 1 1/2"	1,000-3,600	AISI 304	84908	-
	6 RJT 2"	1,000-3,600	AISI 304	84909	-
Disc valve clamp with end-position locking and stainless steel pincer grip					
	1 Clamp 1 1/2"	550-3,600	AISI 304	79567	-
	2 Clamp 2"	550-3,600	AISI 304	79568	-
	3 Clamp 2 1/2"	550-3,600	AISI 304	79569	-
Disc valve					
	· FD, pressure tanks · IG-AG 1", V2A	550-820	AISI 304	87882	-
Bevel seat valve with sealing cap and chain					
	1 NW 40 DIN 11851	1,000-1,600	AISI 304	81606	-
	2 NW 50 DIN 11851	1,000-1,600	AISI 304	80738	-

ACCESSORIES RACKING OUTLET AND BOTTOM OUTLET (SCREW-ON AND SPARE PARTS)

**Item****Tank-ø**
mm**Material****Order No.**
loose**Order No.**
mounted**Ball valves with sealing cap with chain**

· Cap nut on tank side / outlet AG

1 NW 25 DIN 11851	-	AISI 304	66420	-
2 NW 32 DIN 11851	-	AISI 304	66421	-
3 NW 40 DIN 11851	-	AISI 304	65797	-
4 NW 50 DIN 11851	-	AISI 304	65158	-
5 NW 65 DIN 11851	-	AISI 304	65159	-
6 NW 80 DIN 11851	-	AISI 304	66413	-
7 NW 100 DIN 11851	-	AISI 304	66414	-
8 NW 125 DIN 11851	-	AISI 304	65684	-
9 MG 90	-	AISI 304	65539	-
10 Clamp 1 1/2"	-	AISI 304	79571	-
11 Clamp 2"	-	AISI 304	79572	-
12 Clamp 2 1/2"	-	AISI 304	79573	-
13 RJT 1 1/2"	-	AISI 304	84914	-
14 RJT 2"	-	AISI 304	84915	-

To bottom outlet

· FS-MO-3B-ZKG

**Racking and bottom outlet valve**

· Tank sided connection to cone

· Outlets including bow 90 for racking and bottom outlet connection (plus disc valve)

- 1 Tank sided NW 100 DIN 11851,
Outlets NW 25 DIN 11851
- 2 Tank sided NW 100 DIN 11851,
Outlets NW 40 DIN 11851

**Available from 1,000 liter +only
possible with height adjustments**

AISI 304	92818	-
AISI 304	91999	-







Sampling

ACCESSORIES SAMPLING (WELD-ON PIECES)

Item	Tank-ø	Material	Order No.	Order No.
	mm		loose	mounted
To sampling · FO, F01, F02, AS-MO, MS-MO, RS-MO, RA-MO				
	Weld-on thread			
	1 NW 10 DIN 11851	630-2,000	AISI304	- PE -100A
	2 NW 20 DIN 11851	630-2,000	AISI304	- PE -100E

ACCESSORIES SAMPLING (SCREW-ON AND SPARE PARTS)



Item	Tank-ø	Material	Order No.	Order No.
	mm		loose	mounted
To sampling · FO, F01, F02, FS-MO, AS-MO				
	Sampling tap with cap nut			
	1 NW 10 DIN 11851	630-2,000	AISI304	64949 -
	2 NW 20 DIN 11851	630-2,000	AISI304	65583 -
Sealing kit				
	1 For sampling tap NW 10 / 1/2"	-	-	45506 -
	2 For sampling tap NW 20	-	-	84712 -
	Sampling tap with cap nut			
	NW 10 DIN 11851 · Flame resistant · With connection thread for knuckle spiral			
	630-3,000	AISI304	83922	-
	VA Knuckle spiral, connection 3/8"			
	· For froth-less sampling · Flame resistant			83866
To sampling				
· KZE-/ KZEK-tank, FS-MO-8B				
	Sampling tap with cap nut			
	NW 20 DIN 11851	1,000-1,600	AISI304	79362 -

Fill level indication

ACCESSORIES FILL LEVEL INDICATION (WELD-ON PIECES)

Item	Tank-ø	Material	Order No.	Order No.
	mm		loose	mounted
 To fill level · FO, F02 <hr/> Weld-on thread NW 10 DIN 11851				
	630–2.000	AISI 304	-	FS-130A

ACCESSORIES FILL LEVEL INDICATION (SCREW-ON AND SPARE PARTS)

Item	Tank-ø	Material	Order No.	Order No.
	mm		loose	mounted
To fill level · FO, F01, F02 <hr/>  Fill level indicator NW 10 · Weld-on thread NW 10 and fastening points · Sight glass valve NW 10 DIN 11851 · Acrylic glass clear-view pipe NW 10 · Stainless steel protection strip with liter scale				
1 Up to 999 liter tank capacity	550– 820	AISI 304	-	FS -130G
2 Up to 4,999 liter tank capacity	1,000–2,000	AISI 304	-	FS -130H
3 Up to 10,000 liter tank capacity	1,600–2,000	AISI 304	-	FS -130I
4 Up to 15,200 liter tank capacity	1,800–2,000	AISI 304	-	FS -130K
5 Up to 999 liter tank capacity	550– 820	AISI 304	FSA*	-
6 Up to 4,999 liter tank capacity	1,000–2,000	AISI 304	FSA*	-
7 Up to 10,000 liter tank capacity	1,600–2,000	AISI 304	FSA*	-
8 Up to 15,200 liter tank capacity	1,800–2,000	AISI 304	FSA*	-
* When ordering a fill level indicator "loose" please also mention the type of tank and the tank's capacity along with the order no.				
 Fill level indicator NW 20 · Weld-on thread NW 20 and fastening points · Sight glass valve NW 20 DIN 11851 · Acrylic glass clear-view pipe NW 20 · Stainless steel protection strip with liter scale				
1 Up to 4,999 liter tank capacity	1,000–1,800	AISI 304	-	FS -130R
2 Up to 10,000 liter tank capacity	1,600–2,000	AISI 304	-	FS -130W
3 Up to 20,000 liter tank capacity	1,800–2,000	AISI 304	-	FS -130X
Sealing kit for sight glass valve				
1 NW 10 / 1/2"	-	-	45504	-
2 NW 20	-	-	84713	-
Sight glass valve				
1 NW 10	-	-	64065	-
2 1/2"	-	-	63190	-
Discharge nut für sight glass valve				
	-	-	81614	-

ACCESSORIES FILL LEVEL INDICATION (SCREW-ON AND SPARE PARTS)

Item	Tank- \emptyset mm	Material	Order No.	
			loose	mounted

To fill level

- FS-MO, AS-MO, MS-MO, RS-MO, RA-MO, RS-MO-Q, RA-MO-Q

**Fill level indicator NW 10**

- Weld-on thread NW 10 and fastening points
- Sight glass valve NW 10 DIN 11851
- Acrylic glass clear-view pipe NW 10
- Stainless steel protection strip with liter scale

1 Up to	999 liter tank capacity	820–1,000	AISI 304	FSA*	FS -130G
2 Up to	4,999 liter tank capacity	820–2,000	AISI 304	FSA*	FS -130H
3 Up to	10,000 liter tank capacity	1,400–1,600	AISI 304	FSA*	FS -130I
4 Up to	20,000 liter tank capacity	1,800–3,600	AISI 304	FSA*	FS -130K
5 Up to	50,000 liter tank capacity	2,000–3,600	AISI 304	FSA*	FS -130P
6 Up to	100,000 liter tank capacity	2,000–3,600	AISI 304	FSA*	FS -131Z

- * When ordering a fill level indicator "loose" please also mention the type of tank and the tank's capacity along with the order no.

**Fill level indicator NW 20**

- Weld-on thread NW 20 and fastening points
- Sight glass valve NW 20 DIN 11851
- Acrylic glass clear-view pipe NW 20
- Stainless steel protection strip with liter scale

1 Up to	999 liter tank capacity	820–1,000	AISI 304	-	FS -130S
2 Up to	4,999 liter tank capacity	820–2,000	AISI 304	-	FS -130R
3 Up to	10,000 liter tank capacity	1,400–2,600	AISI 304	-	FS -130W
4 Up to	20,000 liter tank capacity	1,800–3,600	AISI 304	-	FS -130X
5 Up to	50,000 liter tank capacity	2,000–3,600	AISI 304	-	FS -130U
6 Up to	100,000 liter tank capacity	2,000–3,600	AISI 304	-	FS -130Z

Fill level indicator NW 20

- Calibratable with millimeter scale and type plate

1 Up to	999 liter tank capacity	820–1,000	AISI 304	-	FS -130L
2 Up to	4,999 liter tank capacity	820–2,000	AISI 304	-	FS -130M
3 Up to	10,000 liter tank capacity	1,400–2,600	AISI 304	-	FS -130N
4 Up to	20,000 liter tank capacity	1,800–3,600	AISI 304	-	FS -130O
5 Up to	33,000 liter tank capacity	2,000–3,600	AISI 304	-	FS -130Q

- * Please note the information on additional costs for tanks with calibrated level indicator on page 193.

Macrolon tube for fill level indicator**NW 10 (surcharge)**

1 Up to	999 liter tank capacity	820–1,000	macrolon	-	MCR -101
2 Up to	4,999 liter tank capacity	820–2,000	macrolon	-	MCR -102
3 Up to	10,000 liter tank capacity	1,400–2,000	macrolon	-	MCR -103

Genuine glass pipe for fill level indicator**NW 20 (surcharge)**

2 Up to	4,999 liter tank capacity	820–1,400	glass	-	EGR -202
---------	---------------------------	-----------	-------	---	----------

To fill level

- FS-MO-1B, FS-MO-3B, FS-MO-3B-ZKG

Fill level indicator NW 10

- With liter scale
- Closed version

1 Up to	999 liter tank capacity	630–1,000	AISI 304	-	FS -130G
2 Up to	4,999 liter tank capacity	1,000–1,400	AISI 304	-	FS -130H
3 Up to	10,000 liter tank capacity	1,900–2,600	AISI 304	-	FS -130I
4 Up to	20,000 liter tank capacity	2,000–3,000	AISI 304	-	FS -130K
5 Up to	50,000 liter tank capacity	2,200–3,000	AISI 304	-	FS -130P

ACCESSORIES FILL LEVEL INDICATION (SCREW-ON AND SPARE PARTS)

Item	Tank- \emptyset mm	Material	Order No. loose	Order No. mounted
To fill level · FS-MO-8B				
Fill level indicator NW10 · With liter scale with pressure-resistant fabric tube · Geschlossene Version				
1 Up to 4,999 liter tank capacity	1,000-1,400	AISI 304	-	FS -131H
3 Up to 10,000 liter tank capacity	1,600	AISI 304	-	FS -131I



Temperature measurement

ACCESSORIES TEMPERATURE MEASUREMENT (WELD-ON PIECES)

For local temperature regulation

· F0, FS-MO, AS-MO, MS-MO, RS-MO, RA-MO, RS-MO-Q, RA-MO-Q



Positioning

T1 = Front left, beside level indicator (not for 900x1.400 mm and 1.100x1.600 mm)

T2 = In a central position at the back

T3 = At the back 45° left

T4 = Long side front left (only RS-MO/RA-MO, only for connection position C1–C4)

T5 = Long side at the back right (only RS-MO/RA-MO, only for connection position C5–C8)

T6 = Front right beside level indicator, level indicator offset to the left (not for 900x1,400 mm and 1,100x1,600 mm)

T7 = Front right beside level indicator, level indicator at standard position

Height always according to position standard temperature measurement



Item	Tank-ø mm	Material	Order No. mounted
Possible choices			
T1 = Weld-on gland NW 10 DIN 11851		AISI 304	TS1A
T1 = Drilled hole ø 13 mm		AISI 304	TS1B
T1 = Drilled hole ø 18 mm	820–2,000	AISI 304	TS1C
T1 = Weld-on gland NW 20 DIN 11851	+ Rectangular tanks	AISI 304	TS1D
T2 = Weld-on gland NW 10 DIN 11851		AISI 304	TS2A
T2 = Drilled hole ø 13 mm	820–2,000	AISI 304	TS2B
T2 = Drilled hole ø 18 mm	+ Rectangular tanks	AISI 304	TS2C
T3 = Weld-on gland NW 10 DIN 11851		AISI 304	TS3A
T3 = Drilled hole ø 13 mm		AISI 304	TS3B
T3 = Drilled hole ø 18 mm	820–2,000	AISI 304	TS3C
T4 = Weld-on gland NW 10 DIN 11851		AISI 304	TS4A
T4 = Drilled hole ø 13 mm		AISI 304	TS4B
T4 = Drilled hole ø 18 mm	Rectangular tanks	AISI 304	TS4C
T5 = Weld-on gland NW 10 DIN 11851		AISI 304	TS5A
T5 = Drilled hole ø 13 mm		AISI 304	TS5B
T5 = Drilled hole ø 18 mm	Rectangular tanks	AISI 304	TS5C
T6 = Weld-on gland NW 10 DIN 11851		AISI 304	TS6A
T6 = Drilled hole ø 13 mm		AISI 304	TS6B
T6 = Drilled hole ø 18 mm	1.000–2,000	AISI 304	TS6C
T6 = Weld-on gland NW 20 DIN 11851	+ Rectangular tanks	AISI 304	TS6D
T7 = Weld-on gland NW 10 DIN 11851		AISI 304	TS7A
T7 = Drilled hole ø 13 mm		AISI 304	TS7B
T7 = Drilled hole ø 18 mm	820–2,000	AISI 304	TS7C
T7 = Weld-on gland NW 20 DIN 11851	+ Rectangular tanks	AISI 304	TS7D

Due to technical reasons the position of the connection can differ in some cases.

ZUBEHÖR TEMPERATURMESSUNG (ANSCHWEISSTEILE)



Item	Tank- \emptyset mm	Material	Order No.	Order No.	
			loose	mounted	
To temperature measurement · FS-MO, AS-MO, MS-MO					
	Bi-metal dial thermometer 100 mm \emptyset · Measuring range -20 °C to +60 °C · Weld-on thread NW 10 DIN 11851				
	1 Incl. threaded sleeve, L = 125 mm	820–3,600	AISI 304	-	TM-140C
	2 Incl. threaded sleeve, L = 250 mm	820–3,600	AISI 304	-	TM-140D
Bi-metal dial thermometer 100 mm \emptyset · Measuring range in °C and °Fahrenheit · Weld-on thread NW 10 DIN 11851 · Incl. threaded sleeve, L = 125 mm					
	820–3,600	AISI 304	-	TM-140E	
To temperature measurement · FS-MO-1B, FS-MO-3B, FS-MO-8B					
Bi-metal dial thermometer 100 mm \emptyset · Measuring range -20 °C to +60 °C · Incl. threaded sleeve to thermometer · Adapter					
	630–3,000	AISI 304	-	TM-140F	
	630–3,000	AISI 304	-	84379	

ACCESSORIES TEMPERATURE MEASUREMENT (SCREW-ON AND SPARE PARTS)

Item	Tank- \emptyset mm	Material	Order No.	Order No.	
			loose	mounted	
To temperature measurement · FO, FS-MO, AS-MO					
	Bi-metal dial thermometer 100 mm \emptyset · Measuring range -20 °C to +60 °C				
	1 For threaded sleeve, L = 125 mm	820–3,600	AISI 304	63887	-
	2 For threaded sleeve, L = 250 mm	820–3,600	AISI 304	83975	-
Bi-metal dial thermometer 100 mm \emptyset · Measuring range in °C and °Fahrenheit · For threaded sleeve, L = 125 mm					
	820–3,600	AISI 304	73558	-	
	Threaded sleeve to thermometer				
	1 L = 125 mm	820–3,600	AISI 304	64071	-
	2 L = 250 mm	820–3,600	AISI 304	83976	-
· FD-1.2B, FD-2.5B, ZKG-1.2B, ZKG-2.5B					
	"Chilly" wort chiller LT 2.2 kW · Temperature -10 °C to +25 °C · Hose connector set to fermentation tank 240 liter / 525 liter / 625 liter / pressure tanks · Further "Chilly" cooling units available on request				
		-	-	77498	-

Manhole

ACCESSORIES MANHOLE (WELD-ON PIECES)

Item	Tank- \emptyset mm	Material	Order No. loose	Order No. mounted
To manhole · FO, KO, ST-T				
 Manhole · Seamlessly moulded out of tank shell 420x320 mm LW · Door with food-safe sealing, gapless and vulcanised, butterfly bow and hand wheel	820-3,000	AISI 304	-	ML-110A
 Swivelling handle for manhole · 420x320 mm LW	820-3,000	-	-	ML-110N





ACCESSORIES MANHOLE (SCREW-ON AND SPARE PARTS)

Item	Tank- \emptyset mm	Material	Order No. loose	Order No. mounted
Sealings · BD, FD, FS-MO, AS-MO, MS-MO, RS-MO, RA-MO				
 Sealing for slipping over manhole 1 420x320 mm 2 320x250 mm 3 340x440 mm	820-3,600 820 1,000-3,600	- - -	79028 81485 81353	- - -
Sealing for glueing into manhole 1 420x320 mm 2 320x250 mm	820-2,000 820	- -	60786 62593	- -
Glue Terokal 58 gr.	-	-	65389	-



Legs

ACCESSORIES LEGS (WELD-ON PIECES)

	Item	Tank- \emptyset mm	Material	Order No.	Order No.
				loose	mounted
	Tank legs				
	· FO, FS-MO, MS-MO				
	1 Short version standard -100 mm	820-2,000	-	-	FA -030B
	2 Long version standard +92 mm	820	-	-	FA -030C
	3 Long version standard +219 mm	1,000	-	-	FA -030C
	4 Long version standard +176 mm	1,200	-	-	FA -030C
	5 Long version standard +168 mm	1,400	-	-	FA -030C
	6 Long version standard +138 mm	1,600	-	-	FA -030C
	7 Long version standard +136 mm	1,800	-	-	FA -030C
	8 Long version standard +96 mm	2,000	-	-	FA -030C
	9 Short version standard -100 mm	2,200-3,000	-	-	FA -030B
	10 Long version standard +100 mm	2,200-3,000	-	-	FA -030C
	Tank legs				
	· RS-MO				
	1 Short version standard - 100 mm	900x1,400	-	-	FA -030B
	2 Long version standard + 156 mm	-1,500x2,000	-	-	FA -030C
	3 Long version standard + 156 mm	900x1,400	-	-	FA -030C
	4 Long version standard + 156 mm	1,100x1,600	-	-	FA -030C
	5 Long version standard + 107 mm	1,300x1,800	-	-	FA -030C
	5 Long version standard + 107 mm	1,500x2,000	-	-	FA -030C
	Tank legs				
	· RS-MO-Q				
	1 Short version standard - 100 mm	1,400x1,400	-	-	FA -030B
	2 Long version standard + 156 mm	1,400x1,400	-	-	FA -030C
	Special leg lengths available on request in increments of approx. 100 mm				
	Foot strap for on-site dowelling	-	AISI 304	-	-
	PE-base for transportation and storage	820	PE	66186	FA -030E
		1,000	PE	66187	FA -030E
		1,200	PE	66188	FA -030E
	Transportation base on rolls				
	1 For FD 60-120 liter				
	· Heightening H=+ approx. 155 mm	-	PE	77520	-
	2 For FD 240 liter				
	· Heightening H=+ approx. 160 mm	-	PE	77400	-
	Storage rack for tanks with flat bottom				
	· BO, UF, BD				
		440	AISI304	97177	-
		550	AISI304	97186	-
		630	AISI304	96396	-
		820	AISI304	97196	-
		1,000	AISI304	97197	-
		1,200	AISI304	97205	-



ACCESSORIES LEGS (SCREW-ON AND SPARE PARTS)



Item	Tank- \emptyset mm	Material	Order No. loose	Order No. mounted
Height adjustment for tank legs				
· FO, FD-ZKG, FS-MO, MS-MO, FD-1.2B, FD-2.5B, ZKG-1.2B, ZKG-2.5B				
Height adjustments for tank legs				
· Levelling range of adjustable feet for tank legs				
· M20 min. 55 mm–max. 100 mm				
· M24 min. 60 mm–max. 130 mm				
· M30 min. 80 mm–max. 170 mm (welded to foot plate)				
· M36 min. 90 mm–max. 210 mm (welded to foot plate)				
1 Set= 3 pieces per tank M20	1,000–1,200	-	46127	-
2 Set= 6 pieces per tank M20	1,400–1,600	-	46125	-
3 Set= 6 pieces per tank M24	1,800–2,000	-	46128	-
4 Set= 8 pieces per tank M24	2,200–2,800	-	46129	-
5 Set= 8 pieces per tank M30	2,800–3,200	-	-	FA- 040A
6 Set= 10 pieces per tank M30	2,600–3,600	-	-	FA- 040B
7 Set= 12 pieces per tank M30	3,200–3,600	-	-	FA- 040C
8 Set= 14 pieces per tank M30	3,200–3,600	-	-	FA- 040D
9 Set= 16 pieces per tank M30	3,600	-	-	FA- 040E
10 Set= 10 pieces per tank M36	3,200	-	-	FA- 040F
11 Set= 12 pieces per tank M36	3,200–3,600	-	-	FA- 040G
12 Set= 14 pieces per tank M36	3,600	-	-	FA- 040H
13 Set= 16 pieces per tank M36	3,600	-	-	FA- 040I
Height adjustment for tank legs				
· RS-MO				
1 Set= 4 pieces per tank M20	-	-	46126	-
Height adjustment for tank legs				
· FS-MO-ZKG				
1 Set= 3 pieces per tank M20	630–1,200	-	46127	-
2 Set= 4 pieces per tank M20	1,400–1,800	-	46126	-
3 Set= 4 pieces per tank M24	1,600–2,200	-	46142	-
Height adjustment for tank legs				
· FS-MO-1B, FS-MO-3B, FS-MO-8B				
1 Set= 3 pieces per tank M20	630–1,200	-	46127	-
2 Set= 6 pieces per tank M20	1,400–1,600	-	46125	-
3 Set= 6 pieces per tank M24	1,800–2,000	-	46128	-
4 Set= 8 pieces per tank M24	2,200–2,800	-	46129	-
5 Set= 8 pieces per tank M30	2,600–3,000	-	-	FA- 040A
6 Set= 10 pieces per tank M30	2,600–3,000	-	-	FA- 040B
Height adjustment for tank legs				
· KZE-/KZEK-tank				
1 Set= 8 pieces per tank M20	1,600–1,800	-	46131	-
2 Set= 8 pieces per tank M24	2,000–2,800	-	46129	-
3 Set= 10 pieces per tank M24	2,400–2,600	-	46132	-
4 Set= 8 pieces per tank M30	2,800–3,200	-	-	FA- 040A
5 Set= 10 pieces per tank M30	2,600–3,600	-	-	FA- 040B
6 Set= 12 pieces per tank M30	3,200–3,600	-	-	FA- 040C
7 Set= 10 pieces per tank M36	3,200	-	-	FA- 040F
8 Set= 12 pieces per tank M36	3,200–3,600	-	-	FA- 040G
9 Set= 14 pieces per tank M36	3,400–3,600	-	-	FA- 040H
10 Set= 16 pieces per tank M36	3,600	-	-	FA -040I
11 Set= 18 pieces per tank M36	3,600	-	-	FA- 040J
12 Set= 20 pieces per tank M36	3,600	-	-	FA- 040K

Pipes

ACCESSORIES PIPES (WELD-ON PIECES)





Item	Tank- \varnothing mm	Material	Order No.		
			loose	mounted	
To cleaning · FS-M0, AS-M0					
	Cleaning pipe				
	· Drawn off to operating height				
	· Cleaning spray head, perforation 360° with clip fastener				
	· Connection DIN 11851 at tank front side				
· H=+ approx, 150 mm					
Spray head NW 25					
· Flow rate at 1,0 bar ~ 11 m ³ /h					
· Flow rate at 2,5 bar ~ 17 m ³ /h					
Spray head DN 40					
· Flow rate at 1,0 bar ~ 11 m ³ /h					
· Flow rate at i 2,5 bar ~ 19 m ³ /h					
Spray head DN 50					
· Flow rate at 1,0 bar ~ 28 m ³ /h					
· Flow rate at 2,5 bar ~ 42 m ³ /h					
1 DN 25 to	10,000 liter tank capacity	1,000–2,000	AISI 304	-	RL-025A
2 DN 40 to	10,000 liter tank capacity	1,000–2,400	AISI 304	-	RL-040A
3 DN 40 to	20,000 liter tank capacity	1,800–2,400	AISI 304	-	RL-040B
4 DN 40 to	30,000 liter tank capacity	2,200–2,400	AISI 304	-	RL-040C
5 DN 50 to	10,000 liter tank capacity	1,000–3,600	AISI 304	-	RL-050A
6 DN 50 to	20,000 liter tank capacity	1,800–3,200	AISI 304	-	RL-050B
7 DN 50 to	50,000 liter tank capacity	2,200–3,600	AISI 304	-	RL-050C
8 DN 50 to	125,000 liter tank capacity	3,000–3,600	AISI 304	-	RL-050D
Spray head, detachable from outside					
1 NW 40		1,000–3,600	AISI 304	-	RL-041A
2 NW 50		1,000–3,600	AISI 304	-	RL-051A
Connection from cleaning pipe to fill level indicator					
· H=+ approx. 50 mm		1,000–3,600	AISI 304	-	VL-050A
Connection from cleaning pipe to filler neck with spray head NW 20					
· H=+ approx. 50 mm		1,000–3,600	AISI 304	-	VL-050B
To cleaning · FD-1.2B, ZKG-1.2B, FD-2.5B, ZKG-2.5B					
	Spray head with spray head holder				
	· Spray head NW 10 for tank connection				
	NW 25 at tank top				
	1 Connection G 1"		AISI 304	-	94180-01
2 Connection NW 25		AISI 304	-	94180-02	
To cleaning · BD, FD, FD-S					
	Dome lid NW 220 with spray head NW 10				
	1 Connection G 1"		AISI 304	-	86162
	2 Connection NW 25		AISI 304	-	84360

ACCESSORIES PIPES (WELD-ON PIECES)









Item	Tank- \emptyset mm	Material	Order No. loose	Order No. mounted
To filling				
· FS-MO, RS-MO				
Filling pipe NW 50				
· Drawn off to operating height				
· Connection NW50 DIN 11851				
· H = + approx. 150 mm				
1 Up to 10,000 liter tank capacity	1,000–2,600	AISI 304	-	BF -100A
2 Up to 20,000 liter tank capacity	1,600–3,200	AISI 304	-	BF -200B
3 Up to 50,000 liter tank capacity	2,200–3,600	AISI 304	-	BF -400D
4 Up to 125,000 liter tank capacity	3,000–3,600	AISI 304	-	BF -500E
To ventilation				
· KZE-/KZEK-tank				
Ventilation pipe NW 40				
· Drawn off to operating height				
· Connection NW40 DIN 11851				
1 Up to 10,000 liter tank capacity	1,600–2,600	AISI 304	-	KL -100A
2 Up to 20,000 liter tank capacity	1,600–3,200	AISI 304	-	KL -200A
3 Up to 50,000 liter tank capacity	2,200–3,600	AISI 304	-	KL -500A
4 Up to 125,000 liter tank capacity	3,000–3,600	AISI 304	-	KL -125B
To ventilation				
· FS-MO-8B				
Ventilation pipe NW 25				
· Drawn off to operating height				
· Connection NW 25 DIN 11851				
· H = + approx. 150 mm	1,000–1,600	AISI 304	-	EL -100A
To double jackets				
· FS-MO / AS-MO, RS-MO / RA-MO, RS-MO-Q / RA-MO-Q				
Double jacket piping				
· Each 1 supply line and 1 return line (without cap), pulled up at height tank top				
· 1–2 drainage options, with cap in the inlet and return pipe				
· Individual double jackets are connected in parallel with fixed piping in supply and return lines				
	1,000–3,600	AISI304	-	-
	900x1,400–1,500x2,000	AISI304	-	-
	1,400 x 1,400	AISI304	-	-



ACCESSORIES PIPES (SCREW-ON AND SPARE PARTS)

Item	Tank- \emptyset mm	Material	Order No. loose	Order No. mounted
Armature for ventilation pipe · KZE-/ KZEK-tank  KZE-armature with bevel seat gate valve NW 40 DIN 11851 · Left: block valve NW 10 DIN 11851 with sterile filter, filter case made of stainless steel · Right: block valve NW 10 DIN 11851 with manu-vacuum manometer, safety valve (operating pressure 0.5 bar)	1,600–3,600	AISI 304	-	KE -100A
KZE-armature with disc valve NW 40 DIN 11851 · Left: block valve NW 10 DIN 11851 with sterile filter, filter case made of stainless steel · Right: block valve NW 10 DIN 11851 with manu-vacuum manometer, safety valve (operating pressure 0.5 bar)	1,600–3,600	AISI 304	-	KE -100B
Adapter for fermentation glass	1,600–3,600	AISI 304	79779	-
Fermentation glass for KZE-armature	1,600–3,600	glass	79778	-
Retrofit kit to steam safety valve	1,600–3,600	AISI 304	82064	-
 Armature for ventilation pipe · FS-M0-8B <hr/> Sparkling wine armature with bevel seat gate valve NW 25 DIN 11851 · Left: block valve NW 10 DIN 11851 with manometer, incl. connection NW 20 with sealing cap for nitrogen supply · Right: safety valve (operating pressure 8.0 bar)	1,000–1,600	AISI 304	-	SA -100A
 Filling support · KZE-/ KZEK-tank <hr/> Level detector (tester) · Welded on tank top with connection sleeve G 1/2" · Wire drawn off to operating height and protected by stainless steel cable tube · With connection plug SV 70	1,600–3,600		-	BH -100A
 Alarm device <hr/> Audible signal transmitter for connection to filling support · With connection plug SV 70	1,600–3,600	plastic	97167	-

ACCESSORIES PIPES (SCREW-ON AND SPARE PARTS)

Item	Tank- \varnothing mm	Material	Order No. loose	Order No. mounted
 <p>Fittings for pressure-regulation for bunging apparatus · FD-1.2B, ZKG-1.2B, FD-2.5B, ZKG-2.5B, FS-MO-1B, FS-MO-3B, ZKG-3B</p>				
 <p>Pressure-regulation (Pico) up to 1.0 bar / 3.0 bar · For junction G 3/4" on cleaning pipe</p>	630–3,000	AISI 304	87712	-
 <p>Pressure-regulation (Kellerfee) up to 1.0 bar / 3.0 bar · For junction NW 25 DIN 11851 on cleaning pipe</p>	630–3,000	AISI 304	81457	-
 <p>Pressure-regulation (Vario) up to 1.0 bar / 3.0 bar · For junction NW 25 DIN 11851 on cleaning pipe</p>	630–3,000	AISI 304	83863	-
 <p>Pressure-regulation (Vario-Plus) up to 1.0 bar / 3.0 bar · For junction NW 25 DIN 11851 on cleaning pipe</p>	630–3,000	AISI 304	81493	-
 <p>Fittings for pressure-regulation for bunging apparatus · FD-1.2B, ZKG-1.2B, FD-2.5B, ZKG-2.5B</p>				
 <p>T-adapter piece · For CO₂-connection / shut-off tap and bunging apparatus · Lateral 2xAG 3/4" · At bottom NW 25 for the connection to the tank nozzle on tank top</p>	-	-	87711	
 <p>CO₂-shut-off tap · Fits on T-adapter piece or for gland G 3/4" e. g. on cleaning pipe · IG-AG 3/4"</p>	-	-	87986	





Stirring device connections, flanges and supplementary threads

STIRRING DEVICE CONNECTIONS / FLANGES / SUPPLEMENT CONNECTIONS (WELD-ON PIECES)

Item	Tank- \emptyset mm	Material	Order No. loose	Order No. mounted	
Stirring device connection slanted					
	Stirring device connection, slanted welding				
	1 NW 40	1,000–3,600	AISI 304	-	KA-121M
	2 NW 50	1,000–3,600	AISI 304	-	KA-121N
Instead of stirring device connection					
AG 37 W 47x1 / 9"					
· S0-Z, R0-Z					
Stirring device connection neck					
1 External thread NW 40 DIN 11851	820–1,200	AISI 304	-	RW-160B	
2 External thread NW 50 DIN 11851	820–1,200	AISI 304	-	RW-160C	
3 External thread 40 Macon	820–1,200	AISI 304	-	RW-160D	
4 Without stirring device connection neck	820–1,200	AISI 304	-	RW-160E	
To stirring device					
Stirring device flange on the side					
· For standard seal flange stirring device mounted on the side of the tank shell					
· For stirring angle 30°–45°, with reinforcement ring, flange and fastening bolts					
· Flange is inclined inwards to avoid air bubbles					
1 Flange-DN 65	1,000–3,600	AISI 304	-	FL -065A	
2 Flange-DN 80	1,000–3,600	AISI 304	-	FL -080A	
3 Flange-DN 100	1,000–3,600	AISI 304	-	FL -100A	
4 Flange-DN 150	1,600–3,600	AISI 304	-	FL -150A	
5 Flange-DN 200	1,600–3,600	AISI 304	-	FL -200A	
6 Flange-DN 250	1,600–3,600	AISI 304	-	FL -250A	
Stirring device flange at tank top					
· For standard stirring device vertical at tank top, for upright standing stirring device, with reinforcement ring and fastening bolts					
1 Flange-DN 150	1,600–3,600	AISI 304	-	FZ -150A	
2 Flange-DN 200	1,600–3,600	AISI 304	-	FZ -200A	
3 Flange-DN 250	1,600–3,600	AISI 304	-	FZ -250A	
Stirring device on request under specification of the necessary process data.					



STIRRING DEVICE CONNECTIONS / FLANGES / SUPPLEMENT CONNECTIONS (WELD-ON PIECES)



Item	Tank- \emptyset mm	Material	Order No.		
			loose	mounted	
Weld- on gland					
	Weld-on gland horizontally				
	· Weld on gland horizontally at tank shell (from NW40 upwards with reinforcement plate)				
	· DIN 11851 or Clamp DIN 32676 / DIN 11864				
	1 NW 10	820-3,600	AISI 304	-	SH -010A
	2 NW 20	820-3,600	AISI 304	-	SH -020A
	3 NW 25	820-3,600	AISI 304	-	SH -025A
	4 NW 32	820-3,600	AISI 304	-	SH -032A
	5 NW 40	820-3,600	AISI 304	-	SH -040A
	6 NW 50	820-3,600	AISI 304	-	SH -050A
	7 NW 65	820-3,600	AISI 304	-	SH -065A
	8 NW 80	820-3,600	AISI 304	-	SH -080A
	9 NW 100	1,000-3,600	AISI 304	-	SH -100A
10 NW 125	1,000-3,600	AISI 304	-	SH -125A	
11 NW 150	1,000-3,600	AISI 304	-	SH -150A	
	Weld-on gland vertically				
	· Weld-on gland vertically at the tank top or tank bottom				
	· DIN 11851 or Clamp DIN 32676 / DIN 11864				
	1 NW 20	820-3,600	AISI 304	-	SV -020A
	2 NW 25	820-3,600	AISI 304	-	SV -025A
	3 NW 32	820-3,600	AISI 304	-	SV -032A
	4 NW 40	820-3,600	AISI 304	-	SV -040A
	5 NW 50	820-3,600	AISI 304	-	SV -050A
	6 NW 65	820-3,600	AISI 304	-	SV -065A
	7 NW 80	820-3,600	AISI 304	-	SV -080A
	8 NW 100	1,000-3,600	AISI 304	-	SV -100A
9 NW 125	1,000-3,600	AISI 304	-	SV -125A	
10 NW 150	1,000-3,600	AISI 304	-	SV -150A	

ACCESSORIES DOUBLE JACKET (SCREW-ON AND SPARE PARTS)

Item	Tank- \emptyset mm	Material	Order No.		
			loose	mounted	
	Adapter nozzle				
	· For double jacket connection G1" male thread				
	· Adapter with connection G1" female thread				
	1 Outlet G1/2" AG	-	AISI304	93298	-
	2 Outlet G3/4" AG	-	AISI304	93300	-
	3 Outlet clamp DN25	-	AISI304	66702	-
	4 Outlet NPT	-	AISI304	83672	-
5 Gardena	-	AISI304	66685	-	
6 Outlet NW25 DIN 11851	-	AISI304	69496	-	

Control modes, automation, mash and juice extraction



CONTROL MODES, AUTOMATION, MASH AND JUICE EXTRACTION (WELD-ON PIECES)

Item	Order No. mounted
	
<p>Automatic temperature regulation with target indicator and actual indicator · FD-MBT</p>	
<p>Automatic temperature regulation with target indicator and actual indicator</p> <ul style="list-style-type: none"> · Mash heating: Desired start temperature for fermentation – insert target value “heating”. The heater switches off automatically if the target value is reached. · Mash cooling: In order to avoid exceeding the desired fermentation temperature insert target value “cooling”. The cooler is switched on automatically via a solenoid valve and cools down the mash till it reaches or maintains the desired fermentation temperature. · Version including solenoid valves · Connection to locally available warm water / cold water source 	DMS -1
<p>Crush rods · FD-MBT</p>	
	
<p>Crush rods</p> <ul style="list-style-type: none"> · Vertical crush rods, laterally welded on tank shell, for better mixing of the mash 1 Up to 10,000 liter tank capacity 2 Up to 20,000 liter tank capacity 3 Up to 30,000 liter tank capacity 	BS-100A BS-100B BS-100C
<p>Alarm device · KZE-/KZEK-tank</p>	
<p>Alarm device with visual and audible signal transmitter</p> <ul style="list-style-type: none"> · For connection to level detector · Alarm horn with warning light, movably mounted on a bracket 	88329



Insulation, tank approval, tank labelling, additional costs for modification

ACCESSORIES (MISCELLANEOUS)

Item	Tank- \emptyset mm	Material	Order No. loose	Order No. mounted
Insulation				
Neoprene sleeve				
 1 For UF fermentation and storage barrel 15 liter	-	-	94137	-
2 For UF fermentation and storage barrel 30 liter	-	-	94130	-
3 For UF fermentation and storage barrel 60 liter	-	-	94131	-
Seal welded insulation				
· Completely insulated tank				
· Insulation material mineral wool / armaflex				
· Casing with stainless steel sheet, AISI 304, marbled outside / IIIc				
· Lengthwise and crosswise seal welded joints	1,000–3,000	-	-	ISO -100A
Riveted / screwed insulation				
· Completely insulated tank				
· Insulation material mineral wool / armaflex				
· Casing with stainless steel sheet, AISI 304, marbled outside / IIIc				
· Riveted and screwed lengthwise and crosswise joints	1,000–3,000	-	-	ISO -200A
Tank labelling				
 Sticker for tank labelling	820–3,600	-	83978	-
Inspection costs ATEX				
· Incl. documentation per tank variant	-	-	00038	-
Inspection costs for calibratable level indicator				
· Incl. documentation	-	-	00039-01	-
· Costs for Office of Weights and Measures	-	-	00039-02	-
Tank approval				
· For pressure tanks in accordance with the guideline for pressure device 2014 / 68 / EU				
TÜV-test with documentation				
1 For each tank	1,000–3,000	-	TÜV-001	-
2 One only for each entire order	1,000–3,000	-	TÜV-002	-
Additional costs for modification				
In case of variations from the listed version (plus additional costs of the structural element)	350–820	-	00024	-
	1,000–3,000	-		-
	900×1,400–1,500×2,000	-		-
	1,400×1,400	-	00019	-

Fine print

All prices are non-binding dealer prices without VAT. Surcharges/discounts can be determined as required (e.g. due to raw material developments). Delivery ex works / ex warehouse carriage forward, delivery costs on request. In case of orders up to a net value of 25.00 Euro we charge a service fee of 4.00 Euro plus VAT.

Shipping may require a crate to prevent damages in transit.

This non-returnable packaging costs:

Tank capacity up to 999 liter: 5 % of the net list price + VAT.

Tank capacity from 1,000 liter upwards: 3 % of the net list price + VAT.

Subject to technical changes. Dimensions and capacities listed non-binding.

In case of sale are not known – please request them.

Dimensions and technical layout are subject to the conventional production tolerance.

It is necessary to follow the instruction manuals, particularly the intended use of the product, the spatial limits and other important instructions.

Layout and outfit in compliance with our high Speidel standards, see catalogue descriptions.

If not specified otherwise, our tanks are meant for the installation inside of a building (inside installation) and to be used for stainless steel resistant mediums with a density of 1,1 kg/dm³ and an operating temperature of +5 to +40°celsius.

We are certified to the guidelines for pressure devices 2014 / 68 / EU.

Machines in compliance with machinery guideline 2006 / 42 / EG.

We reserve the right to equivalent and professional adaptations.

Our General Terms and Conditions apply (to be viewed on our website www.speidel-behaeltes.de).

Industrial, local parameters or rules need to be considered and observed.



Sustainability



We have always seen sustainability and environmental compatibility as a natural part of our mission and responsibility towards our customers and the environment. This is evident in the containers we manufacture, in the supply chains, in the production process and in our handling of resources.



We therefore source most of our primary materials from Germany. This means reliable sources of supply and short delivery routes with the best quality.



We avoid unnecessary welds in the design of our containers and their equipment. For example, the man-hole, ever-full rim and outlet bead are formed seamlessly from the starting material. This makes them very precise, hygienic and also environmentally friendly. This is because every weld seam requires grinding, polishing or pickling.

Every avoidance of a weld seam is therefore a sign of quality and in combination with our smooth surfaces, which can be cleaned almost without chemicals, this is a real contribution to the protection of our environment.

We cover 25 % of our electricity requirements from our own generation. With our photovoltaic system, we produce a total of 670,000 kWh of electricity and thus avoid approximately 270 tons of CO₂ annually. The remaining part of our electricity requirements comes from renewable energy sources and is 100 % CO₂-free green electricity.

First and foremost, we do everything we can to make our containers as durable as possible. Because what lasts a long time doesn't need to be replaced, and that saves raw materials and energy. That is our understanding of sustainability.





2024



Tanks made with passion

Speidel Tank- und Behälterbau GmbH
Krummenstraße 2
72131 Ofterdingen
Phone +49(0)7473 9462-0
Fax +49(0)7473 9462-99
verkauf@speidel-behaelter.de

Do you know all the
SPEIDEL products?



www.speidels-braumeister.de



www.speidels-hausmosterei.de



www.speidel-regenwasser.de



www.speidel-edelstahlbehaelter.de

**MADE IN
GERMANY**

www.wagnerwagner.de